



# CUPRA ATECA

OWNER'S MANUAL



## Vehicle identification data

Model:
Vehicle Registration:
Vehicle identification number:
Date of vehicle registration or vehicle delivery:
SEAT Official Service/CUPRA authorised service:
Service advisor:
Telephone:

## Confirmation of receipt of documentation and vehicle keys

The following items were delivered with the vehicle:	YES	NO
On-board documentation	<input type="checkbox"/>	<input type="checkbox"/>
First key	<input type="checkbox"/>	<input type="checkbox"/>
Second key	<input type="checkbox"/>	<input type="checkbox"/>
Correct working order of all keys was checked	<input type="checkbox"/>	<input type="checkbox"/>
Location:		
Date:		
Signature of owner:		

## Introduction

Thank you for your trust choosing a CUPRA vehicle.

With your new CUPRA, you will be able to enjoy a vehicle with state-of-the-art technology and top quality features.

We recommend reading this Instruction Manual carefully to learn more about your vehicle so you can enjoy all its benefits in your daily driving.

Information about handling is complemented with instructions regarding the operation and maintenance of the vehicle in order to ensure its safety and maintain its value. Moreover, we want to give you valuable advice and tips to drive your vehicle efficiently and respecting the environment.

We wish you safe and enjoyable motoring.

## CUPRA

### WARNING

**Read and always observe safety information concerning the passenger's front airbag»» page 32, Fitting and using child seats.**

## About this manual

This instruction manual is valid for all variants and versions of your CUPRA model. It describes all equipment and models without specifying whether they are optional equipment or model variants. As a result, equipment not fitted to your vehicle or only available in certain countries may be described. Find out about your vehicle's equipment in the documentation supplied with it and please contact your CUPRA Specialised Service or SEAT Official SEAT Service if you require more detailed information.

All information provided in instruction manual corresponds to the information available at the time of going to press. As the vehicle is under continuous development, it may have differences to the data included in this manual. For this reason, no claims can be made in the event of mismatching data, illustrations and descriptions.

Ensure that the on-board documentation is kept in the vehicle at all times if you sell it or lend it to third parties. In addition, CUPRA recommends resetting the infotainment system to factory settings to delete all personal data.

Some details on the **drawings** may vary from its vehicle and must be interpreted as a standard representation.

The **direction indicators** (left, right, forwards, backwards) in this manual refer to the travel direction of the vehicle unless otherwise stated.

This instruction manual has been written for **left-hand drive vehicles**. In right-hand drive vehicles, the arrangement of the controls differs partly from that shown in the illustrations or described in the texts.

Technical modifications to the vehicle or safety-critical issues that have arisen since the time of going to press will be included in a supplement to the on-board documentation.

- ® **Trademarks** are marked with ®. The absence of this symbol does not guarantee that the term is not a trademark.
- >> It indicates that the section continues on the next page.

You can access the information in this manual using:

- Thematic table of contents that follows the manual's general chapter structure.
- Visual table of contents that uses graphics to indicate the pages containing "essential" information, which is detailed in the corresponding chapters.
- Alphabetical index with many terms and synonyms to help you find information.

### WARNING

Texts after this symbol contain information about safety and warn you about possible accident or injury risks.

### CAUTION

Texts after this symbol indicate possible damage to the vehicle.

### For the sake of the environment

Texts after this symbol contain information about the protection of the environment.

### Note

Texts after this symbol contain additional information.

## Digital instruction manual

The digital version of the manual can be found on the official CUPRA website:



- scan the QR code»» **Fig. 1**
- **OR** enter the following address in the navigator website:

<http://www.cupraofficial.com/owners/cupra-car-model-manuals.html>

and select your vehicle.

## Valid for the Dutch market

Only CUPRA Specialized Services can repair CUPRA vehicles and provide services under warranty.



# Table of Contents

<b>General views of the vehicle</b> .....	7	Jump start .....	50	<b>Seats and headrests</b> .....	123
Exterior view .....	7	Tow start and towing .....	51	Adjusting seats .....	123
Exterior view .....	8	<b>Fuses and bulbs</b> .....	56	Headrest .....	125
Overview (left hand drive) .....	9	Fuses .....	56	Seat functions .....	126
Overview (right hand drive) .....	10	Changing bulbs .....	59	<b>Transport and practical equipment</b> .....	129
Interior view .....	11	<b>Operation</b> .....	63	Storing objects .....	129
<b>Safety</b> .....	12	<b>Controls and displays</b> .....	63	Luggage compartment .....	130
<b>Safe driving</b> .....	12	Interior view .....	63	Roof carrier .....	136
Advice about driving .....	12	<b>Instruments and warning/control lamps</b> .....	64	Storage compartment .....	138
Correct sitting position of vehicle occupants .....	13	Instrument panel .....	64	Power sockets .....	140
Pedal area .....	16	Using the instrument panel .....	78	<b>Air conditioning</b> .....	142
<b>Seat belts</b> .....	16	Control lamps .....	80	Heating, ventilation and cooling .....	142
The whys and wherefores of seat belts .....	16	Infotainment system .....	82	<b>Infotainment system</b> .....	150
How to properly adjust your seat belt .....	19	Multifunction steering wheel .....	87	<b>Introduction</b> .....	150
Seat belt tensioners .....	21	<b>Opening and closing</b> .....	88	First steps .....	150
PreCrash system .....	22	Set of vehicle keys .....	88	Overview and controls .....	154
<b>Airbag system</b> .....	23	Central locking .....	90	General instructions for use .....	155
Brief introduction .....	23	Anti-theft alarm system .....	97	<b>Data transfer</b> .....	161
Operation of the airbags .....	25	Doors .....	99	CUPRA CONNECT .....	161
<b>Transporting children safely</b> .....	30	Rear lid .....	101	Full Link .....	166
Child safety .....	30	Window controls .....	106	WLAN access point .....	170
<b>Emergencies</b> .....	40	Sunroof .....	108	<b>Infotainment operation</b> .....	172
<b>Self-help</b> .....	40	<b>Lights</b> .....	111	voice control .....	172
Information, assistance and emergency call service .....	40	Vehicle lighting .....	111	Radio mode .....	174
Emergency equipment .....	41	Interior lights .....	118	Media Mode .....	178
Tyre repairs .....	42	<b>Visibility</b> .....	118	Navigation .....	181
Changing a wheel .....	44	Windscreen wiper and rear window wiper systems .....	118	Telephone interface .....	188
Changing the windscreen wiper blades .....	48	Mirrors .....	121	Multimedia .....	193
		Sun protection .....	123	<b>Driving</b> .....	195
				<b>Start and driving</b> .....	195
				Starting and stopping the engine .....	195
				Start-Stop system .....	199
				DSG automatic transmission .....	201
				Gear-change recommendation .....	208

## Table of Contents

Hill Descent Control (HDC) .....	208	Peripheral view system (Top View Camera) .....	268	<b>Information for the user</b> .....	325
Steering .....	209	Reverse Assist (Rear View Camera) .....	272	<b>Information for the user</b> .....	325
Driving modes (Drive Profile) .....	210	<b>Towing bracket device</b> .....	274	Information stored by the control units .....	325
Driving tips .....	212	Trailer mode .....	274	Other important information .....	325
<b>Driver assistance systems</b> .....	216	Electrically unlocking trailer hook .....	281	Information about the EU Directive 2014/53/EU .....	326
General notes .....	216	Retrofitting a towing bracket .....	283	<b>Technical data</b> .....	331
Driver assistance sensors and cameras .....	217	<b>Practical tips</b> .....	285	<b>Indications about the technical data</b> .....	331
Cruise control system (CCS) .....	220	<b>Checking and refilling levels</b> .....	285	Important information .....	331
Speed limiter .....	221	Refuelling .....	285	<b>Index</b> .....	337
emergency brake assistance system (Front Assist) .....	223	Fuel types .....	286		
ACC - Adaptive Cruise Control .....	226	Engine management and emissions control system .....	287		
Proactive speed adjustment .....	232	Engine compartment .....	289		
Lane Assist .....	234	Engine oil .....	292		
Driving Assist (Travel Assist) .....	236	Cooling system .....	295		
Emergency Assist .....	238	Brake fluid .....	297		
Side Assist with Rear Cross Traffic Alert (RCTA) .....	240	Windscreen washer reservoir .....	298		
<b>Braking and parking</b> .....	245	12-volt battery .....	299		
Braking system .....	245	Energy management .....	301		
Stabilisation and brake assistance systems .....	249	<b>Wheels</b> .....	303		
Parking .....	252	Wheels and tyres .....	303		
<b>Help with parking and manoeuvring</b> .....	253	Tyre pressure monitor system .....	310		
Assisted parking system (Park Assist) .....	253	Spare wheel .....	312		
Parking aid parking and manoeuvring (ParkPilot) .....	259	<b>Maintenance</b> .....	314		
Parking System Plus .....	261	<b>Service</b> .....	314		
Rear parking aid .....	264	Service intervals .....	314		
Trailer Assist .....	266	Additional service offers .....	316		
		Warranty .....	317		
		<b>Vehicle maintenance</b> .....	317		
		Maintenance and cleaning .....	317		
		<b>Accessories and modifications to the vehicle</b> .....	322		
		Accessories, spare parts and repair work ..	322		



## Exterior view

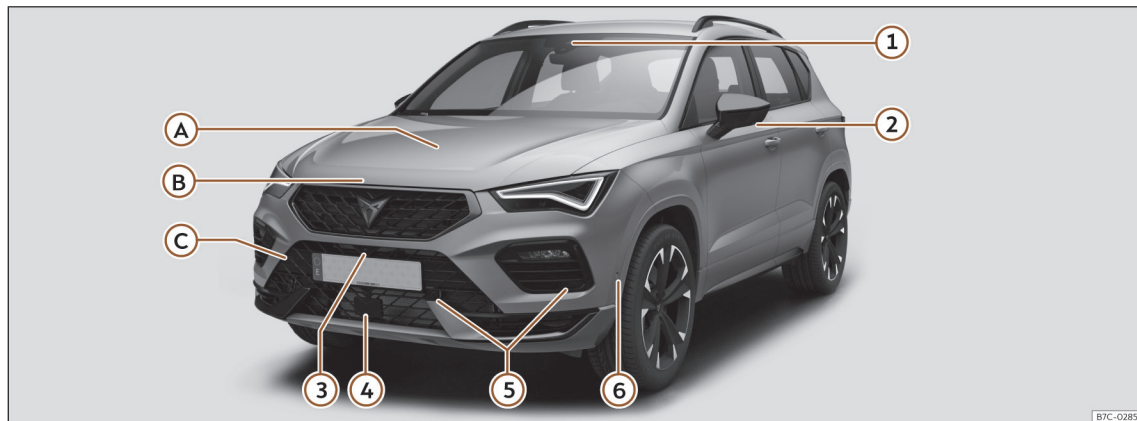

B7C-0285

### Driving assistance sensors»» page 216

- ① Front multifunction camera
- ② Rear-view cameras "Area View"
- ③ Front camera "Area View"
- ④ Front radar
- ⑤ Park distance control sensors
- ⑥ Park assist sensor

### Ⓐ Levels control

- Oil»» page 292
- Brake fluid»» page 297
- Battery»» page 299

### Ⓑ Bonnet

- Unlocking lever»» page 290
- Open/close»» page 290

### Ⓒ Towing the vehicle

- Towline anchorage»» page 54
- Tow-start»» page 52

## Exterior view

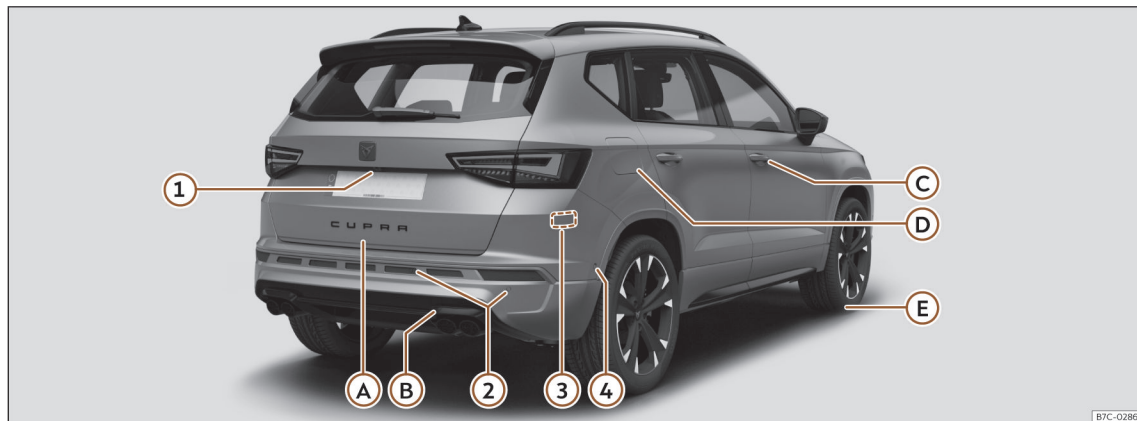

B7C-0285

## Driving assistance sensors»» page 216

- ① Rear view camera
- ② Park distance control sensors
- ③ Rear radars
- ④ Park assist sensor

## A Rear lid

- Opening from outside»» page 102
- Emergency opening»» page 105

## B Towing the vehicle

- Towline anchorage»» page 54
- Tow-start»» page 52

## C Opening and closing

- Doors»» page 99
- Central locking»» page 90
- Emergency lock»» page 100

## D Fuel tank

- Fuel capacity»» page 331
- Open/Close cap»» page 285

## E Action in the event of a puncture

- Anti-puncture kit»» page 42
- Wheel change»» page 44

## Overview (left hand drive)

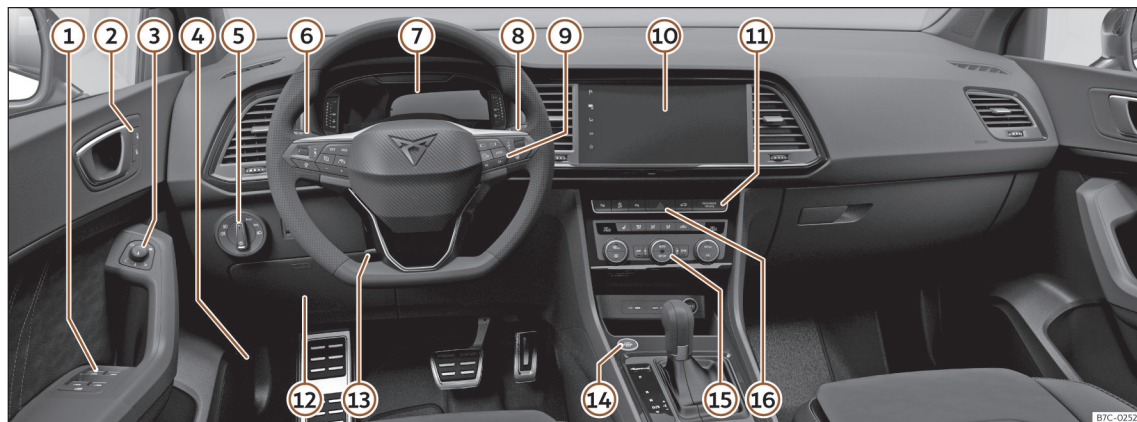

① Electric windows»» page 106

② Central locking»» page 90

③ Exterior mirror adjustment»» page 121

④ Open bonnet lever»» page 290

⑤ Headlight switch»» page 111

⑥ Turn signal and main beam lever  
»» page 113

Cruise control»» page 220

⑦ Warning lamps»» page 80

⑧ Wipers and rear window wiper  
»» page 118

⑨ Driver information system»» page 78

⑩ Infotainment system»» page 82,  
»» page 150

⑪ Front passenger airbag disconnection  
display»» page 27

⑫ Fuses»» page 56

⑬ Steering wheel adjustment»» page 15

⑭ Starter button»» page 195

⑮ Air conditioning»» page 142

⑯ Hazard warning lights»» page 116

## Overview (right hand drive)

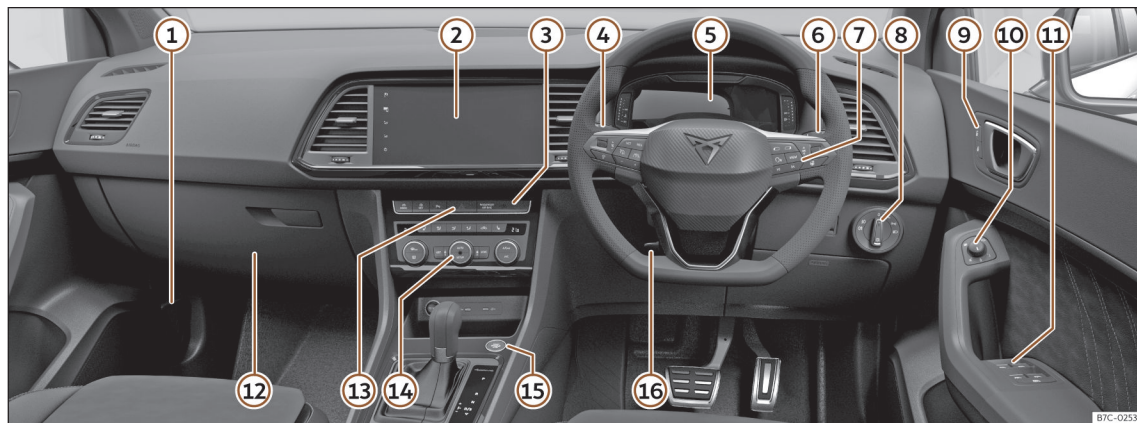

- |   |   |                                       |
|---|---|---------------------------------------|
| ① Open bonnet lever»» page 290                              | ⑤ Warning lamps»» page 80                     | ⑪ Electric windows»» page 106         |
| ② Infotainment system»» page 82                             | ⑥ Wipers and rear window wiper<br>»» page 118 | ⑫ Fuses»» page 56                     |
| ③ Front passenger airbag disconnection<br>display»» page 27 | ⑦ Driver information system»» page 78         | ⑬ Hazard warning lights»» page 116    |
| ④ Turn signal and main beam lever<br>»» page 113            | ⑧ Headlight switch»» page 111                 | ⑭ Air conditioning»» page 142         |
| Cruise control»» page 220                                   | ⑨ Central locking»» page 90                   | ⑮ Starter button»» page 195           |
|   | ⑩ Exterior mirror adjustment»» page 121       | ⑯ Steering wheel adjustment»» page 15 |

## Interior view



① Armrest»» page 135

② Isofix anchors»» page 33

③ Headrest adjustment»» page 125

④ Seat belts»» page 16

⑤ Panoramic roof»» page 108

⑥ Interior mirror»» page 121

⑦ Disconnecting the front passenger front airbag»» page 27

⑧ Electronic parking brake»» page 247

# Safety

## Safe driving

### Advice about driving

#### Safety first!

##### WARNING

- This manual contains important information about the operation of the vehicle, both for the driver and the passengers. The other sections of the on-board documentation also contain further information that you should be aware of for your own safety and for the safety of your passengers.
- Ensure that the on-board documentation is kept in the vehicle at all times. This is especially important when lending or selling the vehicle to another person.

#### Before driving

For your own safety and the safety of your passengers, always note the following points before every trip:

- Make sure that the vehicle's lights and turn signals are working properly.
- Check tyre pressure.

- Ensure that all windows provide a clear and good view of the surroundings.
- Make sure all luggage is secured >>> page 129.
- Make sure that no objects can interfere with the pedals.
- Adjust front seat, headrest and mirrors properly according to your size.
- Ensure that the passengers in the rear seats always have the headrests in the in-use position >>> page 125.
- Instruct passengers to adjust the headrests according to their height.
- Protect children with appropriate child seats and properly applied seat belts >>> page 30.
- Assume the correct sitting position. Instruct your passengers also to assume a proper sitting position >>> page 13.
- Fasten your seat belt securely. Instruct your passengers also to fasten their seat belts properly >>> page 16.
- Always pay attention to traffic and do not get distracted by passengers or telephone calls.
- Never drive when your driving ability is impaired (e.g. by medication, alcohol, drugs).
- Observe traffic laws and speed limits.
- Always reduce your speed as appropriate for road, traffic and weather conditions.
- When travelling long distances, take breaks regularly - at least every two hours.
- If possible, avoid driving when you are tired or stressed.

##### WARNING

Driving under the influence of alcohol, drugs, medication or narcotics may result in severe accidents and even loss of life.

- Alcohol, drugs, medication and narcotics may significantly alter perception, affect reaction times and safety while driving, which could result in the loss of control of the vehicle.

#### Factors influencing safety

As a driver, you are responsible for yourself and your passengers.

#### Safety equipment

Never put your safety or the safety of your passengers in danger. In the event of an accident, the safety equipment may reduce the risk of injury. The following points cover

part of the safety equipment in your CUPRA<sup>1)</sup>:

- three-point seat belts,
- belt tension limiters for the front and rear side seats,
- belt tensioners for the front and rear side seats,
- front airbags,
- knee airbags,
- side airbags in the front seat backrests,
- head-protection airbags,
- "ISOFIX" anchor points for "ISOFIX" rear child seat system
- height-adjustable front head restraints<sup>2)</sup>,
- rear headrests with in-use position and non-use position,
- adjustable steering column.

The safety equipment mentioned above works together to provide you and your passengers with the best possible protection in the event of an accident. However, these safety systems can only be effective if you and your passengers are sitting in a correct position and use this equipment properly.

### Safety is everyone's business!

<sup>1)</sup> Depending on the version/market.

<sup>2)</sup> The front seats with built-in headrests do not require adjustment.

## Correct sitting position of vehicle occupants

### Correct position on the seat

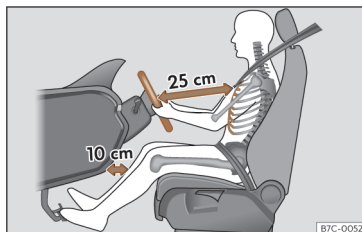

**Fig. 2** The correct distance between the driver and the steering wheel must be at least 25 cm (10 inches).

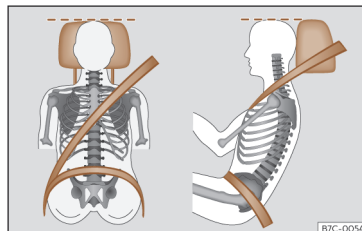

**Fig. 3** Correct belt web and headrest positions

The correct sitting positions for the driver and passengers are shown below.

If your physical constitution prevents you from maintaining the correct sitting position, contact a specialised workshop for help with any special devices. The seat belt and airbag can only provide optimum protection if a correct sitting position is adopted. CUPRA recommends taking your car in for technical service.

For your own safety and to reduce the risk of injury in the event of an accident or sudden braking or manoeuvre, CUPRA recommends the following positions: »

**Valid for all vehicle occupants:**

- Adjust the headrest so that its upper edge is at the same level as the top of your head, or as close as possible to the same level as the top of your head and under no circumstances below eye level. Keep the back of your neck as close as possible to the headrest»» Fig. 3.
- Short people must lower the headrest completely, even if your head is below its upper edge.
- Tall people must raise the headrest completely.
- Always keep your feet in the footwell while the vehicle is in motion.
- Adjust and fasten your seat belt correctly »» page 19.

**The following also applies to the driver:**

- Move the seat backrest to an almost upright position so that your back rests completely against it.
- Move the steering wheel so it is at least 25 cm (10 inches) away from the steering wheel»» Fig. 2 and you can hold it with both hands on both sides, on the outer part, with your arms slightly bent.
- The steering wheel must always point towards the chest and never towards the face.
- Move the seat in such a way that you can step on the pedals with your knees slightly

bent and with a distance between the knees and the dashboard of at least 10 cm (4 inches)»» Fig. 2.

- Adjust the height of the seat so that you can reach the top of the steering wheel.
- Always keep both feet in the footwell so that you have the vehicle under control at all times.

**For the passenger, the following applies:**

- Move the seat backrest to an almost upright position so that your back rests completely against it.
- Move the seat as far back as possible (minimum 25 cm between the chest and the dashboard check translation). If you are sitting closer than 25 cm, the airbag system cannot protect you properly.

**Number of seats**

The vehicle has 5 seats, 2 in the front and 3 in the rear. All seats are equipped with a safety belt.

In some versions, your vehicle is approved **only** for 4 seats. 2 front seats and 2 rear seats.

**⚠ WARNING**

**Sitting in an incorrect position may increase the risk of severe or lethal injuries in**

**the event of sudden braking or manoeuvring, in case of collision or accident and if the airbags deploy.**

- Before starting the car, all passengers must be sitting in a correct position and stay like that for the entire journey. This also applies to a correct use of the seat belt.
- The maximum amount of people in the vehicle is the same as the amount of seats with seat belts.
- For children, always use a certified protection system, certified and suited for their weight and height»» page 30.
- While driving, always keep your feet in the footwell. Never place them over the seat or the dashboard, for example, or outside the window. Otherwise the airbag and seat belt may offer insufficient protection and also increase the risk of injury in the event of an accident.

**Risks of sitting in an incorrect position**

If seat belts are worn incorrectly or not at all, the risk of severe or lethal injuries increases. Seat belts can provide optimal protection only if the belt web is properly worn. Incorrect sitting positions substantially reduce the protective function of seat belts and, therefore, increase the risk of severe or even lethal injuries. The risk of severe or fatal



injuries is especially heightened when a deploying airbag strikes a vehicle occupant who has assumed an incorrect sitting position. The driver is responsible for all people, particularly children, inside the vehicle.

The following list contains examples of incorrect sitting positions that could be dangerous for all vehicle occupants.

### When the vehicle is in motion:

- Never stand in the vehicle.
- Never stand on the seats.
- Never kneel on the seats.
- Never tilt your seat backrest too far to the rear.
- Never lean against the dash panel.
- Never lie on the rear seats.
- Never sit on the front edge of a seat.
- Never sit sideways.
- Never lean out of a window.
- Never put your feet out of a window.
- Never put your feet on the dash panel.
- Never place your feet on the bench or on the backrest of the seat.
- Never travel in a footwell.
- Never sit on the armrests.
- Never travel without wearing the seat belt.
- Never travel in the luggage compartment.

### WARNING

Sitting in an incorrect position increases the risk of severe or fatal injuries in the event of accidents and sudden braking or manoeuvres.

- All occupants must sit correctly during the journey and wear the seat belt correctly.
- Occupants of the vehicle that are not sitting correctly, not wearing the seat belt or are not at a proper distance of the airbag risk suffering very serious or lethal injuries, especially if the airbags deploy and strike them.

### Steering wheel position adjustment

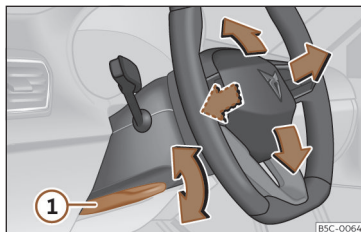

**Fig. 4** Lever in the lower left side of the steering column.

Adjust the steering wheel before your trip and only when the vehicle is stationary.

- Pull the **>>> Fig. 4 ①** lever down, move the steering wheel to the desired position and lift the lever back up until it locks.

### WARNING

Incorrect use of the steering wheel adjustment function and an incorrect adjustment of the steering wheel can result in severe or fatal injury.

- After adjusting the steering column, push the lever **>>> Fig. 4 ①** firmly upwards to ensure the steering wheel does not accidentally change position while driving.
- Never adjust the steering wheel while the vehicle is in motion. If you need to adjust the steering wheel while the vehicle is in motion, stop safely and make the proper adjustment.
- The adjusted steering wheel should be facing your chest and not your face so as not to hinder the driver's front airbag protection in the event of an accident.
- When driving, always hold the steering wheel with both hands on the outside of the ring at the 9 o'clock and 3 o'clock positions to reduce injuries when the driver's front airbag deploys.
- Never hold the steering wheel at the 12 o'clock position or in any other manner (e.g. in the centre of the steering wheel). In such cases, if the driver's airbag deploys,

»

you may sustain injuries to your arms, hands and head.

## Pedal area

### Pedals

- Ensure that you can always press the accelerator, brake and clutch pedals unimpaired to the floor.
- Ensure that the pedals can return unimpaired to their initial positions.
- Ensure that the floor mats are securely fastened during the trip and do not obstruct the pedals >>> 

Only use floor mats which leave the pedals clear and which are secured to prevent them from slipping. You can obtain suitable floor mats from a specialised dealership. Fasteners for floor mats are fitted in the footwells.

If a brake circuit fails, the brake pedal must be pressed down thoroughly in order to stop the vehicle.

### Wear suitable footwear

Always wear shoes which support your feet properly and give you a good feeling for the pedals.

### WARNING

- Restricting pedal operation can lead to critical situations while driving.
- Never lay or fit floor mats or other floor coverings over the original floor mats. This would reduce the pedal area and could obstruct the pedals. Risk of accident.
- Never place objects in the driver footwell. An object could move into the pedal area and impair pedal operation.

## Seat belts

### The whys and wherefores of seat belts

#### Control lamps



It lights up red

Driver or passenger has not fastened seat belt.

The control lamp  lights up to remind the driver to fasten their seat belt.

Before starting the vehicle:

- Fasten your seat belt securely.
- Instruct your passengers to fasten their seat belts properly before driving off.
- Protect children by using a child seat according to the child's height and weight >>> page 30.

When starting to drive, if the vehicle's speed exceeds approx. 25 km/h (15 mph) and the seat belts are not fastened or are unfastened while driving, a warning sound will be heard for a few seconds. The warning light will also flash .



The lamp  goes out when the driver and passenger seat belts are fastened with the ignition switched on.

## Rear seat belts fastened display



**Fig. 5** Instrument panel: left rear seat occupied and corresponding seat belt fastened display.

Depending on the model version, when the ignition is switched on, the seat belt status display» **Fig. 5** on the instrument panel informs the driver whether the passengers in the rear seats have fastened their seat belts.

-  It indicates that the corresponding seat is empty.
-  Indicates that the seat is occupied and the occupant is wearing the seat belt.

The seat belt status flashes for a maximum of 60 seconds when a seat belt in the rear seats is unfastened while the vehicle is in motion. An audible warning will also be heard if the vehicle is travelling at over 25 km/h (15 mph).

If a seat belt is fastened or unfastened while driving in some of the rear seats, the seat

belt status is displayed for approximately 30 seconds.

## The protective function of seat belts



**Fig. 6** Drivers with properly worn seat belts will not be thrown forward in the event of sudden braking.

Properly worn seat belts hold the occupants in the proper position. They also help prevent uncontrolled movements that may result in serious injury and reduce the risk of being thrown out of the vehicle in case of an accident.

Vehicle occupants wearing their seat belts correctly benefit greatly from the ability of the belts to absorb kinetic energy. In addition, the front part of your vehicle and other passive safety features (such as the airbag system) are designed to absorb the kinetic

energy released in a collision. Taken together, all these features reduce the releasing kinetic energy and consequently, the risk of injury. This is why it is so important to fasten seat belts before every trip, even when "just driving around the corner".

Ensure that your passengers wear their seat belts as well. Accident statistics have shown that wearing seat belts is an effective means of substantially reducing the risk of injury and improving the chances of survival when involved in a serious accident. Furthermore, properly worn seat belts improve the protection provided by airbags in the event of an accident. For this reason, wearing a seat belt is required by law in most countries.

Although your vehicle is equipped with airbags, the seat belts must be fastened and worn. The front airbags, for example, are only triggered in some cases of head-on collision. The front airbags will not be triggered during minor frontal or side collisions, rear-end collisions, overturns or accidents in which the airbag trigger threshold value in the control unit is not exceeded.

## Important safety instructions for the use of seat belts

- Always wear the seat belt as described in this section. »

- Ensure that the seat belts can be fastened at all times and are not damaged.

### **⚠ WARNING**

- If seat belts are worn incorrectly or not at all, the risk of severe injuries increases. The optimal protection from seat belts can be achieved only if you use them properly.
- Never allow two passengers (even children) to share the same seat belt.
- Never unbuckle a seat belt while the vehicle is in motion. Risk of fatal injury.
- The seat belt should never lie on hard or fragile objects (such as glasses or pens, etc.) because this can cause injuries.
- Do not allow the seat belt to be damaged or jammed, or to rub on any sharp edges.
- Never wear the seat belt under the arm or in any other incorrect position.
- Bulky and unfastened clothing (such as an overcoat over a sweater) impairs the proper fit and function of the seat belts, reducing their capacity to protect.
- The slot in the seat belt buckle must not be blocked with paper or other objects, as this can prevent the latch plate from engaging securely.
- Never use seat belt clips, fastening rings or similar items to alter the position of the belt webbing.
- Frayed or torn seat belts or damage to the connections, belt retractors or parts of

the buckle could cause severe injuries in the event of an accident. Therefore, you must check the condition of all seat belts at regular intervals.

- Seat belts which have been worn in an accident and have been stretched must be replaced by a specialised workshop. Renewal may be necessary even if there is no apparent damage. The belt anchorage should also be checked.
- Do not attempt to repair a damaged seat belt yourself. The seat belts must not be removed or modified in any way.
- The belts must be kept clean, otherwise the retractors may not work properly.

### Head-on collisions and the laws of physics



**Fig. 7** A driver not wearing a seat belt is thrown forward violently.



**Fig. 8** The unbelted passenger in the rear seat is thrown forward violently, hitting the driver who is wearing a seat belt.

The effects of the laws of physics in the case of a head-on collision are easy to explain: the moment a vehicle starts moving, a type of energy called “kinetic energy” starts acting on both the vehicle and its passengers.

The amount of “kinetic energy” depends on the speed of the vehicle and on the weight of the vehicle and of its passengers. The higher they are, the more energy there is to be “absorbed” in the event of an accident.

The most significant factor, however, is the speed of the vehicle. If the speed doubles from 25 km/h (15 mph) to 50 km/h (30 mph), for example, the corresponding kinetic energy is multiplied by four.

Given that the passengers of the vehicle in our example do not have their seat belts fastened, in the event of a collision the entire

amount of the passengers' kinetic energy will be only absorbed by the mentioned impact.

Even at speeds of 30 km/h (19 mph) to 50 km/h (30 mph), the forces acting on bodies in a collision can easily exceed one tonne (1000 kg). At greater speed these forces are even higher.

Vehicle occupants not wearing seat belts are not "attached" to the vehicle. In a head-on collision, they will move forward at the same speed their vehicle was travelling just before the impact. This example applies not only to head-on collisions, but to all accidents and collisions.

Even at low speeds the forces acting on the body in a collision are so great that it is not possible to brace oneself with one's hands. In a frontal collision, unbelted passengers are thrown forward and will make violent contact with the steering wheel, dash panel, windscreen or whatever else is in the way »» Fig. 7.

It is also important for rear passengers to wear seat belts properly, as they could otherwise be thrown forward violently through the vehicle interior in an accident. Passengers in the rear seats who do not use seat belts endanger not only themselves but also the front occupants»» Fig. 8.

## How to properly adjust your seat belt

### Fastening and unfastening the seat belt

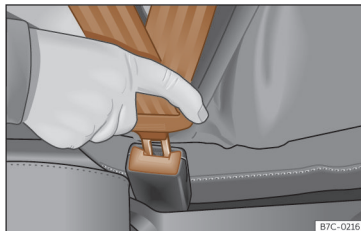

**Fig. 9** Insert the latch plate of the seat belt into the buckle.

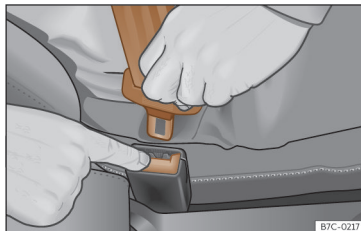

**Fig. 10** Release the seat belt's buckle.

Properly worn seat belts hold the vehicle occupants in the position that most protects them in the event of an accident or sudden braking »» △.

### Fastening the seat belt

Fasten your seat belt before each trip.

- Adjust the front seat and headrest correctly»» page 13.
- Engage the seat backrest of the rear seat in an upright position »» △.
- Pull the latch plate and place the belt webbing evenly across your chest and lap. Do **not** twist the seat belt when doing so »» △.
- Engage the latch plate in the buckle of the corresponding seat»» Fig. 9.
- Pull the belt to ensure that the latch plate is securely engaged in the buckle.

### Releasing the seat belt

Only unfasten the seat belt when the vehicle has come to a standstill »» △.

- Press the red button on the buckle »» Fig. 10. The latch plate is released from the buckle.
- Guide the belt back by hand so that it rolls up easily and the trim will not be damaged. »

**⚠ WARNING**

- The seat belt cannot offer its full protection unless the seat backrest is in an upright position and the seat belt is worn correctly, according to your size.
- Unbuckling your seat belt while the vehicle is in motion can cause severe or fatal injuries in the event of an accident or sudden braking.
- The seat belt itself, or a loose seat belt, can cause severe injuries if the belt moves from hard areas of the body to soft areas (e.g. the stomach).

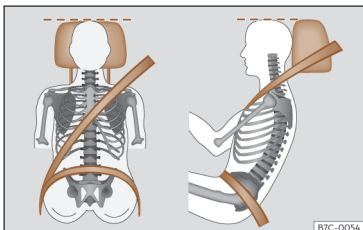
**Correct seat belt position**

**Fig. 11** Correct seat belt and headrest positions, viewed from front and the side.

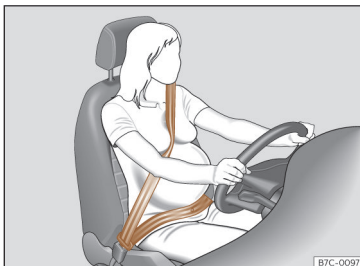

**Fig. 12** Position of seat belt during pregnancy.

Seat belts offer their maximum protection in the event of an accident and reduce the risk of sustaining severe or fatal injuries only when they are properly positioned. Furthermore, if the webbing is correctly positioned, the seat belt will hold the vehicle occupants in the optimum position to ensure the airbag provides the maximum protection. The seat belt must therefore always be worn and the webbing correctly positioned.

Incorrectly worn seat belts can cause severe or even fatal injuries»» page 13, Correct sitting position of vehicle occupants.

- The shoulder part of the seat belt must lie on the centre of the shoulder, never across the neck or the arm, under the arm or behind the shoulder.

- The lap part of the seat belt must lie across the pelvis, never across the stomach.
- The seat belt must lie flat and fit comfortably. Pull the belt tight if necessary to take up any slack.

In the case of **pregnant women**, the seat belt must lie evenly across the chest and as low as possible over the pelvis, never across the stomach and must be worn properly at all times during the pregnancy»» **Fig. 12**.

**Adapting the position of the belt webbing to your size**

The position of the seat belt can be adapted by adjusting the height of the front seats.

**⚠ WARNING**

An incorrectly worn seat belt web can cause severe or fatal injuries in the event of an accident.

- The shoulder part of the seat belt must lie on the centre of the shoulder, never across the neck or the arm.
- The seat belt must lie flat and fit comfortably on the torso
- The lap part of the seat belt must lie across the pelvis, never across the stomach. The seat belt must lie flat and fit comfortably on the pelvis Pull the belt tight if necessary to take up any slack.
- For pregnant women, the lap part of the seat belt must lie as low as possible over the

pelvis and always lie flat, “surrounding” the stomach»» Fig. 12.

- Do not twist the seat belt while it is fastened.
- Once the seat belt is positioned correctly, don't pull it away from your body with your hand.
- Do not lie the seat belt across rigid or fragile objects, e.g. glasses, pens or keys.
- Never use seat belt clips, retaining rings or similar instruments to alter the position of the belt webbing.

#### **i** Note

If your physical constitution prevents you from maintaining the correct position of the belt webbing, contact a specialised workshop for help with any special devices to ensure the optimum protection of the seat belt and airbag. CUPRA recommends taking your car in for technical service.

## Seat belt tensioners

### How the seat belt tensioner works

The seat belts for the front seats and the side rear seats<sup>1)</sup> are equipped with belt tensioners.

The belt tensioners are activated by sensors, although only in severe head-on, lateral and rear-end collisions.

This retracts and tightens the seat belts, reducing the forward motion of the occupants.

The belt pre-tensioners work in combination with the airbag system. In case of overturn, the pre-tensioners do not activate unless the head airbags are deployed.

### Reversible seat belt tensioning

In specific driving situations, a reversible tensioning of the seat belts might take place »» page 22. For example:

- in the event of sudden brakes
- in the event of oversteering or understeering
- in the event of minor collisions

#### **i** Note

- If the seat belt tensioners are triggered, a fine dust is produced. This is normal and it is not an indication of fire in the vehicle.
- The relevant safety requirements must be observed when the vehicle or components of the system are scrapped. Specialised workshops are familiar with these regulations, which are also available to you.

### Maintenance and disposal of seat belt tensioners

The belt tensioners are components of the seat belts that are installed in the seats of your vehicle. If you work on the belt tensioners or remove and install parts of the system when performing other repair work, the seat belt may be damaged. The consequence may be that, in the event of an accident, the belt tensioners function incorrectly or may not function at all.

So that the effectiveness of the seat belt tensioner is not reduced and that removed parts do not cause any injuries or environmental pollution, regulations, which are known to the specialised workshops, must be observed. »»

<sup>1)</sup> Depending on version/market.

**⚠ WARNING**

- Improper use or repairs not carried out by qualified mechanics increase the risk of severe or fatal injuries. The belt tensioners may fail to trigger or may trigger in the wrong circumstances.
- The seat belt tensioner, seat belt and automatic retractor cannot be repaired.
- Any work on the belt tensioners and seat belts, including the removal and refitting of system parts in conjunction with other repair work, must be performed by a specialised workshop only.
- The belt tensioners will only provide protection for one accident and must be changed if they have been activated.

**🌿 For the sake of the environment**

Airbag modules and belt tensioners may contain perchlorate. Observe the legal requirements for their disposal.

## PreCrash system

### How it works

The PreCrash system is an assistance system that activates a series of measures to protect the occupants of the vehicles in potentially risky situations, but which cannot prevent a collision.

It only works completely if no special driving profile is selected and if there are no operating anomalies.

### Basic features

Depending on the legal provisions of the country and the features of the vehicle, in critical situations (e.g. in certain cases of emergency braking or loss of control of the vehicle by the driver) the following functions can be activated separately or at the same time when the vehicle is travelling faster than approximately 30 km/h (20 mph).

- Reversible tensioning of front seat belts that are fastened.
- Operation of the hazard warning lights.
- Automatic closing of the windows until they are just cracked open and, depending on the equipment, of the sunroof.

Depending on how critical the driving situation is, the belts are either tightened individually, or both belts at the same time.

### In addition to Front Assist

In vehicles with Front Assist»» page 223 , within the limits of the system, information is assessed on the risk of collision with the vehicle in front. The functions of the PreCrash system may also be activated if there is a high likelihood of a rear-end collision, or during the activation of Front Assist.

### In addition to Side Assist

In vehicles with lane assist»» page 240 , within the limitations of each system, information is assessed on the risk of collision with traffic to the rear of the vehicle. If a rear-end collision is highly likely, the functions of the PreCrash system may also be activated. In this situation, the hazard warning lights are turned on with a higher frequency of flashes.

### In addition to the Emergency Assist system

In vehicles with emergency assist, driver status information is assessed within the limitations of this system. The following PreCrash systems may be activated if a lack of activity is detected:

- Reversible seat belt tensioning of the driver's seat belt.
- Automatic closing of the windows until they are just cracked open and, depending on the equipment, of the sunroof.

### Activation of the PreCrash system

The PreCrash system can be partially deactivated by deactivating the traction and / or stability control, depending on the equipment. When these vehicle safety controls are switched on (by default, every time the ignition is turned on), the system is fully activated.



### Driving profile selection settings

In vehicles with driving profile selection, PreCrash adapts to suit the special vehicle configuration of the corresponding profile >>> page 210.

### Limited operation

The PreCrash system is not available or only has limited availability in the following situations:

- When the ASR and/or the ESC are disconnected.
- When driving in reverse.
- When the airbag control unit is not operating properly.
- When there is a fault in the system itself, in the ESC or in the Front Assist.

### Problems and solutions

If the PreCrash is not working correctly, the message **System unavailable** or **System with limited features** is shown permanently on the dashboard display. Go to a specialized CUPRA Service or Official SEAT Service and ask for the system to be checked.

#### WARNING

The PreCrash system cannot overcome the limits imposed by the laws of physics; it only works within the limits of the system. Risks

that compromise safety are never justified by the use of this system. The system is not a replacement for driver awareness and cannot prevent a collision.

- Adapt your speed and safe distance to the vehicle in front of you at all times to suit the visibility, weather, road and traffic conditions.
- The system is not always able to recognise objects.
- The system may not react to people or animals or objects that cross length-wise or that are hard to detect.
- Metallic objects (e.g. fences) or other elements of the public road or adverse weather conditions can hinder its operation and thus its ability to detect collision risk.
- Never ignore the warning lamps that light up or the messages shown on the dashboard.

#### WARNING

Distracting the driver in any way can lead to an accident and cause injuries.

- Never change settings on the Infotainment System while driving.

## Airbag system

### Brief introduction

#### Why is it so important to wear a seat belt and to sit correctly?

For the inflating airbags to achieve the best protection, the seat belt must always be worn properly and the correct sitting position must be assumed.

The airbag system is not a substitute for seat belts, but it is an integral part of the vehicle's overall passive safety system. Please bear in mind that the airbag system can only work effectively when the vehicle occupants are wearing their seat belts correctly and have adjusted the headrests properly. Therefore, it is most important to properly wear the seat belts at all times, not only because this is required by law in most countries, but also for your safety >>> page 16, The whys and wherefores of seat belts.

The airbag inflates in a matter of seconds, so if you are not properly seated when the airbag is triggered, you may sustain fatal injuries. Therefore, it is essential that all vehicle occupants assume a correct sitting position while travelling.

Sharp braking before an accident may cause a passenger not wearing a seat belt to be

»

thrown forward into the area of the deploying airbag. In this case, the inflating airbag may inflict critical or fatal injuries on the occupant. This also applies to children.

Always maintain the greatest possible distance between yourself and the front airbag. This way, the front airbags can completely deploy when triggered, providing their maximum protection.

The most important factors for triggering the airbag are the type of accident, the angle of impact and the vehicle speed.

Whether or not the airbags are activated depends primarily on the vehicle deceleration rate resulting from the collision and detected by the control unit. If the vehicle deceleration occurring during the collision and measured by the control unit remains below the specified reference values, the front, side and/or head-protection airbags will not be triggered. Take into account that the visible damage in a vehicle involved in an accident, no matter how serious, is not a determining factor for the airbags to have been activated.

### WARNING

- Wearing the seat belt incorrectly or assuming an incorrect sitting position can lead to critical or fatal injuries.
- All vehicle occupants, including children, who are not properly belted can sustain critical or fatal injuries if the airbag is trig-

gered. Children up to 12 years old should always travel on the rear seat. Never transport children in the vehicle if they are not restrained or the restraint system is not appropriate for their age, size or weight.

- To reduce the risk of injury from an inflating airbag, always wear the seat belt properly»» page 16.

### Description of the airbag system

The airbag system offers additional protection for the occupants in combination with the seat belts.

#### The airbag system comprises the following modules (as per vehicle equipment):

- Electronic control unit
- Front airbags for driver and passenger
- Knee airbag for the driver
- Side airbags
- Head airbag
- Airbag control lamp  on the instrument panel»» page 25
- Key-operated switch for front passenger airbag
- Control lamp for disabled/enabled status of the front passenger airbag.

The airbag system operation is monitored electronically. The airbag control lamp will illuminate for a few seconds every time the ignition is switched on (self-diagnosis).

#### There is a fault in the system if the control lamp :

- does not light up when the ignition is switched on»» page 25,
- turns off after 4 seconds after the ignition is switched on,
- turns off and then lights up again after the ignition is switched on,
- illuminates or flashes while the vehicle is moving.

#### The airbag system is not triggered if:

- the ignition is switched off
- there is a minor frontal collision
- there is a minor side collision
- there is a rear-end collision
- the vehicle turns over.

### WARNING

- The seat belts and airbags can only provide maximum protection if the occupants are seated correctly»» page 13.
- If a fault has occurred in the airbag system, have the system checked immediately by a specialised workshop. Otherwise there is a danger that during a collision, the

system may fail to trigger, or not trigger correctly.

### Airbag activation

The airbags deploy extremely rapidly, within thousands of a second, to provide additional protection in the event of an accident. A fine dust may develop when the airbag deploys. This is normal and it is not an indication of fire in the vehicle.

The airbag system is only ready to function when the ignition is on.

In special accidents instances, several airbags may activate at the same time.

In the event of minor head-on and side collisions, rear-end collisions, overturning or roll-over of the vehicle, airbags **do not activate**.

#### Activation factors

The conditions that lead to the airbag system activating in each situation cannot be generalised. Some factors play an important role, such as the properties of the object the vehicle hits (hard/soft), angle of impact, vehicle speed, etc.

Deceleration trajectory is key for airbag activation.

The control unit analyses the collision trajectory and activates the respective restraint system.

If the deceleration rate is below the predefined reference value in the control unit the airbags will not be triggered, even though the accident may cause extensive damage to the car.

#### The following airbags are triggered in serious head-on collisions:

- Driver airbag.
- Front passenger front airbag
- Knee airbag for the driver.

#### The following airbags are triggered in serious side-on collisions:

- Front side airbag on the side of the accident.
- Curtain (head) airbag on the side of the accident.

#### In an accident with airbag activation:

- the interior lights switch on (if the interior light switch is in the courtesy light position);
- the hazard warning lights switch on;
- all doors are unlocked;
- the fuel supply to the engine is cut;
- an emergency call is started.

## Operation of the airbags

### Airbag system control lamps



**It lights up on the combi-instrument**

Fault in the airbag system and seat belt tensioners .  
Have the system checked immediately by a specialised workshop.

**OFF**



**It lights up on the dash panel**

Fault in the airbag system.  
Have the system checked immediately by a specialised workshop.

Front passenger front airbag deactivated.  
Check if the airbag should be kept deactivated

**ON**







**It lights up on the dash panel**

Front passenger front airbag activated.  
The control lamp turns off automatically 60 seconds after the ignition is switched on

Several warning and control lamps light up for a few seconds when the ignition is switched on, signalling that the function is being verified. They will switch off after a few seconds.

If the airbag and seat belt tensioner system control lamp remains on or flashes, it indicates a malfunction in the airbag and seat belt tensioner system >>> Have the system >>

checked immediately by a specialised workshop.

If the front passenger airbag is deactivated, the warning lamp **PASSENGER AIR BAG OFF**  remains lit on the dash panel to remind you that the airbag is deactivated. If, with the front passenger airbag deactivated, this lamp **does not remain lit** or if it is lit along with the control lamp  on the instrument panel, there is a fault in the airbag system >>> . If the control lamp is flashing, there is a fault in the disabling of the airbag system >>> . Have the system checked immediately by a specialised workshop.

#### WARNING

In the event of a fault in the airbag and seat belt tensioner system, the airbags and seat belts may not trigger correctly, may fail to trigger or may even trigger unexpectedly.

- The vehicle occupants run the risk of sustaining severe or fatal injuries. Have the system checked immediately by a specialised workshop.
- Do not mount a child seat in the front passenger seat or remove the mounted child seat! The front passenger front airbag may deploy during an accident in spite of the fault.

#### CAUTION

Always pay attention to any lit control lamps and to the corresponding descrip-

tions and instructions to avoid damage to the vehicle or harm to the occupants.

### Front airbags

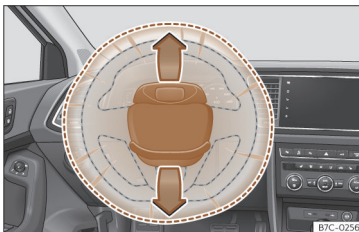

**Fig. 13** Driver airbag located in steering wheel.



**Fig. 14** Front passenger airbag located in dash panel.

The driver's front airbag is housed in the steering wheel and that of the front passenger, on the dash panel. Airbags are identified by the word "AIRBAG".

When the driver and front passenger airbags are deployed, the covers remain attached to the steering wheel and dashboard, respectively >>> **Fig. 13** >>> **Fig. 14**.

In conjunction with the seat belts, the front airbag system gives the front occupants additional protection for the head and chest in the event of a severe frontal collision >>> .

Their special design allows the controlled escape of the propellant gas when an occupant puts pressure on the bag. Thus, the head and chest are protected by the airbag. After the collision, the airbag deflates sufficiently to allow visibility.

#### WARNING

- The deployment space between the front passengers and the airbags must not in any case be occupied by other passenger, pets and objects.
- The airbags provide protection for just one accident; replace them once they have deployed.
- It is also important not to attach any objects such as cup holders or telephone mountings to the surfaces covering the airbag units.

### Activate and deactivate front passenger front airbag



**Fig. 15** Switch for activating and deactivating the front passenger airbag.







**Fig. 16** Dash panel: control lamp for the deactivation of the front passenger front airbag.

Deactivate the front passenger front airbag only if you have to use a rear-facing child seat in the front passenger seat.

CUPRA recommends fitting the child seat in the rear seat to avoid having to deactivate the front passenger airbag.

When the front passenger airbag is **deactivated**, this means that only the front passenger front airbag is deactivated. All the other airbags in the vehicle remain activated.

#### Deactivate and activate the front passenger front airbag

- Switch the ignition off.
- Open the door on the front passenger side.
- Insert the key into the slot of the switch for deactivating the front passenger airbag >>> **Fig. 15**. About 3/4 of the key should enter; this is as far as it will go.
- Turn the key gently to change its position to **OFF** (deactivate) or to **ON** (activate). If you have difficulty, ensure that you have inserted the key as far as it will go.
- Close the front passenger door.
- When deactivating the airbag, switch the ignition on and check that the control lamp **OFF**  remains lit where it says **PASSENGER AIR BAG OFF**  in the central part of the dashboard >>> **Fig. 16**.
- When reactivating the airbag, check that when the ignition is switched on, the **OFF**  control lamp does not light up and the **ON** 

lamp lights up for 60 seconds and then turns off.

#### **WARNING**

- The driver of the vehicle is responsible for disabling or switching on the airbag.
- Always switch off the ignition before disabling the front passenger airbag! Failure to do so could result in a fault in the airbag deactivation system.
- Never leave the key in the airbag disabling switch as it could get damaged or enable or disable the airbag during driving.
- If for any reason an airbag is deactivated, reactivate it as soon as possible so that it can fulfil its protective function.

## Knee airbag



**Fig. 17** On the driver side: location of the knee airbag



**Fig. 18** On the driver side: airbag action radius for the knees.

The knee airbag is located on the driver side below the dash panel» **Fig. 17**. Airbags are identified by the word “AIRBAG”.

The framed area (deployment area) » **Fig. 18** is covered by the knee airbag when

it is deployed. Objects should never be placed or mounted in this area.

### ⚠ WARNING

- The knee airbag is deployed in front of the driver's knees. Always keep the deployment areas of the knee airbags free.
- Never not fix objects to the cover or in the deployment area of the knee airbag.
- Adjust the driver's seat so that there is a distance of at least 10 cm (4 inches) between your knees and the location of this airbag. If your physical constitution prevents you from meeting these requirements, make sure you contact a specialised workshop.

## Side airbags

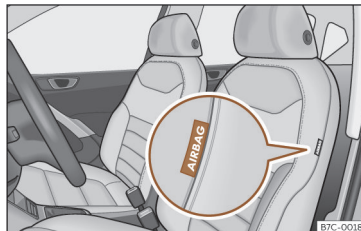

**Fig. 19** Side airbag in driver's seat.

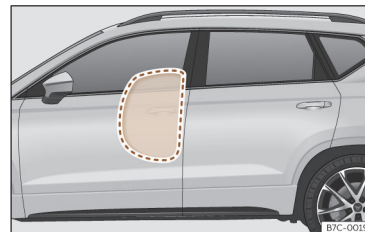

**Fig. 20** Illustration of completely inflated side airbags on the left side of the vehicle.

The side airbags are located in the driver's seat and front passenger seat backrests » **Fig. 19**.

Its location is marked with the word “AIRBAG” on the upper part of the back of the seats or on the lower coverings with the word AIRBAG in relief.

In conjunction with the seat belts, the side airbag system provides additional protection for the upper body in the event of a severe side collision » **Fig. 19**.

In a side collision, the side airbags reduce the risk of injury to passengers to the areas of the body facing the impact. In addition to their normal protection, the seat belts also hold the passengers in the event of a side collision; this is how these airbags provide maximum protection.

**⚠ WARNING**

- If you do not wear a seat belt, if you lean forward, or are not seated correctly while the vehicle is in motion, you are at a greater risk of injury if the side airbag system is triggered in an accident.
- In order for the side airbags to provide their maximum protection, the prescribed sitting position must always be maintained with seat belts fastened while travelling.
- In a side-on collision the side airbags will not work if the sensors do not correctly measure the pressure increase on the interior of the doors, due to air escaping through the areas with holes or openings in the door panel.
- Never drive if the interior door panels have been removed or if the panels have not been correctly fitted.
- Never drive the vehicle if the loudspeakers in the door panels have been removed, unless the holes left by the loudspeakers have been closed properly.
- Always check that the openings are closed or covered if loudspeakers or other equipment are fitted inside the door panels.
- Occupants of the outer seats must never carry any objects or pets in the deployment space between them and the airbags, or allow children or other passengers to travel in this position. It is also important not to attach any accessories (such as cup holders)

to the doors. This would impair the protection offered by the side airbags.

- The built-in coat hooks should be used only for lightweight clothing. Do not leave any heavy or sharp-edged objects in the pockets.
- Great forces, such as hard blows or kicks, must not be exerted upon the backrest bolster because the system may be damaged. In this case, the side airbags would not be triggered.
- Under no circumstances should protective covers be fitted over seats with side airbags unless the covers have been approved for use in your vehicle. Because the airbag deploys from the side of the backrest, the use of conventional seat covers would obstruct the side airbag, seriously reducing the airbag's effectiveness.
- Any damage to the original seat upholstery or around the seams of the side airbag units must be repaired immediately by a specialised workshop.
- The airbags provide protection for just one accident; replace them once they have deployed.
- Any work on the side airbag system or removal and installation of the airbag components for other repairs (such as removal of the front seat) should only be performed by a specialised workshop. Otherwise, faults may occur during the airbag system operation.

**Head-protection airbags**

**Fig. 21** Location of head-protection airbags.

The head-protection airbags are located on both sides in the interior above the doors >>> **Fig. 21** and are identified with the text "AIRBAG".

In conjunction with the seat belts, the head-protection airbag system gives the vehicle occupants additional protection for the head and upper body in the event of a severe side collision >>> **⚠**.

The framed area is covered by the head-protection airbag when it is deployed (deployment area) >>> **Fig. 21**. Therefore, objects should never be placed or mounted in this area >>> **⚠**.

In the event of a side collision the head-protection airbag is triggered on the impact side of the vehicle. **»**

The head-protection airbags reduce the risk of injury to passengers in the front and rear side seats facing the impact.

### WARNING

- In order for the head-protection airbags to provide their maximum protection, the prescribed sitting position must always be maintained with seat belts fastened while travelling.
- For safety reasons, the head-protection airbag must be disabled in those vehicles fitted with a screen dividing the interior of the vehicle. See your technical service to make this adjustment.
- There must be no other persons, animals or objects between the occupants of the outer seats and the deployment space of the head-protection airbags so that the head-protection airbag can deploy completely without restriction and provide the greatest possible protection. Therefore, sun blinds which have not been expressly approved for use in your vehicle may not be attached to the side windows.
- The built-in coat hooks should be used only for lightweight clothing. Do not leave any heavy or sharp-edged objects in the pockets. Please, do not hang the clothes on coat hangers.
- The airbags provide protection for just one accident; replace them once they have deployed.

- Any work on the head-protection airbag system or removal and installation of the airbag components for other repairs (such as removal of the roof lining) should only be performed by a specialised workshop. Otherwise, faults may occur during the airbag system operation.
- The side and head airbags are managed through sensors located in the interior of the front doors. To ensure the correct operation of the side and head-protection airbags neither the doors nor the door panels should be modified in any way (e.g. fitting loudspeakers). If the front door is damaged, the airbag system may not work correctly. All work carried out on the front door must be done in a specialised workshop.

## Transporting children safely

### Child safety

#### Introduction

For safety reasons, as we have learned from accident statistics, we recommend that children under 12 years of age travel in the rear seats. Depending on their age, height and weight, children travelling in rear seats must use a child seat or a seat belt. For safety reasons, the child seat should be installed in the rear seat, behind the front passenger seat or in the centre back seat.

The physical laws involved and the forces acting in a collision apply also to children >>> page 18. But unlike adults, children do not have fully developed muscle and bone structures. This means that children are subject to a greater risk of injury.

To reduce the risk of injuries, children must always use special child restraint systems when travelling in the vehicle.

These systems have been especially designed and approved, complying with the ECE-R44. regulation.



CUPRA recommends securing the child seats shown on the website as described below:

- Child seats in the opposite direction of travel (group 0+): ISOFIX and support bracket (Peke GO Plus + ISOFIX Base (RWF)).
- Child seats in the direction of travel (group 1): ISOFIX and Top Tether (Peke G1 ISOFIX DUO Plus).
- Child seats directed towards the front of the vehicle (group 2): safety belt and ISOFIX (ROMER BRITAX KIDFIX<sup>2</sup> S).
- Child seats facing in the direction of travel (group 3): with safety belt (ROMER BRITAX KIDFIX<sup>2</sup> S).

Follow the manufacturer's instructions and observe any statutory requirements when installing and using child seats. Always read and note»» page 32.

We recommend you always carry the manufacturer's Child Seat Instruction Manual together with the on-board documentation.

### Child seats group classification



Fig. 22 Examples of child seats.

Use only child seats that are officially approved and suitable for the child.

These seats are subject to the ECE-R44 or ECE-R129 standards. ECE-R stands for: Economic Commission for Europe Regulation.

#### Child seats by weight group

The child seats are grouped into 5 categories:

Age group	Weight of the child
Group 0	Up to 10 kg
Group 0+	Up to 13 kg
Group 1	From 9 to 18 kg
Group 2	From 15 to 25 kg
Group 3	From 22 to 36 kg

Child seats that have been tested and approved under the ECE R44 or ECE-R129 standards bear the ECE-R44 or ECE-R129 test marks on the seat (the letter E in a circle with the test number below it).

Follow the manufacturer's instructions and observe any statutory requirements when installing and using child seats.

We recommend you to always include the manufacturer's Child Seat Instruction Manual together with the on-board documentation.

CUPRA recommends you use child seats from the **Original Accessories Catalogue**. These child seats have been designed and tested for use in our vehicles. You can find the right child seat for your model and age group at our dealers.

#### Child seats by approval category

Child seats may have the approval category of universal, semi-universal, vehicle specific (all according to the ECE-R44 standard) or i-Size (according to the ECE-R129 standard).

- **Universal:** child seats with universal approval can be installed in all vehicles. There is no need to consult any list of models. In the case of universal approval for ISOFIX, the child seat is additionally provided with a Top Tether belt.
- **Semi-universal:** semi-universal approval, in addition to the standard requirements of »

universal approval, requires safety devices to lock the child seat, which require additional testing. Child seats with semi-universal approval include a list of vehicle models for which they can be installed.

- **Vehicle-specific:** vehicle-specific approval requires a dynamic test of the child seat for each vehicle model separately. Child seats with vehicle-specific approval also include a list of vehicle models for which they can be installed.
- **i-Size:** child seats with i-Size approval must meet the requirements prescribed in the ECE-R 129 standard in relation to installation and safety. Child seat manufacturers can tell you which seats have i-Size approval for this vehicle.

### Fitting and using child seats



**Fig. 23** Airbag sticker: on the passenger's sun visor



**Fig. 24** Airbag sticker: on the rear frame of the passenger side door

### Warnings about fitting a child seat

Take the following general warnings into account if you are going to fit a child seat. They are valid for all child seats regardless of their attachment system.

- Please read and follow the child seat manufacturer's operating instructions.
- The child seat should preferably be fitted to the rear seat behind the front passenger seat so that the child can exit the vehicle on the pavement side.
- Set the height of the seat belt such that it adapts to the child seat naturally, without twisting. The lowest position of the seat belt height regulator must be used with rear-facing child seats.

- To correctly use a child seat in the back, the front backrest must be adjusted so that there is no contact with the child seat in the back in the case that it goes opposite to the direction of the car. In the case of front-facing restraint systems, the front backrest must be adjusted so that there is no contact with the child's feet.
- For a correct assembly of the child's seat on the rear seats, adjust or dismount the headrest, in order to prevent contact with the seat.
- If a semi-universal type chair is to be installed, in which the method of attachment to the car is through the seat belt and support bracket, it should never be installed in the central rear seat as the ground clearance is lower than in other places and the support bracket will not allow the seat to remain sufficiently stable.
- When fitting a child seat on the front passenger seat, the seat must be moved backwards as far as possible and placed in the

highest position. The backrest must also be put in a vertical position<sup>1)</sup>.

### Important information about the front passenger front airbag

A sticker with important information about the passenger airbag is located on the passenger's sun visor and/or on the passenger side door frame»» Fig. 23.

Read and always observe the safety information included in the following chapters:

- Safety distance with respect to the passenger airbag»» page 23.
- Objects between the passenger and the passenger side airbag »» ⚠ in Front airbags on page 26.

The passenger side front airbag, when enabled, is a serious risk for a child that is facing backward since the airbag can strike the seat with such force that it can cause serious or fatal injuries. Children up to 12 years old should always travel on the rear seat.

Therefore we strongly recommend you to transport children on the rear seats. This is the safest location in the vehicle. Alternatively, the front passenger airbag can be dis-

abled with a key-operated switch»» page 27. When transporting children, use a child seat suitable for the age and size of each child »» page 31.

### ⚠ WARNING

- If a child seat is secured to the front passenger seat, the risk to the child of sustaining critical or fatal injuries in the event of an accident increases.
- An inflating front passenger airbag can strike the rear-facing child seat and project it with great force against the door, the roof or the backrest.
- Never install a child seat facing backwards on the front passenger seat unless the front passenger front airbag has been disabled. Risk of potentially fatal injuries to the child! However, if necessary, the front passenger front airbag must be deactivated »» page 27. If the passenger seat has a height adjustment option, move it to the highest, most upright position. If you have a fixed seat, do not install any child restraint system in this location.
- For those vehicles that do not include a key lock switch to deactivate the airbag, the vehicle must be taken to a technical service. Do not forget to reconnect the airbag

when an adult wants to sit in the front passenger seat.

- Never allow a child to be transported in a vehicle without being properly secured, or to stand up or kneel on a seat while traveling. In an accident, the child could be flung through the vehicle, causing possibly fatal injuries to themselves and to the other vehicle occupants.
- Never leave a child alone in the child seat or in the vehicle.
- Children who are less than 1.5 metres tall must not wear a normal seat belt without a child seat, as this could cause injuries to the abdominal and neck areas during a sudden braking manoeuvre or in an accident.
- When a child seat is mounted in the rear seats, the door child-proof lock should be activated»» page 101.

### Attachment systems

Depending on the country, different attachment systems are used for safely installing child seats. »»

<sup>1)</sup> Compliance with current national legislation and the manufacturer's instructions is required when using or installing child seats.

### Attachment systems overview

- **ISOFIX:** ISOFIX is a standardised attachment system allowing quick and safe attachment of child seats in the vehicle. ISOFIX attachment establishes a rigid connection between the child seat and the car body.

The child seat has two rigid attachment clips, called connectors. These connectors are fitted into the ISOFIX attachment rings found between the seat cushion and the backrest of the vehicle's back seat (on the sides). ISOFIX attachment systems are used mainly in Europe»» page 35. If necessary, ISOFIX attachment may have to be supplemented with a Top Tether belt or a support bracket.

- **Automatic three-point seat belt.** Whenever possible, it is preferable to attach the child seats with the ISOFIX system rather than attaching them with an automatic three-point seat belt»» page 38.

Additional attachment:

- **Top Tether:** the Top Tether belt is guided over the back of the rear seat and attached to an anchor point with a hook. Anchor points are located at the back of the rear seat backrest on the boot side»» page 37. The rings for retaining the Top Tether belt are marked with an anchor symbol.
- **Support bracket:** some child seats rest on the floor of the vehicle with a support bracket. The support bracket prevents the child seat from tipping forward in the event of impact. Child seats fitted with a support bracket should only be used in the passenger seat and side rear seats »» ⚠. For the assembly of this type of seat you should also consult the list of approved vehicles for this assembly, available in the instructions for child restraint systems.

### Recommended systems for attaching child seats

CUPRA recommends attaching child seats as follows:

- **Baby carriers or child seats in the opposite direction of travel:** ISOFIX and support bracket or i-Size.
- **Child seats in the direction of travel:** ISOFIX and Top Tether.

#### WARNING

**Incorrect use of the support bracket can cause serious or fatal injury.**

- **Make sure the support bracket is correctly and safely installed.**

## Fit a child seat with the ISOFIX / i-Size and Top Tether system



**Fig. 25** Rear seat: ISOFIX/i-Size securing rings.

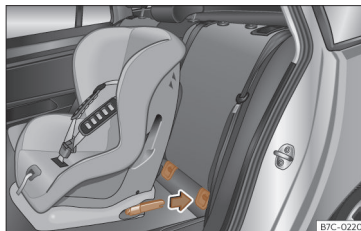

**Fig. 26** Rear seats: fitting a child seat with the ISOFIX system.

Child seats can be secured quickly, easily and safely on the rear side seats with the “ISOFIX” and Top Tether system.

Two “ISOFIX” retaining rings are fitted on each rear side seat. In some vehicles, the

rings are secured to the seat frame and, in others, they are secured to the rear floor. The “ISOFIX” rings are located between the rear seat backrest and the seat cushioning >>> **Fig. 25**. The Top Tether rings are located on the rear part of the rear seat backrests

(behind the backrest or in the luggage compartment) >>> page 37.

To understand the compatibility of the “ISOFIX” systems in the vehicle, check the table below.

### Vehicle ISOFIX positions

Weight group	Size class <sup>a)</sup>	Electrical equipment	Front passenger seat		Rear side seat	Rear central seat
			airbag enabled	airbag disabled		
Baby carrier	F	ISO/L1	X	X	X	X
	G	ISO/L2	X	X	X	X

IUF: Suitable for forward-facing ISOFIX universal child restraint systems approved for use in this weight group.

IL: It is suitable for certain ISOFIX child restraint systems (CRS) that can be for the specific vehicle, restricted or semi-universal categories. Take the child seat manufacturer's vehicle list into account.

X: ISOFIX position not suitable for ISOFIX child restraint systems for this weight group or size class.



## Safety

Weight group	Size class <sup>a)</sup>	Electrical equipment	Front passenger seat		Rear side seat	Rear central seat
			airbag enabled	airbag disabled		
Group 0 to 10 kg	E	ISO/R1	X	X	IL	X
Group 0+ to 13 kg	E	ISO/R1	X	X	IL	X
	D	ISO/R2	X	X	IL	X
	C	ISO/R3	X	X	IL	X
Group I 9 to 18 kg	D	ISO/R2	X	X	IL	X
	C	ISO/R3	X	X	IL	X
	B	ISO/F2	X	X	IUF/IL	X
	B1	ISO/F2X	X	X	IUF/IL	X
	A	ISO/F3	X	X	IUF/IL	X
Group II 15 to 25 kg	---	---	X	X	---	X
Group III 22 to 36 kg	---	---	X	X	---	X

IUF: Suitable for forward-facing ISOFIX universal child restraint systems approved for use in this weight group.

IL: It is suitable for certain ISOFIX child restraint systems (CRS) that can be for the specific vehicle, restricted or semi-universal categories. Take the child seat manufacturer's vehicle list into account.

X: ISOFIX position not suitable for ISOFIX child restraint systems for this weight group or size class.

<sup>a)</sup> The indication of class according to size corresponds to the authorised bodyweight for the child seat. In child seats with universal or semi-universal approval, the class according to size is indicated on the ECE approval label. The indication of class according to size is stated on the corresponding child seat.

## Vehicle i-Size positions

Front passenger seat		Rear side seat	Rear central seat
airbag enabled	airbag disabled		
X	X	i-U	X

i-U: Position suitable for forward- or rear-facing i-Size child restraint systems with universal certification.

X: Position not suitable for i-Size child restraint systems.

### Securing the child seat with the “ISOFIX/i-Size” system

You must follow the child seat manufacturer's instructions.

- Press the child seat onto the “ISO-FIX/iSize” retaining rings until it is heard to engage securely»» Fig. 26. If the child seat is equipped with Top Tether anchor points, secure it to the correspondent ring »» page 37. Follow the child seat manufacturer's instructions.
- Pull on both sides of the child seat to ensure that it is properly anchored.

Child seats with the “ISOFIX” and Top Tether attachment system are available from Technical Services.

#### **⚠ WARNING**

The securing rings are designed only for use with “ISOFIX” and Top Tether system child seats.

- Never secure other child seats that do not have the “ISOFIX” or Top Tether system, or safety belts or any other objects to the securing rings – as this can result in potentially fatal injuries to the child.
- Ensure that the child seat is correctly secured to the “ISOFIX” and Top Tether securing rings.

### Top Tether securing belts

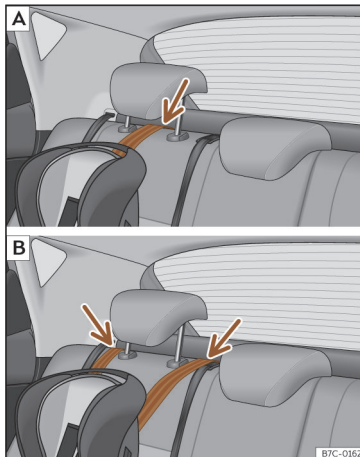

**Fig. 27** Rear seats: adjustment and assembly according to the Top Tether belt.

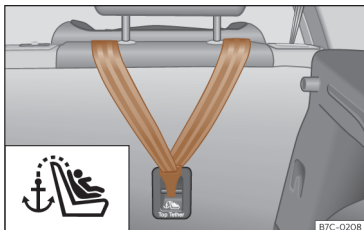

**Fig. 28** Back of the rear seats: Top Tether securing rings.

Child seats with the Top Tether system come with a strap for securing the seat to the vehicle anchor point, located at the back of the rear seat backrest and provide greater restraint.

The objective of this strap is to reduce forward movements of the child seat in a crash, to reduce the risk of injuries to the head from hitting the inside of the vehicle.

### Fitting a child seat using the seat belt

If you want to fit a universal approval category (U) child seat in your vehicle, you must check that the seat is approved for your ve-

### Using the Top Tether in rear-facing mounted seats

Currently, there are very few rear-facing child safety seats that have Top Tether. Please carefully read and follow the seat manufacturer instructions to learn the proper way to install the Top Tether strap.

### Securing the retainer strap

- Follow the manufacturer's instructions to deploy the child seat Top Tether retaining strap.
- Place the belt under the head restraint of the back seat»» **Fig. 27** (depending on the instructions of the chair itself, lift or remove the head restraint if necessary).
- Slide the strap and secure it properly with the anchorage of the backrest»» **Fig. 28**.
- Firmly tighten the strap following the manufacturer's instructions.

hicle. You will find any necessary information on the child seat's orange ECE approval la-

### Releasing the retaining strap

- Loosen the strap following the manufacturer's instructions.
- Push the lock and release it from the anchoring support.

### **⚠ WARNING**

An undue installation of the safety seat will increase the risk of injury in the event of a crash.

- **Never tie the retainer strap to a hook in the luggage compartment.**
- **Never secure or tie luggage or other items to the lower anchorages (ISOFIX) or the upper ones (Top Tether).**

bel. The following table shows the different fitting options.



## Transporting children safely

Weight group	Front passenger seat <sup>a)</sup>		Rear side seat	Rear central seat <sup>b)</sup>
	Airbag enabled	airbag disabled <sup>c)</sup>		
Group 0 to 10 kg	X	U	U	U
Group 0+ to 13 kg	X	U	U	U
Group I 9 to 18 kg	X	U	U	U
Group II 15 to 25 kg	X	UF	UF	UF
Group III 22 to 36 kg	X	UF	UF	UF

X: Not compatible for the installation of seats install chairs in this configuration.

U: Suitable for universal restraint systems for use in this weight group.

UF: Acceptable for front-facing universal-category child restraint systems approved for this mass group.

- a) Compliance with current national legislation and the manufacturer's instructions is required when using or installing child seats.
- b) For semi-universal chairs where the securing system is the car safety belt and the support bracket, do not use them in the centre rear seat.
- c) Seats **without** height adjustment should be placed in their rearmost position. Seats **with** height adjustment should be placed in their rearmost and highest position.

### Fitting a child seat using the seat belt

- Set the height of the seat belt such that it adapts to the child seat naturally, without twisting. The lowest position of the seat belt height regulator must be used with rear-facing child seats.
- Put the seat belt in place and pass it through the child seat according to the instructions of the child seat manufacturer.
- Make sure that the seat belt is not twisted.
- Insert the latch plate into the seat's buckle until you hear the engagement click.

### WARNING

When travelling, children must be secured in the vehicle with a restraint system suitable for age, weight and size.

- Read and always observe information and warnings concerning the use of child seats
- >>> page 32.

# Emergencies

## Self-help

### Information, assistance and emergency call service

#### How it works

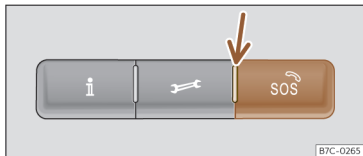

**Fig. 29** On the roof console: voice service controls

Depending on the equipment, there is a control on the roof console.

By pressing the buttons **i**, **🔧** and **SOS** >> **Fig. 29**, you can run the following voice services:

- information call
- assistance call
- emergency call service.

A built-in control unit establishes the connection.

When a voice service is activated, a connection is established with a phone line.

#### Control lamp

The control has a warning lamp >>> **Fig. 29** (arrow). It shows the following statuses:

- **Off**: the eCall service is not available.
- **Flashes red, approx. 20 seconds after switching on the ignition**: the eCall service is off.
- **Lights up red**: system failure. The eCall service is available with certain restrictions. CUPRA suggests going to a specialised workshop.
- **Lights up green**: the eCall service is available. The system works correctly.
- **Flashes green**: There is an ongoing voice connection.

#### **i** Information call<sup>1)</sup>

With the information call, a call is made to SEAT, S.A. customer service.

#### **🔧** Assistance call<sup>1)</sup>

With the assistance call you can directly request specialised help in the event of a breakdown.

Parallel to the voice call, some vehicle data is transmitted, e.g. your current location.

#### **SOS** Emergency call service<sup>1)</sup>

If an emergency call is conducted manually or activated automatically in the event of an accident with an airbag triggering, information relevant to the emergency is broadcast, e.g. the current location of the vehicle >>> **page 325**.

If the call is public, the person on the other end of the line uses the language of the country in which you are located.

If the call is private, the person on the other end of the line will assist you in the language you have configured in the Infotainment system. If the configured language is not available, English will be used.

#### **Diversion to 112 emergency number**

In some situations where the emergency call service is limited or cannot be carried out, an emergency call is made to 112.

<sup>1)</sup> Only available in certain countries.

The following conditions may cause the emergency call service to function in a limited manner or the call to be diverted to the 112 emergency number:

- The emergency call is made from an area with weak or no mobile and GPS signal, as well as e.g. tunnels, between very tall buildings, garages, underground walkways, mountains and valleys.
- In areas with sufficient mobile telephone and GPS coverage, the mobile telephone network of the telecommunications operator in question may not be available.
- In some countries, the emergency call service may not be available due to legal reasons. There is no valid license for the use of the emergency call service.
- The components of the vehicle required for the emergency phone call are damaged or do not get enough power.
- In some countries, the emergency call service may not be available and depending on the location of the vehicle, the control lamp LEDs, and even the operation of the different types of calls, could have a specific behaviour.

#### **i** Note

**Breakdown service and information calls can incur an additional cost on your telephone bill.**

## Emergency equipment

### Vehicle tool kit

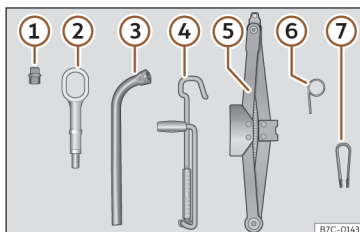

**Fig. 30** Underneath the floor panel of the luggage compartment: vehicle tool kit.

The vehicle tool kit is located under the floor panel in the luggage compartment. To access the vehicle tools >>> page 130.

The tool kit includes:

- ① Adapter for the anti-theft bolt
- ② Towing eye, removable
- ③ Wheel spanner
- ④ Crank handle for jack
- ⑤ Jack
- ⑥ Hook for extracting the central wheel trims
- ⑦ Clip for removing the wheel bolt caps

Some of the items listed are only provided in certain model versions, or are optional extras.

#### **⚠** WARNING

When the vehicle tool kit, tyre mobility set and spare wheel are loose in the interior they can be violently thrown in case of a sudden manoeuvre or braking and especially in accidents, causing serious injury.

- Ensure that the vehicle tool kit, the tyre mobility set and the spare wheel or temporary spare wheel are safely secured in the luggage compartment.

#### **⚠** WARNING

Unsuitable or damaged vehicle tools can cause injury or accidents.

- Never work with inappropriate or damaged tools.

#### **i** Note

The jack does not generally require any maintenance. If required, it should be greased using universal type grease.

## Tyre repairs

### TMS (Tyre Mobility System)

The Tyre Mobility System will reliably seal punctures caused by the penetration of a foreign body of up to about **4 mm** in diameter. **Do not remove foreign objects, e.g. screws or nails, from the tyre.**

After inserting the sealant residue in the tyre, you must again check the tyre pressure about 10 minutes after starting the engine.

You should only use the tyre mobility set if the vehicle is parked in a safe place, you are familiar with the procedure and you have the necessary tyre mobility set! Otherwise, you should seek professional assistance.

**Do not use the tyre sealant in the following cases:**

- If the wheel rim has been damaged.
- In outside temperatures below  $-20^{\circ}\text{C}$  ( $-4^{\circ}\text{F}$ ).
- In the event of cuts or perforations in the tyre greater than 4 mm.
- If you have been driving with very low pressure or a completely flat tyre.
- If the sealant bottle has passed its use by date.

#### WARNING

Using the tyre mobility system can be dangerous, especially when filling the tyre at the roadside. Please observe the following rules to minimise the risk of injury:

- Stop the vehicle safely as soon as possible. Park it at a safe distance from surrounding traffic to fill the tyre.
- Ensure the ground on which you park is flat and solid.
- All passengers and particularly children must keep a safe distance from the work area.
- Turn on the hazard warning lights to warn other road users.
- Use the tyre mobility system only if you are familiar with the necessary procedures. Otherwise, you should seek professional assistance.
- The tyre mobility set is intended for temporary emergency use only until you can reach the nearest specialised workshop.
- Replace the repaired tyre with the tyre mobility set as soon as possible.
- The sealant is a health hazard and must be cleaned immediately if it comes into contact with the skin.
- Always keep the tyre mobility set out of the reach of small children.
- Always switch off the engine, activate the electronic parking brake and place the se-

lector lever in P to reduce the risk of accidental vehicle movement.

#### WARNING

A tyre filled with sealant does not have the same performance properties as a conventional tyre.

- Never drive faster than 80 km/h (50 mph).
- Avoid heavy acceleration, hard braking and fast cornering.
- Drive for only 10 minutes at a maximum speed of 80 km/h (50 mph) and then check the tyre.

#### For the sake of the environment

Dispose of used or expired sealant observing any legal requirements.

#### Note

You can purchase a new bottle of tyre sealant in specialised CUPRA dealers or any SEAT dealership.

#### Note

Take into account the separate instruction manual of the tyre mobility system's manufacturer.

## Anti-puncture kit contents

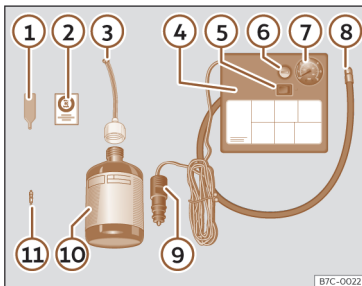

Fig. 31 Standard representation: anti-puncture kit contents.

The anti-puncture kit is located underneath the floor covering in the luggage compartment. It includes the following components >>> **Fig. 31**:

- ① Valve insert remover
- ② A sticker to be adhered to the instrument cluster, within the driver's visual field, to remind that the maximum advisable speed "max. 80 km/h" or "max. 50 mph"
- ③ Filler tube with cap
- ④ Air compressor (depending on the version, the model may vary).
- ⑤ ON/OFF switch

- ⑥ Air bleed screw (it can also be integrated in the inflator tube).
- ⑦ Warning provided by tyre pressure monitoring system (it can also be integrated in the inflator tube).
- ⑧ Tube for inflating tyres
- ⑨ 12 volt connector
- ⑩ Bottle of sealant
- ⑪ Spare tyre valve

The **valve insert remover** ① has a gap at the lower end for a valve insert. The valve insert can only be screwed or unscrewed in this way. This also applies to its replacement part ⑪.

## Sealing and inflating a tyre

### Sealing the tyre

- Unscrew the tyre valve cap and insert. Use the >>> **Fig. 31** ① tool to remove the insert. Place it on a clean surface.
- Shake the tyre sealant bottle vigorously >>> **Fig. 31** ⑩.
- Screw the inflator tube >>> **Fig. 31** ③ into the sealant bottle. The bottle's seal will break automatically.
- Remove the lid from the filling tube >>> **Fig. 31** ③ and screw the open end of the tube into the tyre valve.

- With the bottle upside down, empty all of the contents into the tyre.
- Remove the bottle from the valve.
- Place the insert back into the tyre valve using the tool >>> **Fig. 31** ①.

### Inflating the tyre

- Screw the compressor tyre inflator tube >>> **Fig. 31** ⑧ into the tyre valve.
- Check that the air bleed screw is closed >>> **Fig. 31** ⑥.
- Start the engine and leave it running.
- Insert the connector >>> **Fig. 31** ⑨ into the vehicle's 12-volt socket >>> **page 140**.
- Turn the air compressor on with the ON/OFF switch >>> **Fig. 31** ⑤.
- Keep the air compressor running until it reaches 2.0 to 2.5 bar (29-36 psi/200-250 kPa). **A maximum of 8 minutes.**
- Disconnect the air compressor.
- If it does not reach the pressure indicated, unscrew the tyre inflator tube from the valve.
- Move the vehicle 10m so that the sealant is distributed throughout the tyre.
- Screw the compressor tyre inflator into the valve.
- Repeat the inflation process.
- If the indicated pressure still cannot be reached, the tyre is too badly damaged. Stop >>

and request assistance from an authorised technician.

- Disconnect the air compressor. Unscrew the tyre inflator tube from the tyre valve.
- When the tyre pressure is between 2.5 and 2.0 bars, continue driving without exceeding 80 km/h (50 mph).
- Attach the sticker >>> Fig. 31 ② to the instrument cluster, within the driver's visual field.
- Check the pressure again after 10 minutes >>> page 44.

### ⚠ WARNING

When inflating the wheel, the air compressor and the inflator tube may become hot.

- Protect hands and skin from hot parts.
- Do not place the hot flexible inflator tube or hot air compressor on flammable material.
- Allow them to cool before storing the device.
- If it is not possible to inflate the tyre to at least 2.0 bars (29 psi / 200 kPa), the tyre is too badly damaged. The sealant is not in a good condition to seal the tyre. Do not continue driving. Seek specialist assistance.

### ⚠ CAUTION

Switch off the air compressor after a maximum of 8 operational minutes to avoid

**overheating!** Before switching on the air compressor again, let it cool for several minutes.

### Check after 10 minutes of driving

Screw the inflator tube >>> Fig. 31 ⑤ again and check the pressure on the gauge ⑥.

#### 1.3 bar (19 psi / 130 kPa) and lower:

- **Stop the vehicle!** The tyre cannot be sealed sufficiently with the tyre mobility set.
- You should obtain professional assistance >>> ⚠.

#### 1.4 bar (20 psi / 140 kPa) and higher:

- Set the tyre pressure to the correct value again.
- Carefully resume your journey until you reach the nearest specialised workshop without exceeding 80 km/h (50 mph).
- Have the damaged tyre replaced.

### ⚠ WARNING

Driving with an unsealed tyre is dangerous and can cause accidents and serious injury.

- Do not continue driving if the tyre pressure is 1.3 bar (19 psi / 130 kPa) and lower.
- Seek specialist assistance.

## Changing a wheel

### What to do first

- Park the vehicle on a horizontal surface and in a safe place as far away from traffic as possible.
- Apply the electronic parking brake.
- Switch on the hazard warning lights.
- Move the selector lever to the **P** position.
- If you are towing a trailer, unhitch it from your vehicle.
- Make sure that the vehicle tool kit >>> page 41 and the spare wheel >>> page 312 are ready.
- Observe the applicable legislation for each country (reflective vest, warning triangles, etc.).
- All occupants should leave the vehicle and wait in a safe place (for instance behind the roadside crash barrier).

### ⚠ WARNING

- Always observe the above steps and protect yourself and other road users.
- If you change the wheel on a slope, block the wheel on the opposite side of the car with a stone or similar to prevent the vehicle from moving.

## Wheel bolt caps



Fig. 32 Wheel: wheel nuts with caps.

## Removal

- Fit the plastic clip (vehicle tools) >>> Fig. 30 over the cap until it clicks into place >>> Fig. 32.
- Remove the cap with the plastic clip.

The caps protect the wheel nuts and should be remounted after changing the tyre.

The **anti-theft wheel locking bolt** has a special cap. This only fits on anti-theft locking bolts and is not for use with standard wheel nuts.

## Anti-theft wheel nuts

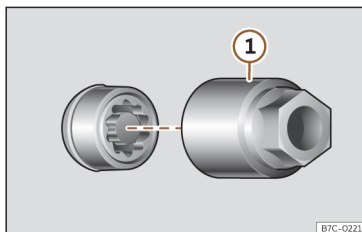

Fig. 33 Anti-theft wheel bolt with cap and adapter.

## Loosening the anti-theft wheel bolt

- Remove the wheel cover or the cap.
- Insert the special adapter >>> Fig. 33 ① (vehicle tools) >>> page 41 onto the anti-theft wheel bolt and push it on as far as it will go.
- Insert the wheel brace (vehicle tools) onto the adapter as far as it will go.
- Remove the wheel bolt >>> page 45.

**i** Note

Make a note of the code number of the anti-theft wheel bolt and keep it in a safe place, but not in your vehicle. If you need a new adapter, you can obtain it from the specialised CUPRA service or the SEAT Official Service, indicating the code number.

## Loosening wheel nuts



Fig. 34 Wheel change: loosen the wheel nuts.

Use only the wheel wrench belonging to the car to loosen the wheel nuts.

Loosen the wheel nuts only about one turn before raising the vehicle with the jack.

If the wheel bolt is very tight, carefully push on the end of the wheel wrench with your foot. Hold on to the vehicle for support and take care not to slip during this operation.

## Loosening wheel nuts

- Fit the wheel wrench on as far as it will go >>> Fig. 34.
- Hold the wrench at the end and rotate the bolt approximately one turn anticlockwise >>> ⚠.

»

### Important information about wheel nuts

Factory-fitted rims and wheel nuts are specially matched during construction. Therefore, if different rims are fitted, the correct wheel nuts with the right length and heads must be used. This ensures that wheels are fitted securely and that the brake system functions correctly.

In certain circumstances, you should not even use wheel nuts from vehicles of the same model.

#### WARNING

If the wheel nuts are not properly tightened, they could come loose while driving and cause an accident, serious injury and loss of vehicle control.

- Use only wheel nuts which correspond to the rim in question.
- Never use different wheel nuts.
- Wheel nuts and threads should be clean, free of oil and grease, and it should be possible to screw them easily.
- To loosen and tighten wheel nuts, only use the wheel wrench that came with the car from the factory.
- The wheel nuts should only be loosened slightly (about one turn) before raising the vehicle with the jack. Risk of accident!
- Never apply grease or oil to wheel nuts or to the wheel hub threads. Even if the bolts

have been tightened to the prescribed torque, they could come loose while driving.

- Never loosen the screwed joints of wheel rims with bolted ring trims.
- If wheel nuts are tightened below the prescribed torque, the bolts and rims could come loose while driving. If tightening torque is too high, the wheel nuts or threads can be damaged.

### Raise the vehicle

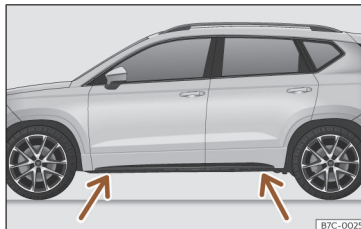

**Fig. 35** Jack position points.

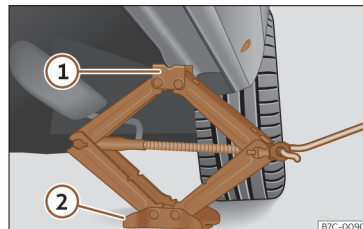

**Fig. 36** Cross member: positioning the jack on the vehicle.

- Rest the jack (vehicles tools) on firm ground. If necessary use a large, strong board or similar support. If the surface is slippery (for example tiles) place the jack on a rubber mat or similar to prevent it from slipping >>> .
- Find the support point on the strut (sunken area) closest to the wheel to be changed >>> **Fig. 35**.
- Turn the jack crank handle, located below the strut support point, to raise it until the tab **1** >>> **Fig. 36** is below the housing provided.
- Align the jack so that tab **1** "grips" onto the housing provided on the strut and the mobile base **2** is resting on the ground. The base plate **2** should fall vertically with respect to the support point **1**.
- Continue turning the jack until the wheel is slightly lifted off the ground.



**⚠ WARNING**

The factory-supplied jack is only designed for changing wheels on this model. On no account attempt to use it for lifting heavier vehicles or other loads. Risk of injury.

- Make sure the jack remains stable. If the surface is slippery or soft, the jack could slip or sink, respectively, with the consequent risk of causing injuries.
- Lift the vehicle using only the jack supplied from the factory. Other jacks, even those approved for other CUPRA models could slip, with the consequent risk of injury.
- Place the jack only at the support points provided on the strut and align it. Otherwise, the jack could slip because it does not have sufficient grip on the vehicle: risk of injury!
- You should never place a body limb such as an arm or leg under a raised vehicle that is solely supported by the jack.
- If you have to work underneath the vehicle, you must use suitable stands additionally to support the vehicle, there is a risk of accident!
- Never raise the vehicle if it is tilting to one side or the engine is running.
- Never start the engine when the vehicle is raised. The vehicle may come loose from the jack due to the engine vibrations.

**⚠ CAUTION**

The vehicle must not be raised on the crossbar. Place the jack only at the support points provided on the strut and align it. Otherwise, the vehicle may be damaged.

**Removing and installing a wheel**

Change the wheel after loosening the wheel nuts and raising the vehicle with the jack.

When removing/fitting the wheel, the rim may hit and damage the brake disc. For this reason, please take care and get a second person to assist you.

**Taking off the wheel**

- Unscrew the wheel nuts using the box spanner and place them on a clean surface.
- Take off the wheel.

**Putting on the spare wheel**

Check the direction of rotation of the tyre >>> page 48.

- Place the spare wheel or temporary spare wheel into position.
- Screw on the wheel nuts in position and tighten them loosely with a box spanner.
- To tighten the anti-theft locking wheel nuts use the corresponding adaptor.

- Carefully lower the vehicle using the jack.
- Use the wheel spanner to tighten all of the wheel nuts clockwise. Tighten the bolts in diagonal pairs (not in a circle).
- Put the caps, trim or full hubcap back on.

The wheel nuts should be clean and turn easily. Before fitting the spare wheel, inspect the wheel condition and hub mounting surfaces. These surfaces must be clean before fitting the wheel.

**Tightening torque of the wheel nuts**

The prescribed tightening torque for wheel nuts for steel and alloy wheels is **140 Nm**. After changing a wheel, have the tightening torque checked immediately with a torque wrench that is working perfectly.

**Before checking** tightening torque, have any rusty wheel nuts that are difficult to screw replaced and clean the wheel hub threads.

Never apply grease or oil to wheel nuts or to the wheel hub threads. Even if the bolts have been tightened to the prescribed torque, they could come loose while driving.

### Tyres with directional tread pattern

Tyres with directional tread pattern have been designed to operate best when rotating in only one direction. An arrow on the tyre sidewall indicates the direction of rotation on tyres with directional tread. Always observe the indicated direction of rotation in order to guarantee optimum grip and help avoid aquaplaning, excessive noise and wear.

If the tyre is mounted in the opposite direction of rotation, drive with extreme caution, as the tyre is no longer being used correctly. This is of particular importance when the road surface is wet. Change the tyre as soon as possible or remount it with the correct direction of rotation.

### Works after changing a wheel

- Replace the wheel bolt caps.
- Return all tools to their proper storing location.
- If the replaced wheel does not fit in the spare wheel housing, store it safely in the luggage compartment»» page 129 .
- Check the tyre pressure of the newly mounted tyre as soon as possible.

- In vehicles fitted with a tyre pressure indicator, adjust the pressure and store it in memory»» page 310 .
- Have the tightening torque of the wheel nuts checked as soon as possible with a torque wrench»» page 47 . Meanwhile, drive carefully.
- Have the flat tyre replaced as quickly as possible.

## Changing the windscreen wiper blades

### Wiper service position

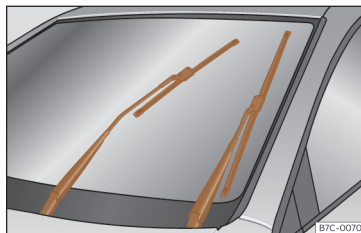

**Fig. 37** Wipers in service position.

Ensure that the wiper blades are not frozen. The wiper arms can be raised when the wipers are in service position»» **Fig. 37** .

- Close the bonnet»» page 289 .
- Switch the ignition on and off.
- Press the windscreen wiper lever downwards briefly»» page 118 (4).

Before driving, always lower the wiper arms. Using the windscreen wiper lever, the windscreen wiper arms return to their initial position.

#### Note

- The windscreen wiper arms can be moved to the service position only when the bonnet is properly closed.
- You can also use the service position, for example, if you want to fix a cover over the windscreen in the winter to keep it clear of ice.

## Changing the wiper rear wiper blades

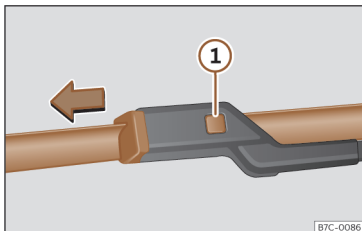

Fig. 38 Changing the windscreen wiper blades

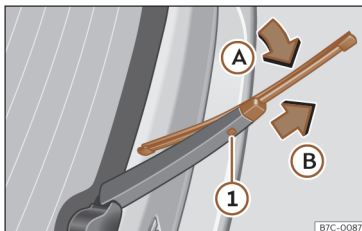

Fig. 39 Changing the rear wiper blade

The windscreen wiper blades are supplied as standard with a layer of graphite. This layer is responsible for ensuring that the wipe is silent. If the graphite layer is damaged, the

noise of the water as it is wiped across the windscreen will be louder.

Check the condition of the wiper blades regularly. **If the wipers scrape across the glass**, they should be changed if they are damaged, or cleaned if they are dirty >>> ❶.

If this does not produce the desired results, the setting angle of the windscreen wiper arms might be incorrect. They should be checked by a specialised workshop and corrected if necessary.

Damaged windscreen wiper blades should be replaced immediately. These are available from qualified workshops.

### Raising and lowering windscreen wiper arms

- Place the windscreen wipers in the service position >>> page 48.
- Grip the wiper arms **only** by the blade's fastening point.

### Cleaning windscreen wiper blades

- Raise the wiper arms.
- Use a soft cloth to remove dust and dirt from the windscreen wiper blades.
- If the blades are very dirty, a sponge or damp cloth may be used >>> ❶.

### Changing the windscreen wiper blades

- Lift and unfold the wiper arms.
- Press and hold release button >>> Fig. 38 ❶ and pull gently on the wiper blade in the direction of the arrow.
- Fit a new wiper blade of the **same length and design** on to the wiper arm and hook it into place.
- Rest the wiper arms back onto the windscreen.

### Changing the rear window wiper blade

- Lift and fold the wiper arm.
- Turn the blade slightly >>> Fig. 39 (arrow A).
- Hold down the release button ❶ while gently pulling the blade in the direction of arrow B.
- Insert a new blade of the **same length and type** in the rear wiper arm in the opposite direction to the arrow B and hook into place button ❶.
- Replace the wiper arm on the rear window.

### ⚠ WARNING

Worn or dirty windscreen wiper blades reduce visibility and increase the risk of accident and serious injury.

- Always replace damaged or worn windscreen wiper blades or blades that no longer clean the windscreen properly. »

### ⓘ CAUTION

- Damaged or dirty windscreen wipers could scratch the glass.
- If products containing solvents, rough sponges or sharp objects are used to clean the blades, the graphite layer will be damaged.
- Never use fuel, nail varnish remover, paint thinner or similar products to clean the windows.
- In icy conditions, always check that the wiper blades are not frozen to the glass before using the wipers. In cold weather, it may help to leave the vehicle parked with the wipers in service position»» page 48.

### ⓘ CAUTION

- To prevent damage to the bonnet and the wiper arms, only leave them in the service position.
- Before driving, always lower the wiper arms.

If the engine fails to start because of a discharged battery, the battery can be connected to the battery of another vehicle to start the engine.

Jump leads must comply with standard **DIN 72553** (see cable manufacturer's instructions). The wire cross section must be at least 25 mm<sup>2</sup> for petrol engines and at least 35 mm<sup>2</sup> for diesel engines.

### ⓘ Note

- The vehicles must not touch each other, otherwise electricity could flow as soon as the positive terminals are connected.
- The discharged battery must be properly connected to the on-board network.

### Jump start: description

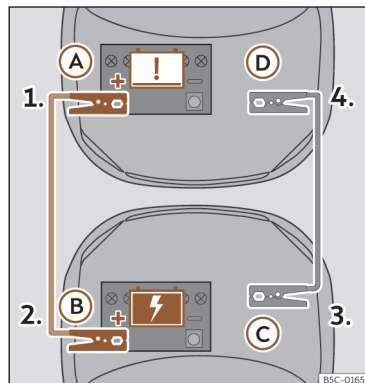

**Fig. 40** Diagram of connections for vehicles with Start-Stop system.

### Jump lead terminal connections

1. Switch off the ignition of both vehicles »» ⚠.
2. Connect one end of the *red* jump lead to the positive (+) terminal of the vehicle with the flat battery (A).
3. Connect the other end of the *red* jump lead to the positive terminal (+) in the vehicle providing assistance (B).
4. Connect one end of the *black* jump lead (C) to a suitable ground terminal, to a

## Jump start

### Jump leads

The jump lead must have a sufficient wire cross section.

- solid piece of metal in the engine block, or to the engine block itself.
- Connect the other end of the *black* jump lead  to a solid metal component bolted to the engine block or to the engine block itself of the vehicle with the flat battery. Do not connect it to a point near the battery.
  - Position the leads in such a way that they cannot come into contact with any moving parts in the engine compartment.

### Starting

- Start the engine of the vehicle with the boosting battery and let it run at idling speed.
- Start the engine of the vehicle with the flat battery and wait for 2 or 3 minutes until the engine is running.

### Removing the jump leads

- Before you remove the jump leads, switch off the dipped beam headlights if they are switched on.
- Turn on the heater blower and heated rear window in the vehicle with the flat battery. This helps minimise voltage peaks which are generated when the leads are disconnected.

- When the engine is running, disconnect the leads in reverse order to the details given above.

Make sure the battery clamps have sufficient metal-to-metal contact with the battery terminals.

If the engine fails to start after about 10 seconds, switch off the starter and try again after about 1 minute.

### WARNING

- Please note the safety warnings referring to working in the engine compartment >>> page 289.
- The battery providing assistance must have the same voltage as the flat battery (12V) and approximately the same capacity (see imprint on battery). Failure to comply could result in an explosion.
- Never use jump leads when one of the batteries is frozen. Danger of explosion! Even after the battery has thawed, battery acid could leak and cause chemical burns. If a battery freezes, it should be replaced.
- Keep sparks, flames and lighted cigarettes away from batteries, danger of explosion. Failure to comply could result in an explosion.
- Observe the instructions provided by the manufacturer of the jump leads.
- Do not connect the negative cable from the other vehicle directly to the negative

terminal of the flat battery. The gas emitted from the battery could be ignited by sparks. Danger of explosion.

- Never attach the negative cable to fuel system components or the brake lines in the other vehicle.
- The non-insulated parts of the battery clamps must not be allowed to touch. The jump lead attached to the positive battery terminal must not touch metal parts of the vehicle, this can cause a short circuit.
- Position the leads in such a way that they cannot come into contact with any moving parts in the engine compartment.
- Do not lean on the batteries. This could result in chemical burns.

### Note

The vehicles must not touch each other, otherwise electricity could flow as soon as the positive terminals are connected.

## Tow start and towing

### Introduction

**Tow-starting** means starting the engine of the vehicle while another pulls it.

**Towing** means one vehicle pulling another that is not roadworthy. »

Always consider the legal provisions relating to tow-starting and towing.

**For technical reasons, towing a vehicle with a discharged battery is not allowed. The jump start should be used instead** >>> page 50.

If the vehicle comes with the Keyless Access system, towing is only allowed with the ignition on!

The vehicle battery drains if the vehicle is towed with the engine switched off and the ignition connected. Depending on the battery charge status, the drop in voltage may be so large, even after just a few minutes, that no electrical device in the vehicle may work e.g. the hazard warning lights. In vehicles with the Keyless Access system, the steering wheel could lock >>> ⚠.

### ⚠ WARNING

A vehicle with no power should never be towed.

- During towing, never switch off the ignition using the start button. Otherwise, the electronic lock of the steering column could suddenly become blocked and it would be impossible to steer the vehicle. This could cause an accident, serious injury and loss of control of the vehicle.
- If during towing the vehicle runs out of power, stop towing immediately and re-

quest the assistance of specialist personnel.

### ⚠ WARNING

Vehicle handling and braking capacity change considerably during towing. Please observe the following instructions to minimise the risk of serious accidents and injury:

- As the driver of the vehicle being towed:
  - You should depress the brake much harder as the brake servo does not operate. Pay the utmost attention to avoid crashing into the towing vehicle.
  - More strength is required at the steering wheel as the power steering does not operate when the engine is switched off.
- As the driver of the towing vehicle:
  - Accelerate with particular care and caution.
  - Avoid sudden braking and manoeuvres.
  - Brake earlier than usual and more smoothly.

### ⚠ CAUTION

- To avoid damaging the vehicle, for example the paint, remove and replace the lid and towing eye carefully.
- Unburnt fuel could enter the catalytic converter and damage it during towing.

## Instructions for tow-starting

Vehicle's should not generally be tow-started. The jump start should be used instead >>> page 50.

For technical reasons, towing the following vehicles is **not** allowed:

- Vehicles with an automatic gearbox.
- If the vehicle battery is discharged, because in vehicles with the Keyless Access locking and ignition system the steering remains locked and the electronic parking brake cannot be deactivated nor can the electronic lock of the steering column be released if they are activated.
- If the battery is flat, it is possible that the engine control units may not operate correctly.

### ⚠ CAUTION

When tow-starting, unburnt fuel could enter the catalytic converter and damage it.

### i Note

The vehicle can only be jump-started if the electronic parking brake and, if appropriate, the electronic lock of the steering column are deactivated. If the vehicle has no power supply or there is an electric system fault, the engine must be jump-started to

deactivate the electronic parking brake and the electronic lock of the steering column.

## Towing instructions

Towing requires some expertise and experience, especially when using a tow rope. Both drivers should be familiar with the difficulties involved in towing. For this reason, inexperienced drivers should abstain from towing.

During towing, it should be ensured that no impermissible tractive forces or shocks are generated. When towing on an unpaved road, there is always a risk of overloading and damaging the anchorage points.

During towing, the towing vehicle can signal the change of direction even with the hazard warning lights turned on. To do so, at the same time, the turn signal lever must be operated with ignition switched on. Meanwhile, the hazard warning lights will go off. When the turn signal lever is returned to the rest position, the hazard warning lights will be automatically reactivated.

### Notes for the driver of the towed vehicle

- Leave the ignition on, so that the steering is not blocked, and the electronic parking brake may be deactivated and the turn signals and wash/wipe operated.

- More strength is required at the steering wheel as the power steering does not operate when the engine is switched off.
- You should depress the brake much harder as the brake servo does not operate. Avoid hitting the towing vehicle.
- Bear in mind the information and instructions in the manual of the vehicle to be towed.

### Notes for the driver of the towing vehicle

- Accelerate with particular care and caution. Avoid sharp manoeuvres.
- Brake earlier than usual and smoothly.
- Bear in mind the information and instructions in the manual of the towed vehicle.

### Tow rope or tow bar

It is safer for the vehicle to be towed using a tow bar, avoiding damage to the vehicle. A tow rope should only be used if a tow bar is not available.

A tow rope should be slightly elastic to avoid damage to both vehicles. It is advisable to use a tow rope made of synthetic fibre or similarly elastic material.

Only attach the tow rope or the tow bar to the towing eyes provided or a towing bracket.

If the vehicle has a **factory-fitted towing device**, towing with a tow bar is **only permitted**

if it has been specially designed to be installed on a tow hitch»» page 274 .

### When the vehicle has to be towed:

Check whether the vehicle may be towed »» page 54, Cases where towing the vehicle is not permitted.

The vehicle can be towed using a tow bar or tow rope in the normal way, with all four wheels on the road; it can also be towed with either the front or rear wheels lifted off the road.

- Switch the ignition on.
- Move the selector lever to the **N** »» page 201 position.
- Do not allow the vehicle to be towed at speeds of over 50 km/h (30 mph).
- The vehicle must not be towed further than 50 km (30 miles).
- If a breakdown lorry is used, vehicles with automatic transmission are only allowed to be towed with the front wheels suspended.

### Towing vehicles with four-wheel drive (4Drive)

Four-wheel drive vehicles (4Drive) can be towed using a tow bar or tow rope. If the vehicle is towed with the front or rear axle suspended, the engine must be switched off, otherwise the transmission may be damaged.

### Cases where towing the vehicle is not permitted

- If, due to a fault, the gearbox is out of lubricant.
- If the vehicle battery is discharged, because the steering remains locked and, if appropriate, the electronic parking brake cannot be deactivated or the electronic lock of the steering column released.
- If a distance above 50 km needs to be travelled.
- When, for example, after an accident, the smooth rotation of the wheels or the steering operation cannot be guaranteed.

### When the vehicle is to tow another vehicle:

- Observe legal requirements.
- Keep in mind the instructions in the manual on towing vehicles.

#### ⚠ CAUTION

If there is no oil in the gearbox or no lubricant in the automatic transmission the car may only be towed with the driven wheels lifted clear of the road, or transported on a special car transporter or trailer.

#### i Note

The vehicle can only be towed if the electronic parking brake and the electronic

lock of the steering column are deactivated. If the vehicle has no power supply or there is an electric system fault, the engine must be jump-started»» page 50 to deactivate the electronic parking brake and the electronic lock of the steering column.

### Front towline anchorage



**Fig. 41** On the right side of the front bumper: remove the cover.



**Fig. 42** On the right side of the front bumper: towline anchorage in position.

The housing of the screw towing eye is on the right side of the front bumper behind a lid»» **Fig. 41**.

The towing eye should always be kept in the vehicle.

Bear in mind the instructions for towing »» page 53.

### Fitting the towline anchorage

- Remove the towing eye from the vehicle tool kit in the luggage compartment »» page 41.
- Remove the cover by pressing down on its base and leave it hanging from the vehicle »» **Fig. 41**.
- Screw the towing eye in the housing by turning it as far as it will go **anticlockwise**»» **Fig. 42** »» ⚠. Use a suitable object



that can completely and securely tighten the towing eye in its housing.

- After towing, unscrew the towing eye **clockwise** with a suitable object.
- Replace the cover and press until the tab catches onto the bumper.
- Clean the towing eye if necessary and then store it in the luggage compartment along with the other vehicle tools.

#### ⓘ CAUTION

The towing eye must always be completely and firmly tightened. Otherwise, it could be released while towing and tow-starting.

### Rear towline anchorage

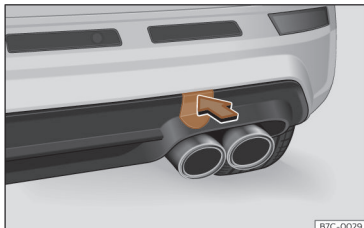

**Fig. 43** On the right side of the rear bumper: remove the cover.

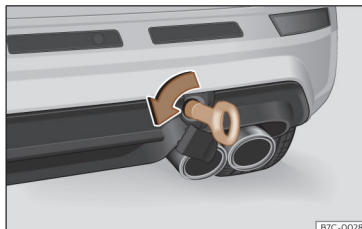

**Fig. 44** On the right side of the rear bumper: towline anchorage in position.

The housing of the screw towing eye is on the right side of the rear bumper behind a lid >>> **Fig. 43**.

Vehicles equipped as standard with a towing bracket **do not** have any housing for the screw towing eye behind the lid. In this case, the tow hitch needs to be extracted or installed and used for towing >>> page 274 , >>> ⓘ.

Bear in mind the instructions for towing >>> page 53.

#### Assemble the rear towing eye (cars without a factory-equipped towing bracket)

- Remove the towing eye from the vehicle tool kit in the luggage compartment >>> page 41.
- Press the upper side of the lid >>> **Fig. 43** to unclip it.

- Remove the lid and let it hang from the vehicle.

- Screw the towing eye in the housing by turning it to the maximum **anticlockwise** >>> **Fig. 44** >>> ⓘ. Use a suitable object that can completely and securely tighten the towing eye in its housing.

- After towing, unscrew the towing eye **clockwise** with a suitable object.

- Insert the upper flange of the lid into the opening of the bumper and press the lower side of the lid until it is inserted into the bumper.

- Clean the towing eye if necessary and then store it in the luggage compartment along with the other vehicle tools.

#### ⓘ CAUTION

- The towing eye must always be completely and firmly tightened. Otherwise, it could be released while towing and tow-starting.
- If the vehicle is factory-equipped with a towing bracket, it is only allowed to tow with a tow bar if this has been specially designed to be installed with a tow hitch. If an unsuitable tow bar is used, both the tow hitch and the vehicle may be damaged. Instead, a tow rope should be used.

## Fuses and bulbs

### Fuses

#### Introduction

In general, a fuse can be assigned to various electrical components. Likewise, an electrical component can be protected by several fuses.

Only replace fuses when the cause of the problem has been solved. If a newly inserted fuse blows after a short time, you must have the electrical system checked by a specialised workshop as soon as possible.

#### **⚠ WARNING**

The high voltages in the electrical system can give serious electrical shocks, causing burns and even death!

- Never touch the electrical wiring of the ignition system.
- Take care not to cause short circuits in the electrical system.

#### **⚠ WARNING**

Using unsuitable fuses, repairing fuses or bridging a current circuit without fuses can cause a fire and serious injury.

- Never use a fuse with a higher value. Only replace fuses with a fuse of the same am-

perage (same colour and markings) and size.

- Never replace a fuse by a metal strip, staple or similar.

#### **⚠ CAUTION**

- To prevent damage to the vehicle's electrical system, before replacing a fuse always turn off the ignition, the lights and all electrical elements.
- Protect the fuse boxes when open to prevent the entry of dust or humidity as they can damage the electrical system.

#### **i Note**

- One component may have more than one fuse.
- Several components may run on a single fuse.
- In the vehicle, there are more fuses than those indicated in this chapter.

### Fuses inside the vehicle



**Fig. 45** Left hand drive vehicles: fuse box cover under the driver's side dashboard

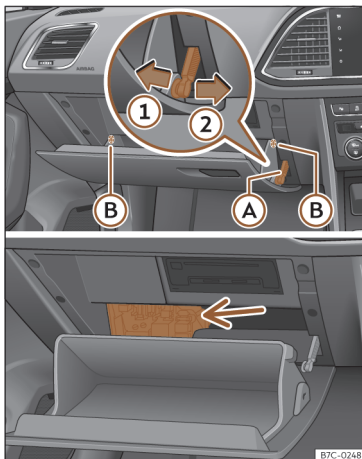

**Fig. 46** Glove box (right hand drive): fuse box access.

### Opening and closing the fuse box situated below the dash panel (left-hand drive)

- *Open*: fold the cover down >>> **Fig. 45**.
- *Close*: push back the cover in until it clicks into place.

### Fuses behind the glove compartment (right-hand steering wheel)

- Open the glove compartment and, if necessary, empty it.

- Undo the opening limiter >>> **Fig. 46** (A) in two steps: first, unlock the limiter by pulling back on it (arrow ①) and then move it gently to the right (arrow ②). Remove the guide when the cover is in the normal opening position (30°).
- Free the side pivots (B) to release the cover to its second opening position (60°).
- Follow the same procedure in reverse order to return the glove compartment to its normal position.

### Identifying fuses below the dashboard by colours

Colour	Amp rating
Light brown	5
Brown	7.5
Red	10
Blue	15
Yellow	20
White or transparent	25
Green	30
Orange	40

### ⚠ CAUTION

- Always carefully remove the fuse box covers and refit them correctly to avoid problems with your vehicle.

- Protect the fuse boxes when open to avoid the entry of dust or humidity. Dirt and humidity inside fuse boxes can cause damage to the electrical system.

### Fuses in the engine compartment

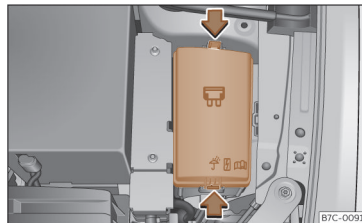
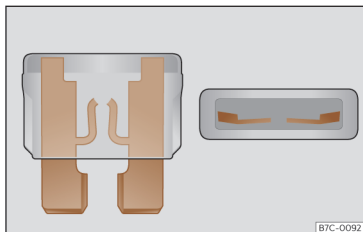

**Fig. 47** In the engine compartment: fuse box cover.

### To open the engine compartment fuse box

- Open the bonnet >>> page 289.
- Press the locking tabs to release the fuse box cover >>> **Fig. 47**.
- Then lift the cover out.
- To fit the cover, place it on the fuse box. Push the locking tabs down until they click audibly into place.

### Replace a blown fuse



**Fig. 48** Image of a blown fuse.

#### Preparations

- Switch off the ignition, lights and all electrical equipment.
- Open the corresponding fuse box  
»» page 56, »» page 57.

#### Recognise a blown fuse

A fuse is blown if its metal strip is ruptured  
»» **Fig. 48**.

- Point a lamp at the fuse to see if it has blown.

#### To replace a fuse

- Remove the fuse.
- Replace the blown fuse by one with an *identical* amperage rating (same colour and markings) and *identical* size.

- Replace the cover again or close the fuse box lid.

### Fuse placement

#### Fuses in the vehicle interior

No.	Consumers/Amps	
4	Alarm horn	7.5
5	Gateway	7.5
6	Automatic gearbox lever	7.5
7	Air conditioning and heating control panel, back window heating, auxiliary heating.	10
8	Diagnosis, electronic parking brake switch, light switch, reversing light, interior lighting, driving mode, lit-up door sill, rain sensor	7.5
9	Steering column	7.5
10	Radio display	7.5
11	Left lights	40
12	Radio	20
13	Driver and passenger seat belt pre-tensioner	25
14	Air conditioner fan	40
15	Steering column release	10
16	Connectivity Box	7.5

No.	Consumers/Amps	
17	Instrument panel, OCU	7.5
18	Rear camera and surroundings camera	7.5
19	Kessy	7.5
20	SCR, engine relay, 1.5	10/15
21	4x4 Haldex Control Unit	15
22	Trailer	15
23	Electric sunroof	30
24	Right lights	40
25	Left door	30
26	Heated seats	30
27	Interior light	30
28	Trailer	25
31	Rear lid control unit	30
32	Control unit for park distance control, front camera and radar	7.5/10
33	Airbag	7.5
34	Reverse switch, climate sensor, electrochromic mirror, rear power sockets (USB)	7.5
35	Diagnosis, headlight control unit, headlight adjuster	7.5
38	Trailer	25

## Fuses and bulbs

No.	Consumers/Amps	
39	Right door	30
40	12V socket	20
41	Driver and passenger seat belt pre-tensioner	25
42	Central locking	40
43	Beats Audio CAN and MOST.	40
44	Trailer	15
45	Electric driver's seat	15
46	USB socket	7.5
47	Rear window wiper	15
49	Starter motor; clutch sensor	7.5
52	Driving mode.	15
53	Heated rear window	30

### In-line fuse/Amps

230V rear power sockets	30
-------------------------	----

### Fuse arrangement in engine compartment

No.	Consumers/Amps	
1	ESP control unit	25
2	ESP control unit	40/60
3	Engine control unit	15
4	Engine sensors	10

No.	Consumers/Amps	
5	Engine sensors	10
6	Brake light sensor	7.5
7	Engine power supply	10
8	Lambda probe	10
10	Pump control unit for T3W Cupra	30
11	PTC	40
12	PTC	40
13	Gearbox pump	30
14	Heated windscreen	50
15	Horn	15
16	Petrol pump	20
17	Engine control unit	7.5
18	Terminal 30 (positive reference)	7.5
19	Front windscreen washer	30
21	Automatic gearbox control unit	15
22	Engine control unit	7.5
23	Starter motor	30
24	PTC	40
36	Left LED headlight	15
37	Parking heating	20
38	Right LED headlight	15

### Note

- In the vehicle, there are more fuses than those indicated in this chapter. These should only be changed by a specialised workshop.
- Positions not containing a fuse do not appear in the following tables.
- Some of the equipment listed in the tables below pertain only to certain versions of the model or are optional extras.
- Please note that the above lists, while correct at the time of printing, are subject to change.

## Changing bulbs

### Changing bulbs

#### Full-LED headlights

Full-LED headlights handle all light functions (daylight, side light, turn signal, dipped beam and route light) with light emitting diodes (LEDs) as a light source.

Full-LED headlights are designed to last the lifetime of the car and light bulbs cannot be replaced. In case of headlight failure, go to an authorised workshop to have it replaced. »

**Fog lights, rear lights, license plate light,  
side turn signals and additional brake light**

Taking into account that they use LED bulbs,  
they should be replaced at a technical service  
centre.



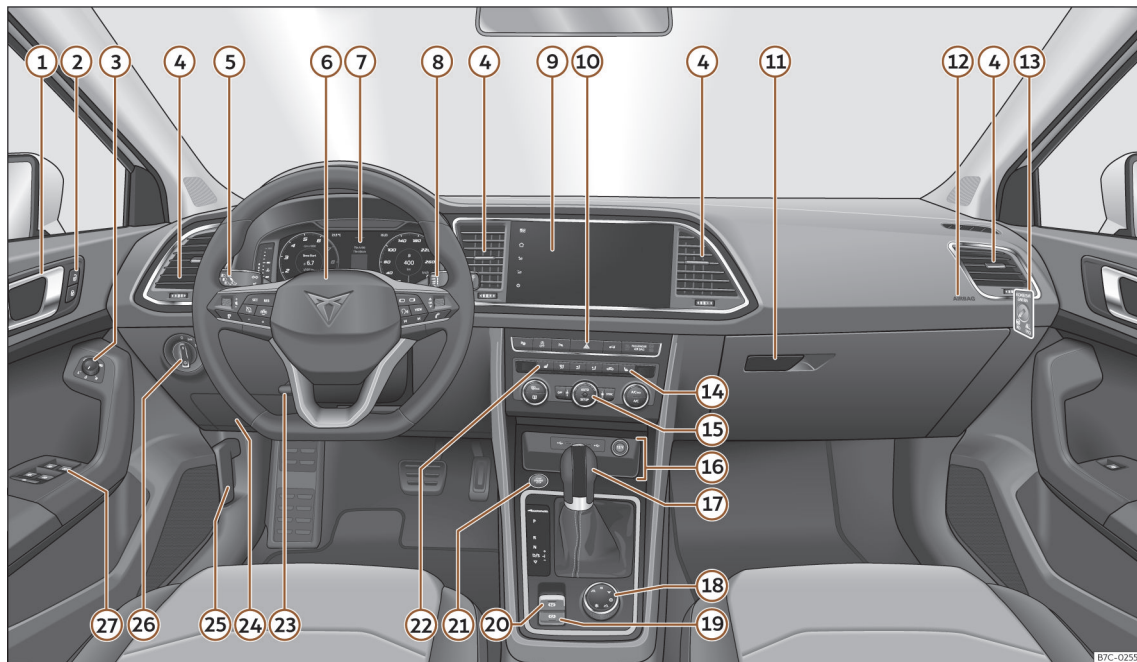

Fig. 49 Instruments and controls.

B7C-0255



# Operation

## Controls and displays

### Interior view

#### Overview

① Door handle			
② Central locking switch	93		
③ Control for the electric adjustment of the exterior mirrors	121		
④ Air vents	145		
⑤ Control lever for:			
– Turn signals and main beam headlights	113		
– Lane Assist	234		
– Main beam assist	114		
– Cruise control system (CCS)	220		
⑥ Steering wheel with horn and			
– Driver airbag	26		
– On-board computer controls	78		
– Controls for radio, telephone, navigation and speech dialogue system	172		
– Paddle levers for tiptronic gearshift (automatic gearbox)	203		
⑦ Instrument panel	64		
		⑧ Control lever for:	
		– Windscreen wipers and washer	118
		– Wipe and wash system	118
		– On-board computer	69
		⑨ Infotainment system	172
		⑩ Depending on the equipment, buttons for:	
		– Start-Stop system	199
		– Park assist system	259
		– Hazard warning lights	116
		– Tyre pressure switch	310
		– Airbag off display	27
		⑪ Glove compartment	139
		⑫ Front passenger airbag	26
		⑬ Front passenger airbag switch	27
		⑭ Front passenger seat heating control	147
		⑮ Automatic air conditioning controls	144
		⑯ Depending on the equipment:	
		– USB port	193
		– Lighter/power socket	140
		– Connectivity Box/Wireless Charger	192
		– Storage compartment	138
		⑰ DSG automatic gearbox lever	201
		⑱ Rotating control (Driving Experience button) for driving profiles	210
		⑲ Auto Hold switch	248
		⑳ Electronic parking brake switch	245
		㉑ Start-up push button (Keyless Access closing and start-up system)	195
		㉒ Driver's seat heating control	147
		㉓ Steering column adjustment lever	15
		㉔ Knee airbag	28
		㉕ Bonnet lock release	290
		㉖ Headlight switch	111
		㉗ Electric windows	106

#### Note

- Some of the equipment listed in this section is only fitted on certain models or are optional extras.
- The arrangement of controls on right-hand drive models may be slightly different from the layout shown in»» page 62. However, the symbols used to identify the controls are the same.

## Instruments and warning/control lamps

### Instrument panel

#### Introduction

After switching the engine on with a 12-volt battery that is heavily discharged or newly changed some system settings (such as the time, the date, the personalised comfort settings and the programming) might be altered or deleted. Check and correct these settings once the battery is sufficiently charged.

#### WARNING

Any distraction may lead to an accident, with the risk of injury.

- Do not operate the instrument panel controls when driving.
- To reduce the risk of accident and injury, only make adjustments to the instructions on the screen of the instrument panel and to the instructions on the screen of the Infotainment system when the vehicle is stationary.

## Digital instrument panel (Digital Cockpit)

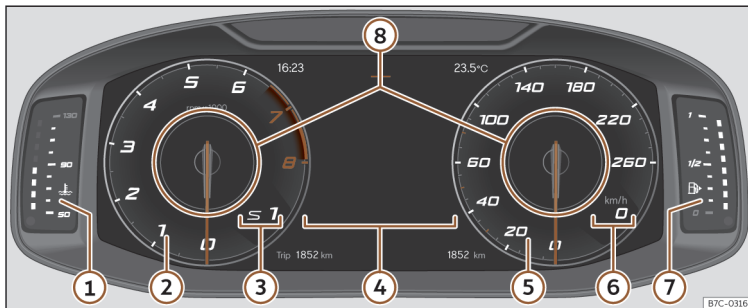

Fig. 50 Digital Cockpit on the instrument panel (classic view).

Details of the instruments:

- ① **Engine coolant temperature display**  
»» page 76
- ② **Revolution counter.** Revolutions per minute the engine is running»» page 75 .
- ③ **Gear engaged or position of the selector lever currently selected**
- ④ **Screen display**»» page 66
- ⑤ **Speedometer**
- ⑥ **Digital speed display**
- ⑦ **Fuel gauge**»» page 75 .
- ⑧ **Information Profile**»» page 65 .

The Digital Cockpit is a digital instrument panel with a high-resolution TFT colour screen. It has a 4 views accessible using the

button **VIEW** of the multifunction steering wheel. By selecting different information profiles, indications other than the classic circular instruments can be displayed, such as navigation data, multimedia information or travel data.

The 4 views are:

- Classic
- Dynamic
- Navigation
- Sport

All views will display information on the screen about audio, phone, travel data, vehicle status, navigation and driving aids.

In all views the information displayed in **Information profiles** can be customised  
»» Fig. 50 ⑧.

### Information profiles

The **INSTRUMENT CLUSTER** option (Infotainment button > **View** > **Instrument cluster**) can be used to choose between the different options for viewing information to be displayed in the Digital Cockpit.

### Classic View

The revolutions per minute and speedometer needles appear along the entire length  
»» Fig. 50.

»

### View 1, 2, 3 or AUTOMATIC<sup>1)</sup>

Personalisation of the information that appears in the Digital Cockpit. Only 2 of these items of information can be displayed at the same time, but the user chooses which to display, and in what order, by moving the finger vertically over the dials.

Depending on the version, the Views can be memorised by exiting the menu or keeping the **View** button pressed.

- **Consumption.** Graphic representation of the current consumption and digital display of the average consumption.
- **Audio.** Digital display of the current audio playback.
- **Altitude.** Digital display of the current altitude above sea level.
- **Compass.** Digital display of the compass.
- **Information about the final destination.** Digital display of the remaining travelling time, distance to the destination and the estimated time of arrival.
- **Operating range.** Digital display of the remaining range.
- **Travel time.**
- **Route guidance.**

- **Journey.** Digital display of the distance travelled.
- **Assist systems.** Graphic representation of different assistance systems.
- **Traffic signs.** Display of traffic signs detected.
- **Navigation.** Graphical representation of the navigation with arrows.

It may vary based on the features, the number and the contents of the selectable information profiles.

### Navigation map in the Digital Cockpit

Depending on the features, the Digital Cockpit can display a detailed map. To do this, select the **Navigation** option in the menu on the instrument panel»» page 68.

Depending on the equipment, the navigation map can be displayed in the Digital Cockpit or on the Infotainment system or on both at the same time. If it is displayed only on the infotainment system, the Digital Cockpit will only display the direction arrows.

### Transfer of navigation map

Using the map transfer key, the map is transferred from the infotainment system to the Digital Cockpit and vice versa.

Using the right thumbwheel of the multifunction steering wheel, from the **Navigation** menu, you can transfer the map back to the infotainment system.

### Status display

#### Possible indications on the instrument panel display

Different pieces of information can be displayed on the screen of the instrument panel, depending on the features of the vehicle.

- Doors, bonnet and rear lid open
- Warning and information messages
- Odometer
- Time»» page 75
- Indications of the radio and navigation system
- Indications of the phone
- Outside temperature
- Indications of the compass

<sup>1)</sup> Pre-set information depending on the selected "Driving mode".

- Selector lever positions
- Gear recommendation (Triptonic mode) >>> page 208
- Display of travel data (multifunction display) and menus for different settings >>> page 68
- Service interval display >>> page 77
- Speed warning >>> page 69
- Speed warning for winter tyres
- Start-Stop system status display >>> page 199
- Signs detected by the traffic signal detection system >>> page 72
- Driver assistance system display >>> page 216
- Copyright

### Doors, bonnet and rear lid open

When the vehicle is unlocked and while driving, the instrument panel display shows if any of the doors, the bonnet or rear lid are opened and, in some cases, it is also indicated by an audible warning. The display may vary according to the type of instrument panel fitted.

### Selector lever positions (DSG® dual clutch gearbox)

The current position of the selector lever is shown on the side of the lever and on the instrument panel display. When the lever is in

the **D/S** position or in the Tiptronic position, in some cases, the gear engaged in each case is shown on the instrument panel display.

### Outside temperature indicator

If the outside temperature is lower than approximately +4 °C (+39 °F), the “ice crystal symbol” ❄ on the outside temperature display also lights up. This symbol remains lit until the outside temperature exceeds +6 °C (+43 °F) >>> .

When the vehicle is stationary, when the auxiliary heater is switched on or when driving at very low speeds, the outside temperature indicated may be higher than the actual temperature due to the heat produced by the engine.

The margin of measurement ranges from -45 °C (-49 °F) to +76 °C (+169 °F).

### Gear-change recommendation

While driving, the instrument panel of certain vehicles may indicate a gear recommendation for saving fuel >>> page 208.

### Odometer

The *odometer* registers the total distance travelled by the car.

The *partial odometer (trip)* shows the distance travelled since the last time it was reset to zero.

- Set the odometer to zero via the Infotainment system or the multifunction steering wheel >>> page 69.

### Speed warning for winter tyres

If the maximum set speed is exceeded, this is displayed on the instrument cluster display >>> page 68.

The speed warning can be set in the infotainment system using the infotainment button  > **Settings** > **Tyres** >>> page 86.

### Indications of the compass

Depending on the equipment, when the ignition is on, the instrument panel display indicates the direction in which you are driving with a symbol, e.g. NW for Northwest.

When the Infotainment system is on and there is no route guidance active, the graphic representation of a compass is also shown.

### Copyright

Legal text about the property rights and copyrights of the instrument cluster.

»

**⚠ WARNING**

Even when the outside temperature is higher than freezing temperature, some roads and bridges could be frozen.

- The “ice crystal symbol” indicates that there may be a risk of freezing.
- At outside temperatures above +4 °C (+39 °F), there may be ice even when the “ice crystal symbol” is not on.
- The outside temperature sensor takes a guideline measurement.

**i Note**

- There are different instrument panels and therefore the versions and instructions on the display may vary. In the case of displays without warning or information texts, faults are indicated exclusively by the control warning lamps.
- Some indications on the instrument panel screen may be concealed by a sudden event, e.g. an incoming call.
- Depending on the equipment, some settings and instructions can be carried out or displayed on the infotainment system as well.
- If there are several warnings at the same time, the symbols will be displayed one after the other for a few seconds. The symbols will stay on until you remove the cause.
- If when switching on the ignition warnings are shown about existing faults, it

might not be possible to change the settings or show the information as described. In this case, go to a specialised workshop and request a repair.

**Instrument panel menus**

The number of menus and information items available will depend on the vehicle's electronics and features.

A specialised workshop can programme or modify additional functions, according to the vehicle equipment. To do so, CUPRA recommends going to a specialised CUPRA dealer or any SEAT dealership.

Some menu options can only be read when the vehicle is stationary.

- **Driving data**»»» page 69
- **Assist systems.**
  - Front Assist On/Off»»» page 223
  - ACC (only display)»»» page 226
  - Lane Assist On/Off»»» page 234
  - Side Assist On/Off»»» page 240
- **Navigation.**
- **Audio.**
- **Telephone.**
- **Vehicle status**»»» page 70

**Service Menu**

In the Service menu various settings can be adjusted depending on the features.

**Open the Service menu**

To open up the **Service** menu, select the **Range** information profile while in the **Driving data** menu, and keep the **OK** key pressed on the multifunction steering wheel for approximately 4 seconds. When it is released, the **Service** menu will be displayed. Now you can browse through the menu using the keys on the multifunction steering wheel as usual.

**Restart the service interval display**

Select the **Service** menu and follow the instructions on the screen of the instrument panel.

**Restart the oil service**

Select the **Restore Oil service** menu and follow the instructions on the instrument panel display.

**Reset driving data**

Select the **Reset trip** menu and follow the instructions on the instrument panel display to reset the value.

### Identifying letters on engine (LDM)

Select the menu **Engine code**. The identifying letters of the engine will be shown on the instrument cluster display at the bottom left.

### Setting the clock

Select the **Time** menu and set the correct time by turning the right thumbwheel of the multifunction steering wheel.

### Driving data indicator (multifunction display)

The display of the travel data (multifunction display) shows different values about the journey and the consumption.

#### Change from one display to another

- Turn the right thumbwheel of the multifunction steering wheel»» page 78.

#### Changing memory

While in **Travel data > General information** press **OK** on the multi-function steering wheel to switch between the 3 memories<sup>1)</sup>:

- **Since start:** The memory is deleted if the journey is interrupted for more than 2 hours.
- **Since refuelling:** Display and storage of the journey data and the consumption values collected. When refuelling, the memory is deleted.
- **Long-term:** This memory contains travel data up to a maximum of 19 hours and 59 minutes or 99 hours and 59 minutes, or up to a maximum of 1999.9 km or 9999.9 km. When one of these values is exceeded (varies depending on the version of the instrument panel), the memory is deleted.
- **Current consumption:** The current fuel consumption display operates throughout the journey, in litres/100 km; and with the engine running and the vehicle stopped, in litres/hour.
- **Average consumption:** The average fuel consumption is displayed after driving for approximately 300 metres.
- **Travelling time:** This indicates the hours (h) and minutes (min) since the ignition was switched on.
- **Range:** Approximate distance in km that can still be travelled if the same driving style is maintained.
- **Distance:** Distance covered in km (m) after switching on the ignition.
- **Average speed:** The average speed will be shown after driving for approximately 100 metres.
- **Digital speed:** Current speed displayed in digital format.
- **Eco tips:** Recommendations messages are shown to reduce consumption through good driving practices, e.g. **Air conditioning on: close the window.** »

#### Delete journey data presets

- Select the memory that you wish to erase.
- Keep the **OK** button on the multi-function steering wheel pressed for approximately 2 seconds.

#### Select the instructions

In the Infotainment system, in the menu **Vehicle settings**, you can display different travel data»» page 86.

<sup>1)</sup> This will show all data on the display at the same time: distance travelled, average consumption, average speed and autonomy.

- **Boost/Torque:** Indicates the power and torque of the combustion engine (does not indicate electric mode).
- **FAS:** Reduced assistant indication.



### Setting a speed warning

- Select the display **Warning at --- km/h** or **Speed warning at --- mph**.
- Press the **OK** button on the multi-function steering wheel to memorise the current speed and activate the warning.
- **Activate:** set the desired speed within 5 seconds by rotating the wheel on the multi-function steering wheel. Next, press the **OK** button again or wait several seconds. The speed is stored and the warning activated.
- **Deactivate:** press the **OK** button. The stored speed is deleted.

The warning can be adjusted for speeds between 30 km/h (18 mph) and 250 km/h (155 mph).

### Display Oil temperature

The engine reaches its operating temperature when, under normal driving conditions, the oil temperature is between **80°C** (176°F) and **120°C** (248°F). If a great effort is required from the engine and the outside temperature is high, the engine oil temperature may increase. This does not present any problem

as long as the warning lamps  or  >>> page 293 do not appear on the display.

### Warning and information messages (Vehicle status)

The system runs a check on certain components and functions when the ignition is switched on and while the vehicle is moving. Faults are displayed on the instrument cluster display as red and yellow warning symbols accompanied with messages and, as applicable, even an audible signal >>> page 80 . The representation of the messages and symbols may vary depending on the version of the instrument panel.

Existing faults can also be checked manually. To do so, open the menu **Vehicle status** or **Vehicle** >>> page 68 .

#### Priority 1 warning (red)

The symbol lights up or flashes (in part accompanied by audible warnings).  **Stop driving!** Danger! Check the fault and eliminate the cause. If necessary, seek professional assistance.

#### Priority 2 warning (yellow)

The symbol lights up or flashes (in part accompanied by audible warnings). Operating faults or the lack of operating fluids can

cause damage to the vehicle or a fault. Check the faulty function as soon as possible. If necessary, seek professional assistance.

#### Information message

It provides information about processes in the vehicle.

### Driver alert system (break recommendation)



**Fig. 51** On the instrument panel display: driver alert system symbol.

The Fatigue detection informs the driver when their driving behaviour shows signs of fatigue.

#### Function and operation

Fatigue detection determines the driving behaviour of the driver when starting a journey,



making a calculation of tiredness. This is constantly compared with the current driving behaviour. If the system detects that the driver is tired, an audible warning is given with a sound and an optic warning is shown with a symbol and complementary message on the instrument panel display»» Fig. 51. The message on the instrument panel display is shown for approximately 5 seconds, and depending on the case, is repeated. The system stores the last message displayed.

The message on the instrument panel display can be switched off by pressing the **OK** button on the multi-function steering wheel»» page 78.

The message can be recalled to the instrument panel display using the multifunction display»» page 69.

### Conditions of operation

Driving behaviour is only calculated on speeds above about 65 km/h (40 mph) up to around 200 km/h (125 mph).

### Switching on and off

Fatigue detection can be activated or deactivated in the infotainment system using the function button  > **Driver assistance > Fatigue detector**»» page 86. A mark indi-

cates that the adjustment has been activated.

### System limitations

The Fatigue detection has certain limitations inherent to the system. The following conditions can limit the Fatigue detection or prevent it from functioning.

- At speeds below 65 km/h (40 mph)
- At speeds above 200 km/h (125 mph)
- When cornering
- On roads in poor condition
- In unfavourable weather conditions
- When a sporty driving style is employed
- In the event of a serious distraction to the driver

Fatigue detection will be restored when the vehicle is stopped for more than 15 minutes, when the ignition is switched off or when the driver has unbuckled their seat belt and opened the door.

In the event of slow driving during a long period of time (below 65 km/h, 40 mph) the system automatically re-establishes the tiredness calculation. When driving at a faster speed the driving behaviour will be recalculated.

### WARNING

Do not let the comfort afforded by the Fatigue detection system tempt you into taking any risks when driving. Take regular breaks, sufficient in length when making long journeys.

- The driver always assumes the responsibility of driving to their full capacity.
- Never drive if you are tired.
- The system does not detect the tiredness of the driver in all circumstances. Consult the information in the section»» page 71, System limitations.
- In some situations, the system may incorrectly interpret an intended driving manoeuvre as driver tiredness.
- No warning is given in the event of the effect called microsleep!
- Please observe the indications on the instrument panel and act as is necessary.

### Note

- Fatigue detection has been developed for driving on motorways and well paved roads only.
- If there is a fault in the system, have it checked by a specialised workshop.

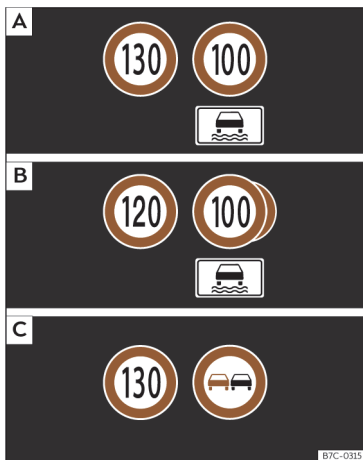
Road sign detection system<sup>1)</sup>

**Fig. 52** On the instrument panel display: examples of speed limits or overtaking prohibitions with their respective additional signs.

The traffic sign detection system records the standard traffic signs in front of the vehicle with a camera located on the base of the in-

terior mirror and provides information about speed limits and overtaking prohibitions.

Within its limitations, the system also displays additional signals, such as time-specific prohibitions, signs for vehicles towing trailers >>> page 274 or limitations that only apply in the event of rain. Even on journeys without signs, the system may display any applicable speed limits.

The traffic sign detection system does not work in all countries. Keep this in mind when travelling abroad.

**Shown on the display**

The traffic signs detected by the system are displayed on the dash panel display >>> Fig. 52 and, depending on the navigation system fitted in the vehicle, on the infotainment system as well >>> page 82.

If the road sign view is not selected in the information profiles >>> page 65, the maximum speed limit will be displayed in a reduced view.

In Germany, on motorways and vehicle roads, besides speed limits and overtaking prohibitions the system also displays the end of prohibition signs. The valid speed limit at the time in other countries is always shown.

**Road sign detection system messages:****There are no traffic signs available**

- The system is in its start-up phase.
- **OR:** the camera has not recognized any mandatory or prohibitive sign.

**Error: Dynamic Road Sign Display**

- There is a fault in the system. Have the system checked by a specialised workshop.

**Speed warning currently unavailable**

- The speed warning function of the road sign detection system is faulty. Have the system checked by a specialised workshop.

**Dynamic Road Sign Display: please clean the windscreen.**

- The windscreen is dirty in the camera area. Clean the windscreen.

**Dynamic Road Sign Display currently restricted.**

- The navigation system is not transmitting data. Check if the navigation system has updated maps.
- **OR:** the vehicle is in a region not included on the navigation system's map.

<sup>1)</sup> System available depending on the country.

### No data available

- The traffic sign detection system does not work in the current country.

### Activate and deactivate the road sign display on the instrument panel

The permanent road sign view on the instrument cluster can be switched on or off in the infotainment system using the button  >

#### Driver assistance.

### Display of traffic signs

When the traffic sign detection system is connected, a camera located on the base of the interior rear-view mirror records the traffic signs in front of the vehicle. After checking and evaluating the information from the camera, the navigation system and the current vehicle data, up to three valid road signs are displayed >>> **Fig. 52 B.**

**First:** The sign that is currently valid for the driver is shown in the left side of the screen. For example, a maximum speed limit of **130 km/h (100 mph)** >>> **Fig. 52 A.**

**Second:** A sign valid only in certain circumstances, e.g. **100 km/h (60 mph)** is shown second, together with the additional rain sign.

**Additional sign:** The supplementary panel will display the circumstances (rain, times of day, fog, etc.) under which the displayed speed limit is in force.

**Third:** Thirdly, a sign prohibiting overtaking is partially displayed. If there is no conditional speed limit and overtaking is prohibited, the latter sign will be displayed in second place >>> **Fig. 52 C.**

### Speed warning

If the system detects that the permitted speed is exceeded, it may warn the driver with a “gong” and visually with a message on the dash panel display.

The speed warning can be set or completely switched off in the infotainment system using the button  > **Driver assistance** >>> **page 82.** The speed is adjusted in steps of 5 km/h (3 mph) within a range of between 0 km/h (mph) and 10 km/h (6 mph) above the maximum speed permitted.

### Trailer mode

In vehicles equipped with a towing bracket device from the factory and a trailer that is electrically connected to the vehicle, it is possible to activate or deactivate the display of specific traffic signs for vehicles with trailer, such as speed limits or overtaking prohibitions. It can be activated or deactivated in the infotainment system using the button  > **Driver assistance** > **Trailer assist** >>> **page 82.**

For trailer mode, the display of speed limits applicable to the type of trailer or to the legal

provisions can be adjusted. The speed is adjusted in steps of 10 km/h (5 mph) within a range of between 60 km/h (40 mph) and 130 km/h (80 mph). If it is adjusted to a speed greater than that which is permitted in the country in question for driving with a trailer, the system automatically displays the usual speed limits, e.g. in Germany 80 km/h (50 mph).

If the speed warning for the trailer is deactivated, the system displays the speed limits as if there were no trailer hitched.

### Limited operation

The traffic sign detection system has certain limitations. The following cases may lead the system to operate with limitations or not at all:

- In the case of poor visibility, e.g. in snow, rain, fog or intense mist.
- In cases of dazzling, e.g. caused by head-on traffic or by the sun.
- When driving at high speeds.
- If the camera is covered or dirty.
- If the traffic signs are out of the camera's field of vision.
- If the traffic signs are partially or totally covered, e.g. by trees, snow, dirt or other vehicles.
- In the case of traffic signs that do not fulfil the regulations.

- In the case of damaged or bent traffic signs.
- In the case of variable messages on overhead or gantry signs (LED-based variable traffic signs or other lighting units).
- If the maps on the navigation system are not up-to-date.
- In the case of adhesives affixed to vehicles that depict traffic signs, e.g. speed limits on lorries.

### ⚠ WARNING

The technology in the traffic sign detection system cannot change the limits imposed by the laws of physics and only works within the system's limits. Do not let the extra convenience afforded by the traffic sign detection system tempt you into taking any risks when driving. The system is not a replacement for driver awareness.

- Adapt your speed and driving style to suit visibility, weather, road and traffic conditions.
- Poor visibility, darkness, snow, rain and fog may lead to the system failing to display traffic signs or not displaying them correctly.
- If the camera's field of vision is dirty, covered or damaged, system operation may be impaired.

### ⚠ WARNING

The driving recommendations and traffic indications shown on the traffic sign detection system may differ from the actual current traffic situation.

- The system may not detect or correctly show all the traffic signs.
- Traffic signs and traffic regulations have priority over the recommendations and displays provided by the system.

### ⚠ WARNING

If messages are ignored, the vehicle may stall in traffic and cause accidents and severe injuries.

- Never ignore the messages displayed.
- Stop the vehicle at the next opportunity and in a safe place.

### i Note

To avoid affecting the correct operation of the system, take the following points into consideration:

- Regularly clean the area of vision of the camera and keep it in a clean state, without snow or ice.
- Do not cover the field of vision of the camera.
- Always replace damaged or worn blades when required to avoid lines on the camera's field of vision.

- Check that the windscreen is not damaged in the area of the camera's field of vision.
- The use of outdated maps on the navigation system may cause the system to show traffic signs incorrectly.
- In the waypoints mode of the navigation system, the traffic sign detection system is only partly available.
- Failure to heed the control lamps and corresponding text messages when they light up may result in damage to the vehicle.

## Eco-efficient driving assistance



**Fig. 53** Eco-efficient driving assistance indication (schematic representation).

Eco-efficient driving assistance helps you drive with care and with low energy consumption by following instructions

superimposed in the digital cockpit, depending on the situation.

When you approach places such as a junction, a roundabout or a section of road with a speed limit, the symbol  is displayed along with an event in the digital cockpit»» Fig. 53.

### WARNING

The system is not a replacement for driver awareness.

- Adapt your speed and driving style at all times to suit visibility, weather, road and traffic conditions.
- Traffic signs on the road and traffic regulations have priority over eco-driving notes.

### Note

- The appearance of the symbols may vary slightly depending on the equipment and model. System updates may modify or expand the symbols.
- When the system is switched on, eco-efficient driving assistance can also increase recuperation without any indication being displayed. This can occur in situations such as when the accelerator pedal is released when a vehicle is driving in front. In this case, energy recuperation is adapted match the speed of the vehicle in front without any indication being displayed.

## Time

### Setting the time on the infotainment system

- Press the infotainment  button.
- Press the function button **Settings** > **Time and date** to set the time»» page 82.

## Revolution counter

The rev counter indicates the number of engine revolutions per minute.

Together with the gear-change indicator, the rev counter offers you the possibility of using the engine of your vehicle at a suitable speed.

The beginning of the red zone of the rev counter indicates the maximum speed in any gear after running-in and with the engine hot. However, it is advisable to move the selector lever to **D** or lift your foot off the accelerator before the needle reaches the red zone »» .

We recommend that you avoid high revs and that you follow the recommendations on the gear-change indicator. Consult the additional information in»» page 208, Selecting the optimal gear.

### CAUTION

- To prevent damage to the engine, the rev counter needle should only remain in the red zone for a short period of time.
- When the engine is cold, avoid high revs and heavy acceleration and do not make the engine work hard.

### For the sake of the environment

Changing up a gear early will help you to save fuel and minimise emissions and engine noise.

## Fuel gauge



Fig. 54 Fuel gauge.

## Control lamps



It lights up, and in addition, the low-er diode lights up in red

Fuel tank almost empty. The fuel reserve level has been reached >>> ⚠. Refuel as soon as you have the opportunity.  
When the fuel level is very low, the lower diode flashes red.

The display only works when the ignition is switched on.

The fuel range is displayed on the instrument panel.

You can consult the tank capacity of your vehicle in the >>> page 331 section.

### ⚠ WARNING

When driving with low fuel, the vehicle may stall in traffic and cause accidents and severe injuries.

- If the fuel tank level is too low, fuel could reach the engine irregularly, particularly when driving up or down slopes.
- The steering system and the driver assistance systems and brakes do not work when the engine is running irregularly or switches off due to lack of fuel or an irregular supply thereof.
- Always refuel when there is only one quarter of fuel in tank to prevent the vehicle to stop due to lack of fuel.

### ⚠ CAUTION

Never run the fuel tank completely dry. An irregular fuel supply can cause misfiring and unburnt fuel could enter the exhaust system. The catalytic converter or the particulate filter may get damaged!

### i Note

The small arrow on the fuel gauge next to the fuel pump symbol points out towards the side of the vehicle with the fuel tank flap.

## Engine coolant temperature indicator.



Fig. 55 Engine coolant temperature indicator.

>>> Fig. 55:

- Ⓐ **Cool zone.** The engine has not reached operating temperature yet. Avoid high engine speeds and stressing the engine if it has not reached operating temperature.
- Ⓑ **Normal zone.** At high outside temperatures and when making the engine work hard, the diodes may continue lighting up and reach the upper zone. This is no cause for concern, provided the control lamp does not light up ⚠.
- Ⓒ **Warning area.** When the engine is working hard, especially at high outside temperatures, the diodes may light up in the warning area.

The coolant temperature gauge only works when the ignition is switched on.

## Control and warning lamp

It lights up red

⚠ Do not carry on driving!  
Engine coolant level too low, coolant temperature too high.

Flashes red

Fault in the engine coolant system.

- Stop the vehicle, switch off the engine and let it cool down.
- Check the engine coolant level >>> page 295.

- If the warning lamp does not switch off even if the coolant level is correct, request assistance from specialised personnel.

### ⓘ CAUTION

- To ensure a long useful life for the engine, avoid high revs, driving at high speed and making the engine work hard for approximately the first 15 minutes when the engine is cold. The phase until the engine is warm also depends on the outside temperature. If necessary, use the engine oil temperature»» page 70 as a guide.
- Additional lights and other accessories in front of the air inlet reduce the cooling effect of the coolant. At high outside temperatures and high engine loads, there is a risk of the engine overheating.
- The front spoiler also ensures proper distribution of the cooling air when the vehicle is moving. If the spoiler is damaged this can reduce the cooling effect, which could cause the engine to overheat. Seek specialist assistance.

### Service intervals

The service interval display appears on the instrument cluster screen and in the infotainment system.

There are different versions of instrument panels and infotainment systems, so the ver-

sions and instructions on the screens may vary.

CUPRA distinguishes between services *with* engine oil change (e.g. Oil change service) and services *without* engine oil change (e.g. Inspection).

In vehicles with **Services established by time or mileage**, the service intervals are already pre-defined.

In vehicles with **LongLife Service**, the intervals are determined individually. Thanks to technological progress, maintenance work has been greatly reduced. Because of the technology used by CUPRA, with this service you only need to change the oil when the vehicle so requires. To calculate this variation (max. 2 years), the vehicle's conditions of use and individual driving styles are considered. The advance warning first appears 20 days before the date established for the corresponding service. The kilometres (miles) remaining until the next service are always rounded up to the nearest 100 km (miles) and the time is given in complete days. The current service message cannot be viewed until 500 km after the last service. Prior to this, only lines are visible on the display.

### Inspection reminder

If a service or an inspection has to be carried out soon, a **service reminder** will be displayed when the ignition is switched on.

The figure displayed are the kilometres that can still be travelled or the time until the next service.

### Service due

When the time for a service or an inspection comes, an audible warning will be emitted when the ignition is switched on and the fixed key symbol  may appear on the instrument panel for a few seconds, along with one of the following messages:

- **Service now!**
- **Please have your vehicle inspected.**
- **Oil change service due!**
- **Oil change service and inspection due!**

### Consult a service notification

With the ignition switched on, the engine off and the vehicle at a standstill, the current **service notification** can be read:

*Check the date of the current service on the infotainment system*

- Press the function button  **Data > Settings > Service.**

*Checking the date on the digital instrument panel*

- The date of the service can only be read through the Service menu»» page 68.

### Resetting service interval display

If the service was **not** carried out by a specialised CUPRA dealer or any dealer in the SEAT network, the display can be reset as follows:

- The service interval display can only be reset through the Service menu»» page 68 .

**Do not** restart the indicator between the service intervals, otherwise the information displayed will be incorrect.

If the oil change service is reset manually, the service interval display changes to a fixed service interval, also in vehicles with **Flexible oil change service**.

#### Note

- The service message disappears after a few seconds, when the engine is started or when the **OK** button is pressed on the multifunction steering wheel.
- In vehicles with the LongLife system in which the battery has been disconnected for a long period of time, it is not possible to calculate the date of the next service. Therefore the service interval display may not be correct. In this case, bear in mind the maximum service intervals permitted »» page 314.
- If you reset the display manually, the next service interval will be indicated as in vehicles with fixed service intervals. For this reason we recommend that the service in-

terval display be reset by an authorised dealer.

## Using the instrument panel

### Introduction

With the ignition switched on, it is possible to read the different functions of the display by scrolling through the menus.

The multifunction display can only be controlled from the buttons on the multifunction steering wheel.

Some menu options can only be read when the vehicle is at a standstill.

#### WARNING

Distracting the driver in any way can lead to an accident and cause injuries.

- Never use the menus on the instrument panel display while the vehicle is in motion.

#### Note

After loading or changing the 12-volt battery, check the system settings. If the power supply is interrupted, the system settings might be incorrect or deleted.

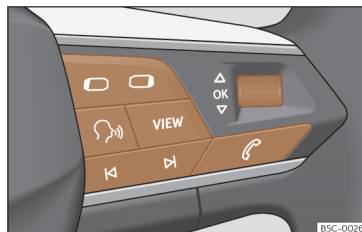

## Operation using the multifunction steering wheel



**Fig. 56** Right side of the multifunction steering wheel: buttons for using the instrument cluster's menus and information displays (depending on versions).

As long as a priority 1»» page 70 warning is active, it will not be possible to access any menu. Some warnings can be confirmed and hidden with the button **OK** of the multifunction steering wheel»» **Fig. 56** .

### Select a menu or an informative display

- Switch the ignition on.
- If a message or vehicle symbol is displayed, press the button **OK**»» **Fig. 56** ; if necessary, several times.
- To change menus, use buttons  or  »» **Fig. 56**.
- To open the menu or the information displayed, press the button **OK**»» **Fig. 56** or wait



a few seconds until the menu or the informative display opens automatically.

## Changing menu settings

- In the menu displayed, turn the right thumbwheel of the multifunction steering wheel»» Fig. 56 until the desired option of the menu is highlighted. The option appears framed.
- Press the button **OK**»» Fig. 56 to make the required modifications. A mark indicates that the system or function is activated.

## Back to menu selection

Press the button  or »» Fig. 56.

### Note

If when switching on the ignition warnings are shown about existing faults, it might not be possible to change the settings or show the information as described. In this case, go to a specialised workshop and request a repair.

## Button for the driver assistance systems

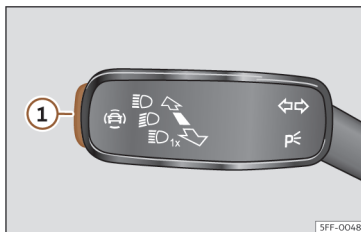

**Fig. 57** On the turn signal and main beam lever: button for driver assistance systems (depending on versions).



**Fig. 58** Left side of the multifunction steering wheel: button for driver assistance systems (depending on versions).

With the turn signal and main beam headlight lever button, you can activate or deacti-

vate the driver assistance systems displayed in the **Assistance systems** menu .

## Activating or deactivating a driver assistance system using the turn signal lever and main beam headlight

- Briefly press the  button to open the **Assistants** menu.
- Select the driver assistance system and activate or deactivate it»» page 78 . A mark indicates that driver assistance system is switched on.
- Next, confirm the selection by pressing the **OK** button on the multi-function steering wheel.

## Activating or deactivating a driver assistance system using the multifunction steering wheel

- Press the button »» Fig. 58 to open the **Aids** menu.
- Select the driver assistance system and activate or deactivate it. A mark indicates that driver assistance system is switched on.
- Next, confirm the selection by pressing the **OK** button on the multifunction steering wheel.

The driver assistance systems can also be switched on and off in the infotainment system, in the menu **Vehicle settings** »» page 86.

## Control lamps

### Control and warning lamps





The control and warning lamps are indicators of warnings >>> , faults or certain functions. Some control and warning lamps come on when the ignition is switched on, and switch off when the engine starts running, or while driving.





Depending on the model, additional text messages may be viewed on the instrument panel display. These may be purely informative or they may be advising of the need for action >>> page 64, Instrument panel.

Depending upon the equipment fitted in the vehicle, instead of a warning lamp, sometimes a symbol may be displayed on the instrument panel.









When certain control and warning lamps are lit, an audible warning is also heard.













### Red warning lamps

	Notification central lamp: additional information on the instrument panel display
	Parking brake on >>> page 245.
	Fault in the brake system >>> page 245.
	Fault in the steering system >>> page 210.









	Driver or passenger has not fastened seat belt >>> page 16.
	Engine cooling fluid >>> page 76.
	Engine oil pressure >>> page 293.
	Anomaly in the alternator >>> page 300.
	Press the foot brake >>> page 226.

### Yellow warning lamps

	Notification central lamp: additional information on the instrument panel display
	Front brake pads worn >>> page 245.
	Fault in the ESC or the system caused it to switch off; <b>OR</b> ESC or ASR operating >>> page 249.
	ESC switched off manually; <b>OR</b> ESC in Sport mode >>> page 249.
	Fault in the ABS >>> page 249.
	Rear fog light switched on >>> page 111.
	Fault in the emission control system >>> page 287.
<b>EPC</b>	Fault in the petrol engine management >>> page 287.
	Particulate filter blocked >>> page 287.

	Fault in the steering system >>> page 210.
	Tyre pressure monitor system >>> page 310.
	Fuel tank almost empty >>> page 75.
	Fault in airbag system and seat belt tensioners >>> page 25.
<b>OFF</b> 	Front passenger front airbag is disabled >>> page 25.
<b>ON</b> 	The front passenger front airbag is activated >>> page 25.
	Defective active cruise control (ACC) >>> page 231
	Lane Assist (lane keeping system) >>> page 234.
	Error in the lane assist warning system >>> page 234.
	Travel Assist error >>> page 238.
	Fault in the lighting of the vehicle >>> page 111.
	Low engine oil level >>> page 293.
	Fault in the gearbox >>> page 207.







## Green indicator lamps



	Turn lights or emergency lights on »» page 111.
	Trailer turn signals»» page 111 .
	Auto Hold activated»» page 248 .
	Press the foot brake»» page 201 .
	Cruise control system (GRA)»» page 220 ; OR speed limiter»» page 221
	Adaptive cruise control (ACC)»» page 227 .
	Lane assist active (Lane Assist) warning »» page 234.
	Travel Assist active»» page 237 .

## Blue indicator lamps

	Main beam on or flasher on»» page 111 .
---	---

## Other warning lamps

	Door(s), rear lid or bonnet open or not properly closed»» page 67 .
	Main beam assist (Light Assist)»» page 111 .
	Hill descent control (HDC)»» page 208 .
	Service interval display»» page 77 .
	Mobile phone connected by Bluetooth® .
	Mobile telephone battery charge status.

	Risk of freezing»» page 67 .
	Start-Stop system activated»» page 199 .
	Start-Stop system unavailable»» page 199 .

**⚠ WARNING**

If the warning lamps and messages are ignored, faults may occur in the vehicle, it may stall in traffic, or accidents and serious injuries may occur.

- Never ignore the warning lamps or text messages.
- Stop the vehicle safely as soon as possible.
- A faulty vehicle represents a risk of accident for the driver and for other road users. If necessary, switch on the hazard warning lamps and put out the warning triangle to advise other drivers.
- Before opening the bonnet, switch off the engine and allow it to cool.
- In any vehicle, the engine compartment is a hazardous area and could cause severe injuries»» page 289 .

## Infotainment system

### Introduction

The infotainment system brings together important vehicle functions and systems into a single central control unit, e.g. air conditioning, menu settings, radio equipment and the navigation system.

The actual number of menus available and the name of the various options will depend on the vehicle's electronics and equipment.

### General operating information

General information on the operation of the infotainment system, as well as on the warning and safety instructions that must be taken into account, is found in »» page 150.

### How to move through the different menus and select them

- Switch the ignition on.
- If the infotainment system is off, switch it on.
- The different menus are selected directly on the touch screen using texts, icons or buttons.

If the box is checked ✓, the function is activated.

Pressing the menu button < will always take you to the last menu used.

Any changes made using the settings menus are automatically saved on closing those menus.

**Scroll bar:** Some menus and functions show more content above or below those displayed on the screen at that time, for exam-

ple, long lists of settings. Press on the scroll bar and pull up or down.

### Tutorial

The first time you connect the Infotainment system, a system tutorial will open with a brief description of the main functions and how to use it.

### Help

In the **Help** menu can be found more information and tips for using the infotainment system.

### WARNING

Any distraction may lead to an accident, with the risk of injury. Operating the Infotainment system while driving could distract you from traffic.

## Explanation of the function buttons

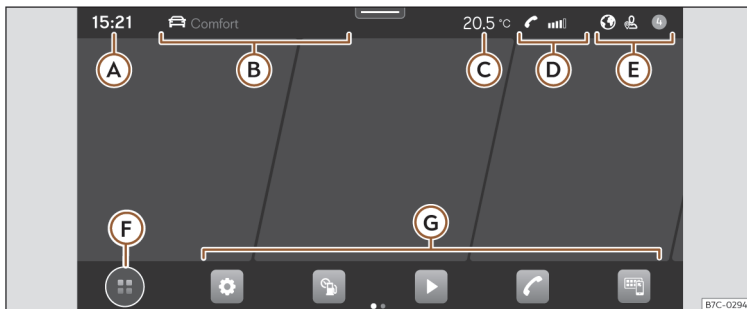

**Fig. 59** Schematic representation: Overview of the possible function buttons on the screen

#### Top part of the screen

- A** **Current time**
- B** **Driving profile and navigation information.** If the user has an active route, both the time and the distance to the destination are displayed. If there is no active route, the driving profile is displayed. On vehicles with no available driving profile, the current address is displayed whenever there is no active route.
- C** **Air conditioning information.** In vehicles with heated steering wheels or wind-screen heating, the corresponding icon

is displayed when these functions are enabled. If not, the current outside temperature is displayed.

- D** **Telephone information.** Information regarding your mobile device is displayed: available network signal strength, established Bluetooth connection, unanswered calls, new messages, battery status, etc.
- E** **Number of notifications and customization of the system depending on the user and connectivity.**

#### Bottom part of the screen

- F** **Main menu display mode:**
  - ⌘: main menu with the 6 main functions divided into 2 screens (3 + 3, customisable by the user by pressing on the function).
  - ⊕: main menu in mosaic mode (all functions of the Infotainment system)
- G** **Direct accesses to the functions of the Infotainment system (up to 10 functions, 5 + 5, customisable by the user).** By pressing on the icon, you can select/deselect the functions in question.

## Initial configuration wizard

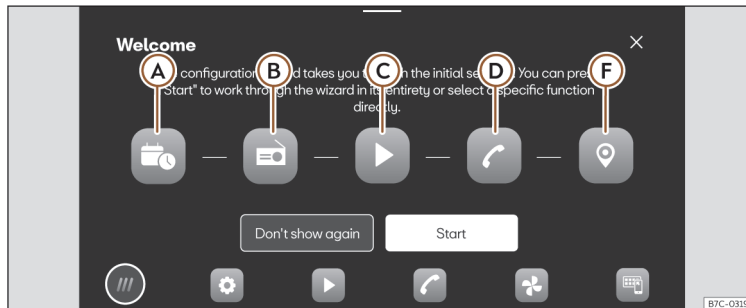

**Fig. 60** Schematic representation: Initial configuration wizard

The initial configuration wizard will help you to set up your Infotainment system the first time you switch it on.

Whenever you switch on the infotainment system, the initial setup screen will be displayed»» **Fig. 60** if any parameters have not been set (marked with “✓”) or if the **Don't show again** function button has not been pressed.

### Function button: Function

✕ Closes the Configuration Wizard.

### Function button: Function

A	Press to set day and time.
B	Press to search and store to memory the radio stations that have the best reception at that moment.
C	Press to go to the Online Media settings.
D	Press to link your mobile phone to the Infotainment system.

### Function button: Function

E	Press to select your home address using your current position or by manually entering an address.
Don't show again	Disables the possibility of changing the settings of the Infotainment system. If you want to run the initial configuration, it can be accessed through <b>Settings &gt; Initial configuration wizard</b> .
Start	Starts up the Configuration Wizard.
End	Once one or more settings have been applied, press to finalise the setup in the main menu of the wizard.

## Vehicle information

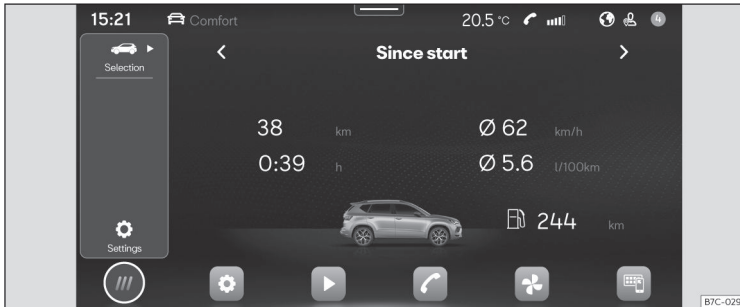
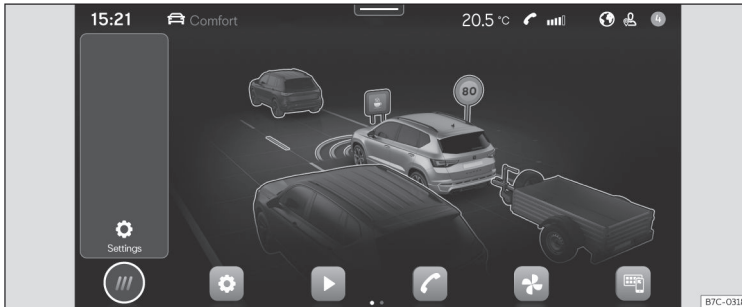

**Fig. 61** Schematic representation: Vehicle information and status

Pressing on > **Selection** and then on **Vehicle info** opens the **Vehicle information** menu with the following submenus:

- **Driving data:** The average consumption, average speed, distance travelled, trip duration and autonomy are shown. It has 3 memories: "Since start", "Long-term" and "Since refuel" >>> page 69 .
- **Vehicle status:** The warnings regarding faults, incidents, memorisation of the tyre pressure or information of the next inspection service are displayed.

## Assist systems and vehicle settings



**Fig. 62** Schematic representation: Assist systems and vehicle settings

The number of assist systems and settings depend on the version and the country in question.

#### ■ Driver assistance

- Automatic parking brake activation  
»» page 247.
- Park assist»» page 253 .
- Activate / deactivate ESC, stabilisation systems and brake assist»» page 249 .
- Activate / deactivate the Start-Stop system»» page 199 .
- Adaptive cruise control (ACC)  
»» page 226.
- Lane Assist (lane keeping system)  
»» page 234.
- Emergency brake assistance system (Front Assist)»» page 223 .
- Fatigue detection»» page 70 .
- Traffic sign recognition»» page 72 .
- Lane assist»» page 240 .



## Multifunction steering wheel

### Functions

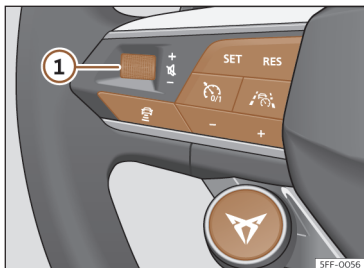

Fig. 63 Controls on the steering wheel.

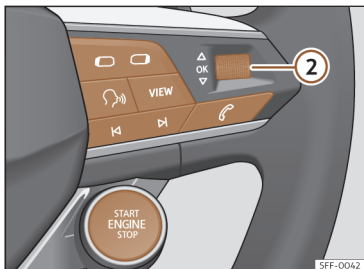

Fig. 64 Controls on the steering wheel.

The steering wheel includes multifunction modules from where it is possible to control the audio, telephone, navigation, voice control and assist functions without the driver needing to be distracted from the road.

### Buttons available depending on the version

Symbol	Function
①	<i>Turn:</i> Turn volume up/down <i>Press:</i> Mute volume
②	<i>Turn:</i> Search in the instrument panel menu. In Navigation mode, turn to zoom in/out of the map in the Digital Cockpit <i>Press:</i> Select the highlighted option in the instrument panel
⏮ ⏭	<i>Radio:</i> Search for the previous/next station. <i>Media:</i> Short press: previous/next track; long press: fast forward/rewind
☎	Activate phone menu (answer call, end call)
🔄	Switch between media and radio sources
◀ ▶	Change the instrument panel menu (previous/next)
🗣	Enable/disable voice control
<b>VIEW</b>	<i>Digital Cockpit:</i> Change digital panel views»» page 65
👤	Activate or deactivate steering wheel heating»» page 148

Symbol	Function
🕒	Connect/disconnect the Cruise control system»» page 220 / ACC »» page 226 / Speed limiter »» page 221
<b>SET RES</b>	<b>SET:</b> Activate ACC / Cruise control system / Limiter <b>RES:</b> Reset programmed ACC speed or cruise control system
- +	+ : Increase programmed speed - : Decrease programmed speed
🚗	Switching Travel Assist on and off »» page 236
🚗	Open the drive assist menu in the instrument panel
🚗	Modify the programmed ACC distance
🏠	Driving profile selection»» page 210
<b>START ENGINE STOP</b>	Starting and stopping the engine »» page 195

## Opening and closing

### Set of vehicle keys

#### Vehicle key

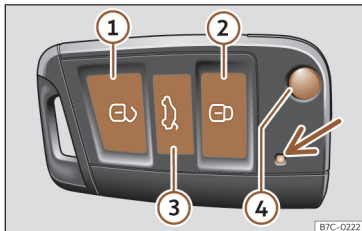

**Fig. 65** Assignment of buttons on the remote control key.

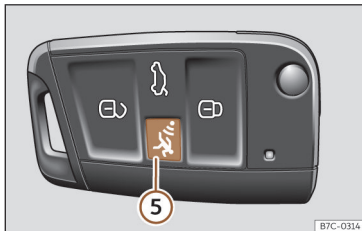

**Fig. 66** Vehicle key with alarm button.

- ① Unlock the vehicle
- ② Lock the vehicle
- ③ Unlock only the rear lid. Press the button until all the turn signals on the vehicle flash briefly. You have 2 minutes to open the rear lid. Once this time has passed, it will lock again. In addition, the lamp on the key flashes.
- ④ Folding the key shaft in and out
- ⑤ Alarm button. Only press in the event of an emergency! When the alarm button is pressed, the vehicle's sounds and the turn signals light up for a short time. Press again to disconnect.

With the vehicle key the vehicle may be locked or unlocked remotely»» page 90 .

The vehicle key includes an emitter and battery. The receiver is in the interior of the vehicle. The range of the vehicle key with remote control and new battery is several metres around the vehicle.

If it is not possible to open or close the vehicle using the remote control key, this should be re-synchronised»» page 90 or the battery changed»» page 89 .

Different keys belonging to the vehicle may be used.

#### Control lamp on the vehicle key

When a button on the vehicle key is pressed, the control lamp flashes»» Fig. 65 (arrow) once briefly, but if the button is held down for a longer period the control lamp flashes several times, such as in convenience opening.

If the vehicle key control lamp does not light up when the button is pressed, replace the key's battery»» page 89 .

#### Spare key

To obtain a spare key and other vehicle keys, the vehicle ID number is required.

Each new key contains a microchip which must be coded with the data from the vehicle electronic immobiliser. A vehicle key will not work if it does not contain a microchip or the microchip has not been encoded. This is also true for keys which are specially cut for the vehicle.

The vehicle keys or new spare keys can be obtained from a specialised CUPRA dealer or SEAT Official Service, a specialised workshop or an approved key service qualified to create this kind of key.

New keys or spare keys must be synchronised before use»» page 90 .

Key to»» Fig. 65

### ⚠ WARNING

- Never leave children or disabled persons in the vehicle. In case of emergency, they may not be able to leave the vehicle or manage on their own.
- An uncontrolled use of the key could start the engine or activate any electric equipment (e.g. electric windows), causing risk of accident. The doors can be locked using the remote control key. This could become an obstacle for assistance in an emergency situation.
- Never forget the keys inside the vehicle. An unauthorised use of your vehicle could result in injury, damage or theft. Therefore always take the key with you when you leave the vehicle.
- Never remove the key from the ignition if the vehicle is in motion. Otherwise, the steering could suddenly block and it would be impossible to steer the vehicle.

### ⓘ CAUTION

All of the vehicle keys contain electronic components. Protect them from damage, impacts and humidity.

### ⓘ Note

- Only use the key button when you require the corresponding function. Pushing the button unnecessarily could accidentally unlock the vehicle or trigger the alarm. It is

also possible even when you are outside the radius of action.

- Key operation can be greatly influenced by overlapping radio signals close to the vehicle working in the same range of frequencies, for example, radio transmitters or mobile telephones.
- Obstacles between the remote control and the vehicle, bad weather conditions and discharged batteries can considerably reduce the range of the remote control.
- If the buttons of the vehicle key are pressed or one of the central locking buttons >>> page 93 is pressed repeatedly in short succession, the central locking briefly disconnects as protection against overloading. The vehicle is then unlocked. Lock it if necessary.
- Spare remote control keys are available at your Technical Service, where they must be matched to the locking system.
- Up to five remote control keys can be used.

## To change the battery

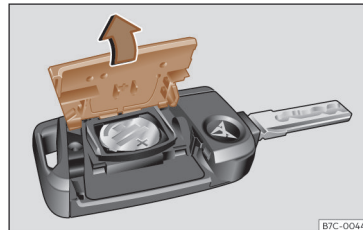

B7C-0044

**Fig. 67** Vehicle key: opening the battery compartment cover.

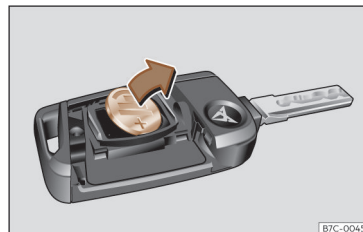

B7C-0045

**Fig. 68** Vehicle key: removing the battery.

CUPRA recommends you ask a specialised workshop to replace the battery.

The battery is located to the rear of the vehicle key, under a cover. »

## Changing the battery

- Unfold the vehicle key blade»» page 88 .
- Remove the cover from the back of the vehicle key»» Fig. 67 in the direction of the arrow »» ❶.
- Extract the battery from the compartment using a suitable thin object»» Fig. 68 .
- Place the new battery in the compartment as shown»» Fig. 68 , pressing in the opposite direction to that shown by the arrow »» ❶.
- Fit the cover as shown»» Fig. 67 , pressing it onto the vehicle key casing in the opposite direction to that shown by the arrow until it clicks into place.

### ⚠ WARNING

Swallowing a battery with a 20 mm diameter or any other button battery can cause serious and even fatal injuries within a very short time.

- Keep the vehicle key and key fobs with batteries out of reach of children.
- If you suspect that someone may have swallowed a battery, seek immediate medical attention.

### ❗ CAUTION

- If the battery is not changed correctly, the vehicle key may be damaged.
- Use of unsuitable batteries may damage the vehicle key. For this reason, always re-

place the dead battery with another of the same voltage, size and specifications.

- When fitting the battery, check that the polarity is correct.

### ♻ For the sake of the environment

Please dispose of your used batteries correctly and with respect for the environment.

## Synchronize the vehicle key

If the  button is pressed frequently outside of the vehicle range, it is possible that the vehicle can no longer be locked or unlocked using the key. In this case, the key must be resynchronised as described below:

- Unfold the vehicle key blade»» page 88 .
- If necessary, remove the cover from the driver door lever»» page 100 .
- Press the  button on the vehicle key. For this, it must remain with the vehicle.
- Open the vehicle within one minute using the key blade. The key has been synchronised.
- If necessary, fit the cap.

## Central locking

### Introduction

Central locking functions correctly when all the doors and the rear lid are correctly shut. If the driver door is open, the vehicle *cannot* be locked with the key.

If the vehicle has the Keyless Access locking and ignition system, it may only be locked with the ignition off and the driver's door closed.

### ⚠ WARNING

The incorrect use of the central locking system may cause serious injuries.

- The central locking system will lock all doors. A vehicle locked from the inside can prevent any non-authorized individual from opening the doors and accessing the vehicle. Nevertheless, in case of emergency or accident, locked doors will complicate access to the vehicle interior to help the passengers.
- Never leave children or disabled people alone in the vehicle. The central locking button can be used to lock all the doors from within. Therefore, passengers will be locked inside the vehicle. Individuals locked in the vehicle can be exposed to very high or very low temperatures.
- Depending on the time of the year, temperatures inside a locked and closed

vehicle can be extremely high or extremely low resulting in serious injuries and illness or even death, particularly for young children.

- Never leave individuals locked in a closed and locked vehicle. In case of emergency, they may not be able to exit the vehicle by themselves or get help.

## Description

Central locking allows all doors, the rear lid and the tank flap to be unlocked centrally:

- From outside, using the vehicle key  
»» page 92.
- From outside with the Keyless Access  
»» page 93 system,
- From inside, by pushing the central locking button»» page 93.

Various functions are available to improve the vehicle safety:

- Security system "Safe"»» page 96
- Self-locking system to prevent involuntary unlocking
- Selective unlocking system
- Automatic speed dependent locking and unlocking system (Auto Lock)
- Emergency unlocking system

## Self-locking system to prevent involuntary unlocking

It is an anti-theft system and prevents the unintentional unlocking of the vehicle. If the vehicle is unlocked and none of the doors (including the boot) are opened within 30 seconds, it re-locks automatically.

## Unlocking one side of the vehicle only

When you lock the vehicle with the key, the doors and the rear lid are locked. When you open the door, you can either unlock *only* the driver door, or all the vehicle doors. To select the required option, use the Infotainment system setting»» page 92.

## Automatic locking (Auto Lock)

The Auto Lock function locks the doors and the rear lid when the vehicle exceeds a speed of about 15 km/h (9 mph).

The vehicle is unlocked again when the ignition key is removed. Alternatively, the vehicle can also be unlocked via the central locking switch or by pulling one of the inside door handles.

In the event of an accident in which the airbags inflate, the doors will be automatically unlocked to facilitate access and assistance.

## Turn signals

The turn signals will flash twice when the vehicle is unlocked and once when the vehicle is locked.

If it does not flash, this indicates that one of the doors, the rear lid or the bonnet is not closed correctly.

## Accidental lock-out

The central locking system prevents you from being locked out of the vehicle in the following situations:

- If the driver door is open, the vehicle cannot be locked with the central locking switch  
»» page 93.

Lock the vehicle with the remote control key, when all the doors and the rear lid have been closed. This prevents the accidental locking of the vehicle.

## Note

- **Never leave any valuable items in the vehicle unattended. Even a locked vehicle is not a safe.**
- **If the LED on the driver door sill lights up for about 30 seconds when the vehicle is locked, the central locking system or anti-theft alarm is not working properly. You should have the fault repaired at a specialised CUPRA dealer, SEAT Official Service or specialised workshop.**

- Vehicle interior monitoring by the anti-theft alarm system will only function as intended if the windows and sunroof are closed.

## Central locking settings

Central locking settings can be changed in the Infotainment system.

### Unlocking doors

- Press the function button  > **Settings** > **Opening and closing** > **Central locking** > **Door unlocking**.

You can choose to unlock **all** the doors or only the **driver door** when you unlock the vehicle. In all the options, the fuel tank flap is also unlocked.





With the **Driver** setting, when you press the  button on the remote control key once, only the driver door is unlocked. If that button is pressed twice, the rest of the doors and the rear lid will be unlocked.

If the  button is pressed, all the vehicle doors are locked. At the same time, a confirmation signal is heard.

## Unlock and lock from the outside



Fig. 69 Remote control key: buttons.

- Lock: press the  button. **Fig. 69**
- Locking the vehicle without the “Safe” security system: push the  button again and hold for 2 seconds.
- Unlock: press the  button.
- Unlocking the rear lid: hold down the  button for at least 1 second.

The vehicle will be locked again automatically if you do not open one of the doors or the rear lid within 30 seconds after unlocking the car. This function prevents the vehicle from remaining unlocked if the unlocking button is pressed by mistake. This does not apply if you press the  button for at least one second.

## Selective unlocking system

The selective unlocking system allows you to only unlock the driver door and the fuel tank flap. All other doors and the rear lid remain locked.

*Unlocking the driver's door and tank flap:*

- Press (once) the  button on the remote control key or turn the key *once* in the opening direction.

*Unlocking all the doors, the rear lid and the tank flap simultaneously:*

- Within 5 seconds, press (twice) the  button on the remote control key, or turn the key *twice* within 5 seconds in the opening direction.

The Safe security system and the anti-theft alarm deactivate immediately when only the driver door is opened.

In vehicles with Infotainment system, you can programme the security central locking system directly»» page 92.

### WARNING

Observe the safety warnings »»  in Locking system “Safe” on page 97.

### Note

- Do not use the remote control key until the vehicle is visible.

- Other functions of the remote control key»» page 106, Convenience open/close function.

### Unlocking and locking from the inside



**Fig. 70** Driver's door: central locking switch.

- Lock: press the »» **Fig. 70** button.
- Unlock: press the »» **Fig. 70** button.

Please note the following when using the central locking switch to lock your vehicle:

- It is not possible to open the doors or the rear lid from the *outside* (for safety reasons, e.g. when stopped at traffic lights).
- The LED in the central locking switch lights up when all the doors are closed and locked.

- You can open the doors individually from the inside by pulling the inside door handle.
- In the event of an accident in which the airbags inflate, doors locked from the inside will be automatically unlocked to facilitate access and assistance.

#### WARNING

- The central locking switch also works with the ignition switched off, except when the "safe" system is activated.
- The central locking switch does not operate if the vehicle is locked from the outside and the security system is switched on.
- Locked doors could delay assistance in an emergency. Do not leave anyone, especially children, in the vehicle.

#### Note

Your vehicle will lock automatically when it reaches a speed of about 15 km/h (9 mph) (Auto Lock)»» page 91. You can unlock the vehicle again using the button on the central locking switch.

### Unlock and lock the vehicle with Keyless Access

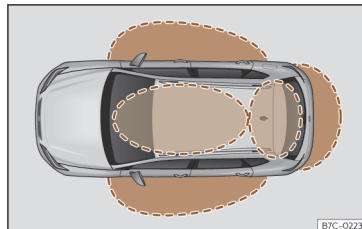

**Fig. 71** Keyless Access: proximity zones.

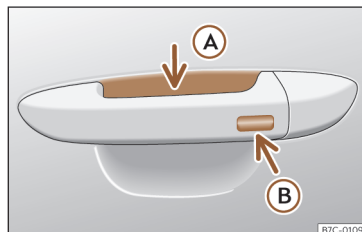

**Fig. 72** Door handle: sensor surfaces

Depending on the equipment, the vehicle may have the Keyless Access system.

Keyless Access is a key-free locking and ignition system to unlock and lock the vehicle without actively using its key. To do this, all that is required is to have a valid vehicle key »

in the detection area where you are attempting to access the vehicle»» **Fig. 71** and to touch one of the sensor surfaces on the door handles»» **Fig. 72** or operate the *soft-touch*/handle on the rear lid  
»» page 101 »» ❶.

### Automatic vehicle unlock

The vehicle can be unlocked and locked via the front doors only. When doing so, the remote control key must be no further than approx. 1.5 m away from the door handle.

It does not matter where you carry the key, e.g. in your jacket pocket.

Once the doors have been locked, they cannot be opened again immediately. This will enable you to check that the doors are properly closed.

If you wish you may unlock *only* the corresponding door or the entire vehicle. The necessary adjustments can be performed in vehicles with a driver information system  
»» page 86.

### General information

If a valid key is in the proximity of the car, »» **Fig. 71** the Keyless Access locking and starting system gives the key entry as soon as one of the sensor surfaces on the door handles is touched or the *softtouch*/handle on the rear lid is operated.

The following features are then available without having to use the vehicle key actively:

- *Keyless Entry*: unlocking the vehicle using the handles of the front doors or the *soft-touch*/handle on the rear lid.
- *Keyless Exit*: locking the vehicle using the sensor of the driver or passenger door handle.
- *Easy Open*: opening the rear lid moving one foot below the rear bumper  
»» page 104.
- *Press & Drive*: keyless starting of the engine with the starter button»» page 195.

The central locking and locking systems operate in the same way as a *normal* locking and unlocking system. Only the controls change.

Unlocking the vehicle is confirmed with a *double* flash of the indicator lights; locking by a *single* flash.

If the vehicle is locked and then all doors and the rear lid are closed leaving the last key used inside the vehicle and none outside, the vehicle will **not** lock **immediately**. All the vehicle's indicator lights will flash *four times*. The vehicle will lock after a few seconds if you do not open any door or the rear lid.

The vehicle will lock again after a few seconds if you unlock the vehicle but fail to open any door or boot hatch.

### Unlocking and opening the doors (Keyless-Entry)

- Grip one of the front door handles. When you do this, you touch the sensor surface »» **Fig. 72** ❶ (arrow) of the handle and the vehicle unlocks.
- Open the door.

On vehicles with selective opening or information system configuration, pulling the door handle twice will unlock all doors.

### In vehicles without the “Safe” security system: closing and locking the doors (Keyless-Exit)

- Switch the ignition off.
- Close the driver's door.
- Touch (*once*) the locking sensor surface »» **Fig. 72** ❷ (arrow) on one of the front door handles. The door that is used must be closed.

### In vehicles with the “Safe” security system: closing and locking the doors (Keyless-Exit)

- Switch the ignition off.
- Close the driver's door.



• Touch (once) the sensor surface»» **Fig. 72** **B** (arrow) on one of the front door handles. The vehicle locks with the “Safe” security system»» page 96. The door that is used must be closed.

• Touch (twice) the sensor surface»» **Fig. 72** **B** (arrow) of one of the front door handles to lock the vehicle without activating the “Safelock” security system»» page 96.

### Unlocking and locking the boot hatch

When the vehicle is locked, the rear lid automatically unlocks on opening if there is a valid vehicle key in the proximity zone »» **Fig. 71**.

Open or close the rear lid *normally*.

After closing, the hatch locks automatically. If the complete vehicle is unlocked, the rear lid will **not** lock automatically after closing it.

### What happens when locking the vehicle with a second key

If there is a vehicle key inside the vehicle and it is locked from the outside with a second vehicle key, the key inside the vehicle is blocked for engine ignition»» page 195. In order to enable engine ignition, press the  button on the key inside the vehicle.

### Automatically disabling sensors

If the vehicle is not locked or unlocked for a long period of time, the proximity sensors on

the passenger doors are automatically disabled.

If one of the sensor surfaces on the door handles is often activated in an unusual manner with the vehicle locked (e.g. by the branches of a bush rubbing against it), all proximity sensors are disabled for a certain period of time.

Sensors will again be enabled:

- After a time.
- **OR:** if the vehicle is unlocked with the button  on the key.
- **OR:** if the boot is opened.
- **OR:** if the vehicle is unlocked manually with the key.

### Keyless Access temporary disconnection function

You can deactivate the vehicle's Keyless Access unlocking for one locking and unlocking cycle.

- Move the gear lever to position **P** since otherwise the vehicle cannot be locked.
- Close the door.
- Push the central locking button  on the remote control and touch the locking sensor surface of the driver door handle »» **Fig. 72** **B** within the following 5 seconds. Do not grasp the door handle; otherwise the vehicle will not unlock. Deactivation is also

possible if the vehicle is locked through the driver's door lock.

- To check that the function has been deactivated, wait at least 10 seconds, grip and pull on the door handle. The door should not open.

The next time the door can only be unlocked via the remote control or the lock cylinder. The next time the door is locked/unlocked, Keyless Access will be active again.

### Convenience functions

To close all the electric windows and the sunroof using the **comfort function**, keep a finger for a few seconds on the locking sensor surface»» **Fig. 72** **B** (arrow) of the door handle until the windows and roof have closed.

How the **doors open** when touching the sensor surface on the door handle will depend on the settings that have been activated in the infotainment system, using the button  > **Settings** > **Opening and Closing**.

### CAUTION

The sensor surfaces on the door handles could engage if hit with a water jet or high pressure steam if there is a valid vehicle key in the proximity. If at least one of the electric windows is open and the sensor surface »» **Fig. 72** **B** (arrow) on one of the handles is

activated continuously, all windows will close.

### Note

- If the vehicle battery has little or no charge, or the vehicle key battery is almost or entirely out of charge, you will probably not be able to lock or unlock the vehicle with the Keyless Access system. The vehicle can be unlocked or locked manually >>> page 100.

- To control the proper locking of the vehicle, the release function is disabled for approx. 2 seconds.

- If the message **Keyless access system faulty** is displayed on the screen of the dash panel, abnormalities may occur in the operation of the Keyless Access system. Contact a specialised workshop. To do so, CUPRA recommends going to a specialised CUPRA dealer or any SEAT dealership.

- Depending on the function set on the infotainment system for the mirrors, the exterior mirrors will unfold and the surround lighting will come on when unlocking the vehicle using the sensor surface on the driver and passenger door handles >>> page 121.

- If there is no valid key inside the vehicle or the system fails to detect one, a warning will display on the dash panel screen. This

could happen if any other radio frequency signal interferes with the key signal (e.g. from a mobile device accessory) or if the key is covered by another object (e.g. an aluminium case).

- If the sensors are very dirty, e.g. have a layer of salt, the correct functioning of the sensors on the door handles may be affected. In this case, clean the vehicle.

- The vehicle can only be locked if the selector lever is in the P position.

- To improve the safety of your vehicle, the remote control of the system is equipped with a position sensor. If this remote control does not detect movement for a certain length of time, the system will conclude that the vehicle cannot be opened (e.g. on a night table) so it will be disabled.

### Locking system “Safe”<sup>1)</sup>

When the vehicle is blocked, the “Safe” security system puts the door handles out of operation and prevents unauthorised persons for entering. The doors cannot be opened from inside >>> .

Depending on the vehicle, when switching the ignition off, a warning may be displayed

on the control panel screen stating that the “Safe” security system is activated.

**Lock the vehicle and activate the “Safe” security system.**

- Press the locking button  *once* on the vehicle key.

**Lock the vehicle without activating the “Safe” system.**

- Press the locking  button on the vehicle key *twice*.

- **OR:** touch the sensor surface on the outside of the door handle *twice* >>> **Fig. 72** 

**When the “Safe” security system is disabled, the following needs to be taken into account:**

- The vehicle can be unlocked and opened from the inside using an door handle.
- The anti-theft alarm is activated.
- The vehicle interior monitoring system and the anti-tow system are disabled.

**“Safe” status**

The flashing frequency of the diode in the door sill immediately confirms the process. Initially, the diode flashes in a fast sequence for a brief period, then it stops for

<sup>1)</sup> Available depending on market and version.

approximately 30 seconds and, lastly continues flashing slowly.

### WARNING

Do not leave anyone (especially children) in the vehicle if it is locked from the outside and the “Safe” security system is activated, as the doors and windows cannot then be opened from the inside. Locked doors could delay assistance in an emergency.

## Anti-theft alarm system

### Description

The anti-theft alarm makes it more difficult to break into the vehicle or steal it. The system will initiate acoustic and optical warning signals when your vehicle is tried to be forced.

The anti-theft alarm is automatically turned on when the vehicle is locked with the key. The system is immediately activated and the turn signal light located on the driver door will flash along with the turn signals, indicating that the alarm and the locking security system (double lock) have been turned on.

If any of the doors or the bonnet are open, they will not be included in the protection zones of the vehicle when the alarm is connected. If the door or the bonnet are subse-

quently closed, they will be automatically included in the protection areas of the vehicle and the turn signals will flash accordingly when the doors close.

- The turn signal light will flash twice on opening and deactivating the alarm.
- The turn signal light will flash once on closing and activating the alarm.

### When does the system trigger an alarm?

The anti-theft alarm siren will be triggered for about 30 seconds alongside a sound and optical (flashing) warning signals and will be repeated about ten times when the vehicle is locked and the following unauthorised actions are attempted:

- Opening a door that is mechanically unlocked using the vehicle key without switching on the ignition in the next 15 seconds (in certain markets, such as the Netherlands, there is no 15 second waiting time and the alarm is activated immediately on opening the door).
- A door is opened.
- Opening the bonnet.
- The rear lid is opened.
- When the ignition is switched on with a non-authorized key.
- Undue manipulation of the alarm.
- Disconnection of the vehicle battery.

- Movement inside the vehicle (in vehicles with interior monitoring»» page 98).
- When the vehicle is towed (in vehicles with anti-tow system»» page 98).
- When the vehicle is raised (in vehicles with anti-tow system»» page 98).
- When the vehicle is transported on a ferry or by rail (vehicles with an anti-tow system or vehicle interior monitoring»» page 98).
- When a trailer connected to the anti-theft alarm system is disconnected.

### How to turn OFF the alarm

- Unlock the vehicle with the unlock button  of the key.
- **OR:** turn the ignition on with a valid key.

If the driver's door is unlocked mechanically using the key, the ignition must be turned on within 15 seconds of opening the door.

Otherwise, the alarm will trigger for 30 sec. and the ignition will be blocked.

### CAUTION

If the anti-theft security system is switched off, the vehicle interior monitoring and the tow-away protection are automatically disconnected. »

**i Note**

- After 28 days, the indicator light will be switched off to prevent the battery from exhausting if the vehicle has been left parked for a long period of time. The alarm system remains activated.
- If, after the audible warning goes off, another monitored area is accessed (e.g. the rear lid is opened after a door has been opened), the alarm is triggered again.
- The anti-theft alarm is not activated when the vehicle is locked from within using the central locking button .
- If the driver door is unlocked mechanically with the key, only the driver door is unlocked, the rest of the doors remain locked. Only when the ignition has been turned on will the other doors be available – but not unlocked – and the central locking button will be activated.
- If the vehicle battery is run down or flat then the anti-theft alarm will not operate correctly.
- Vehicle monitoring remains active even if the battery is disconnected or not working for any reason.
- The alarm is triggered immediately if one of the battery cables is disconnected while the alarm system is active.

**Interior monitoring and the anti-tow system**

It is a monitoring or control function incorporated in the anti-theft alarm which detects unauthorised vehicle entry by means of ultrasound.



The vehicle interior monitoring and anti-tow sensor (tilt sensor) are automatically switched on when the anti-theft alarm is switched on. In order to activate it, all the doors and the rear lid must be closed.

If the “Safe”>>> page 96 security system is switched off, the vehicle interior monitoring and the tow-away protection are automatically disconnected.

**Activation**

- It is automatically switched on when the anti-theft alarm is activated.

**Deactivation**

- Open the vehicle with the key, either mechanically or by pressing the  button on the remote control. The time period from when the door is opened until the ignition is turned on should not exceed 15 seconds, otherwise the alarm will be triggered.
- Press the  button on the remote control twice. The volumetric sensor and tilt sensors will be deactivated. The alarm system remains activated.

The vehicle interior monitoring and the anti-tow system are automatically switched on again next time the vehicle is locked.

If you wish to switch off the vehicle interior monitoring and the anti-tow system, it must be done each time that the vehicle is locked; if not, they will be automatically switched on.

The vehicle interior monitoring and the anti-tow system should be switched off if animals are left inside the locked vehicle (otherwise, their movements will trigger the alarm) or when, for example, the vehicle is transported or has to be towed with only one axle on the ground.

**Deactivation through the infotainment system**

- Turn off the ignition and select: button  > **Settings** > **Opening and closing** > **Central locking** > **Interior monitoring**.
- When the vehicle is locked now, the vehicle interior monitoring and the tow-away protection are switched off until the next time the door is opened.

**False alarms**

Interior monitoring will only operate correctly if the vehicle is completely closed. Please observe related legal requirements.

The following cases may cause a false alarm:

- Open windows (partially or fully).
- Panoramic/tilting sunroof open (partially or completely).
- Movement of objects inside the vehicle, such as loose papers, items hanging from the rear vision mirror (air fresheners), etc.

### Note

- If the vehicle is relocked and the alarm is activated without the volumetric sensor function, relocking will activate the alarm with all its functions, except the volumetric sensor. This function is reactivated when the alarm is switched on again, unless it is deliberately switched off.
- If the alarm has been triggered by the volumetric sensor, this will be indicated by a flashing of the warning lamp on the driver door when the vehicle is opened. The flash is different to the flash indicating the alarm is activated.
- The vibration of a mobile phone left inside the vehicle may cause the vehicle interior monitoring alarm to trigger, as both sensors react to movements and shakes inside the vehicle.
- If on activating the alarm, any door or the rear lid is open, only the alarm will be activated. The vehicle interior monitoring and the anti-tow system will only be activated

once all the doors are closed (including the rear lid).

## Doors

### Introduction

The doors and rear lid can be locked manually and partially opened, for example if the key or the central locking is damaged.

### WARNING

Opening and closing doors carelessly can cause serious injury.

- If the vehicle is locked from outside, the doors and windows cannot be opened from the inside.
- Never leave children or disabled people alone in the car. They could be trapped in the car in an emergency and will not be able to get themselves to safety.
- Depending on the time of the year, temperatures inside a locked and closed vehicle can be extremely high or extremely low resulting in serious injuries and illness or even death, particularly for young children.

### WARNING

Getting in the way of the doors and the rear lid is dangerous and can lead to serious injury.

- Open and close the doors and the rear lid only when there is nobody in the way.

### CAUTION

When opening and closing in an emergency, carefully disassemble components and then reassemble them carefully to avoid damage to the vehicle.

## Emergency unlocking or locking of the driver's door

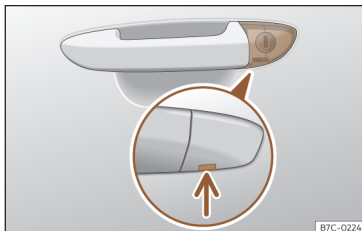

**Fig. 73** Driver door handle: Concealed lock cylinder.

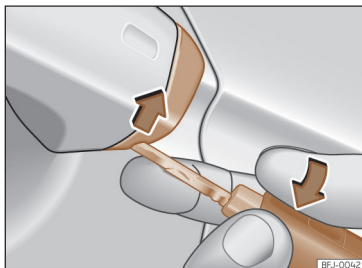

**Fig. 74** Driver door handle: lever the cover off

If the central locking system should fail to operate, the driver door can still be locked and unlocked by turning the key in the lock.

As a general rule, when the driver door is locked manually all other doors are locked. When it is unlocked manually, only the driver door opens. Please observe the instructions relating to the anti-theft alarm system >>> page 97.

- Unfold the vehicle key blade >>> page 88 .
- Insert the key shaft into the lower opening in the cover on the driver door handle >>> Fig. 74 then remove the cover upwards.
- Insert the key blade into the lock cylinder to unlock or lock the vehicle.

### Special characteristics

- The anti-theft alarm will remain active when vehicles are unlocked. However, the alarm will not be triggered >>> page 97 .
- After the driver door is opened, you have 15 seconds to switch on the ignition. Once this time has elapsed, the alarm is triggered.
- Switch the ignition on. The electronic immobilizer recognises a valid vehicle key and deactivates the anti-theft alarm system.

#### **i** Note

**The anti-theft alarm is not activated when the vehicle is locked manually using the key shaft >>> page 90 .**

## Emergency lock of doors without lock cylinders



**Fig. 75** Locking the door manually.

If the central locking system should fail to work at any time, doors with no lock cylinder will have to be locked separately.

The emergency lock is located on the front of the front passenger's door and the rear doors. It can only be seen if the door is open.

- Pull the cap out of the opening.
- Insert the key in the inside slot and turn it to the right as far as it will go (if the door is on the right side) or to the left (if the door is on the left side).
- Replace the cap.

Once the door has been closed it can no longer be opened from the outside. Pull the interior door handle once to unlock and open the door.

## Childproof locks



**Fig. 76** Childproof lock on the left hand side door.

The childproof lock prevents the rear doors from being opened from the inside. This system prevents minors from opening a door accidentally while the vehicle is running.

This function is independent of the vehicle electronic opening and locking systems. It only affects rear doors. It can only be activated and deactivated manually, as described below:

### Activating the childproof lock

- Unlock the vehicle and open the door in which you wish to activate the childproof lock.
- With the door open, rotate the groove in the door using the ignition key, clockwise for the left hand side doors»» **Fig. 76** and

anti-clockwise for the right hand side doors.

### Deactivating the childproof lock

- Unlock the vehicle and open the door whose childproof lock you want to deactivate.
- With the door open, rotate the groove in the door using the ignition key, anti-clockwise for the left hand side doors»» **Fig. 76** and clockwise for the right hand side doors.

Once the childproof lock is activated, the door can only be opened from the outside.

## Rear lid

### Introduction

The rear lid unlocks and locks together with the doors.

On vehicles with Keyless Access, the rear lid unlocks automatically when it is opened »» page 93.

### **⚠ WARNING**

Careless and unsuitable locking, opening and closing of the rear lid can cause accidents and serious injury.

- The rear lid must not be opened when the reverse or rear fog lights are lit. This may damage the tail lights.
- Do not close the rear lid by pushing it down with your hand on the rear window. The glass could smash. Risk of injury!
- Ensure the rear lid is locked after closing it. If not, it may open unexpectedly while driving.
- Closing the rear lid without observing and ensuring it is clear could cause serious injury to you and to third parties. Make sure that no one is in the path of the rear lid.
- Never drive with the rear lid open or half-closed, exhaust gases may penetrate into the interior of the vehicle. Danger of poisoning!
- Never leave the vehicle unattended or allow children to play inside or next to it, especially if the rear lid is open. Children could enter the luggage compartment, close the rear lid and become trapped. A locked vehicle can reach extremely high and low temperatures, depending on the time of year, thus causing serious injuries, illness or even death.

### **ⓘ CAUTION**

Before opening or closing the rear lid, make sure that there is enough space to open or close it, e.g. when pulling a trailer or in a garage. »

## Note

Before closing the rear lid, make sure that the key has not been left inside the luggage compartment.

## Opening and closing the rear lid

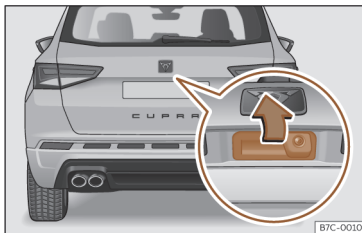



Fig. 77 Rear lid: handle

The rear lid opening system operates electrically. It is activated by exerting slight pressure on the handle»» Fig. 77.

To lock or unlock the rear lid, press the  or  buttons of the vehicle key.

A warning appears on the instrument panel display if the rear lid is open or not properly closed. An audible warning is also given if it is opened while the vehicle is moving faster than 6 km/h (4 mph).

## Opening and closing

- To open: place slight pressure on the handle. The rear lid opens automatically.
- To close: hold one of the handles on the inner trim and close it by moving it downwards, or press the button on the rear lid »» Fig. 78.

If the doors are locked, the rear lid is also locked.

## Rear lid with electric opening and closing

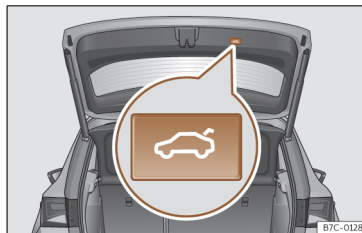

Fig. 78 Rear lid: button to close the rear lid.

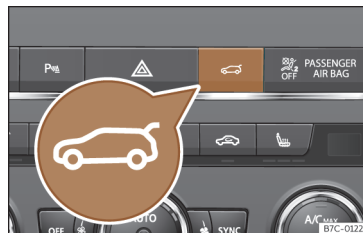



Fig. 79 Centre console: button to open and close the rear lid.





## Opening the rear lid

- Unlock the vehicle »» page 90 and briefly press the handle of the rear lid. On vehicles with Keyless Access you can directly press the handle of the rear lid. The rear lid is unlocked if an authorised key is recognised in the proximity of the vehicle.
- **OR:** press the button on the centre console for at least one second »» Fig. 79. The button also works when the ignition is switched off.
- **OR:** press and hold the  button of the vehicle key for approx. 1 second. If the vehicle is locked, only the rear lid is unlocked (the doors remain locked).
- **OR:** on vehicles with Keyless Access and sensor-controlled opening you can open the rear lid by moving one foot in the area of the sensors located below the rear bumper (Easy





Open»» page 104 ). The rear lid will be automatically opened.

### Closing the rear lid

- Briefly press the  button on the rear lid »» Fig. 78 »»  in Introduction on page 101.
- **OR:** press the  button located on the centre console until the rear lid is closed »» Fig. 79.
- **OR:** on vehicles with Keyless Access, press and hold the  vehicle key button until the rear lid is closed, or move one foot into the area of the sensors located below the rear bumper (Easy Open)»» page 104 . The vehicle key must be in the Keyless Access system detection zone at the rear outside the vehicle.
- **OR:** manually move the rear lid in the direction of closing until it closes automatically.
- The rear lid goes down automatically to the final position and also closes automatically »»  in Introduction on page 101.

### Interrupting opening or closing

After beginning to open or close the rear lid, the action can be halted by pressing one of the  buttons.

If you press one of the  buttons again, the rear lid will move again in the original direction.

If the rear lid is met with resistance or an obstacle during the automatic opening or closing, opening or closing will be interrupted immediately. For the closing process, the rear lid opens again slightly.

- Check why it has not been possible to open or close the rear lid.
- Try to open or close the rear lid again.
- If necessary, the rear lid can be opened or closed by hand using reasonable force.

### Particular features if towing a trailer

If the factory-fitted towing bracket is electrically connected to a trailer»» page 274 , the electric rear lid can only be opened or closed with the buttons on the rear lid itself or by using the Easy Open function.

### Acoustic warnings

Throughout the process of opening or closing the rear lid, acoustic warnings can be heard. Exception: when the rear lid is opened manually using the handle or the Easy Open function with the movement of the foot or closed using the button on the rear lid itself»» Fig. 78 .

### Modifying and memorising the opening angle

If the space behind or above the vehicle is less than the travel area of the rear lid, you can change the opening angle of the rear lid.

To memorise a new opening angle, the rear lid must be open at least halfway.

- Interrupt the opening process in the desired position.
- Press the  button»» Fig. 78 on the rear lid for at least 3 seconds.

The opening angle is memorised. Memorisation is indicated by blinking of the hazard warning lights and an audible warning.

### Resetting and memorising the opening angle

For the rear lid to reopen completely, the opening angle must be reset and memorised again.

- Release the rear lid and open it to the memorised height.
- Lift the rear lid by hand as far as it goes. To do this, some force will have to be used.
- Press the  button»» Fig. 78 on the rear lid for at least 3 seconds.
- This resets and memorises the factory-set opening angle. Memorisation is indicated by »»

blinking of the hazard warning lights and an audible warning.

### Automatic protection against overheating

If the system is operated repeatedly in a short space of time, it automatically switches off to prevent overheating.

Once the system is cool again, the function can be reused. Until then, the rear lid can only be opened and closed by hand using reasonable force.

If with the rear lid open the vehicle battery is disconnected»» page 299 or the corresponding fuse burns out»» page 56, the system will have to be reset. This requires closing the rear lid completely once.

### Emergency unlocking

»» page 105

#### WARNING

If a lot of snow builds up on the rear lid or it is heavily loaded, the rear lid may not open or, after opening, it may lower by itself due to the extra weight and cause serious injury.

- Do not open the rear lid when there is a lot of snow on it or when carrying a load (e.g. on a rack).
- Before opening the rear lid, remove the snow or the load.

### Rear lid with sensor-controlled opening and closing (Easy Open)



**Fig. 80** Rear lid with sensor-controlled opening (Easy Open).

If there is a valid vehicle key in the proximity of the rear lid, it is possible to unlock and open or close it moving one foot in the area of the sensors located under the rear bumper.

- Switch the ignition off.
- Stand in front of the rear bumper, in the middle.
- With a brisk movement, bring your foot and lower leg as close as you can to the bumper. The lower part of the leg needs to be close to the upper sensor area and your foot must be close to the lower sensor area »» **Fig. 80** ①.

- Quickly remove your foot and lower leg from the sensor areas»» **Fig. 80** ②. The rear lid will be automatically opened.
- If the rear lid fails to open, repeat the procedure after a few seconds.

The third brake light flashes once to show the boot has opened with the Easy Open function.

The rear lid can be closed with another foot movement similar to the opening one (provided a valid vehicle key is in the proximity of the rear lid).

When closed, the rear lid automatically locks if the vehicle has been locked beforehand and there is no valid key inside.

While the rear lid is in motion (either opening or closing), it can be stopped with another foot movement similar to the opening one (provided a valid vehicle key is in the proximity of the rear lid).

The Easy Open feature is not available or only has limited availability in the following situations (examples):

- If the rear bumper is very dirty.
- If the rear bumper is wet with salt water, e.g. after having driven on gritted roads.
- If the vehicle has been equipped at a later time with a tow bracket.

In the event of heavy rain, the Easy Open feature may take a little longer to open the boot or may deactivate automatically, to avoid the boot opening by accident, e.g. because of the running water.

The Easy Open function can be connected and disconnected permanently in the infotainment system using the button  > **Settings > Opening and closing** >> page 86.

### WARNING

If there is a valid key in the proximity of the rear lid, in some cases the Easy Open function may be accidentally activated and the rear lid will open, for example, when sweeping under the rear bumper, when directing a water jet or high pressure steam to the area or when carrying out maintenance work or repairs in that area. If accidentally opened, the rear lid could injure somebody situated in its area of operation or cause material damage.

- Therefore, always make sure that there is no unsupervised valid key in the area near the rear lid.
- Before carrying out any maintenance or repair work on the vehicle, always disable the Easy Open feature via the infotainment system.
- Before washing the vehicle, always disable the Easy Open feature via the infotainment system.

- Before attaching a bicycle rack or a trailer, >>> page 274, always disable the Easy Open feature via the infotainment system.

### Emergency unlocking of the rear lid

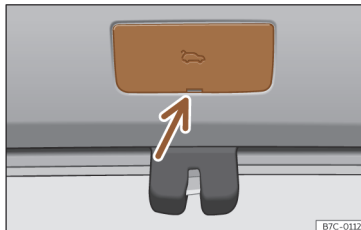

**Fig. 81** Detail of the luggage compartment: access to emergency unlocking.

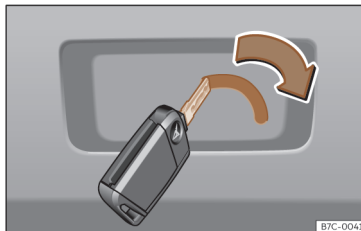

**Fig. 82** Detail of the luggage compartment: emergency unlocking

The rear lid can be unlocked from inside in the event of an emergency (e.g. no battery).

There is a groove in the luggage compartment allowing access to the emergency opening mechanism.

### Unlocking the rear lid from inside the luggage compartment



- Remove the cover using the key blade as a lever >>> **Fig. 81**.
- Insert the key blade into the slot and move the key in the direction of the arrow until the lock unlocks >>> **Fig. 82**.

## Window controls

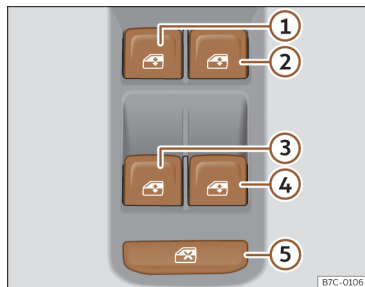
### Electrically opening and closing the windows



**Fig. 83** Detail of the driver's door: window controls.

- Opening the window: press the button .
- Closing the window: pull the button .

#### Buttons on the driver door

- ① Window on the front left door
- ② Window on the front right door
- ③ Window on the rear left door
- ④ Window on the rear right door
- ⑤ Safety switch for deactivating the electric window buttons in the rear doors.

The front and rear electric windows can be operated by using the controls on the driver door. The other doors each have a switch for their own window.

Always close the windows fully if you park the vehicle or leave it unattended .

You can use the electric windows for approx. 10 minutes after switching off the ignition if neither the driver door nor the front passenger door have been opened.

#### Safety switch

The safety control  **Fig. 83** ⑤ on the driver door can be used to disable the electric window buttons on the rear doors.

*Safety switch not pressed:* buttons on rear doors are activated.

*Safety switch pressed:* buttons on rear doors are deactivated.

The safety control symbol  lights up in yellow if the buttons on the rear doors are switched off.

#### Convenience open/close function



The electric windows can be opened or closed from outside using the vehicle key:

*Convenience opening:*

- Press and hold the  button on the remote control key until all the windows and the sunroof have reached the desired position.

- **OR:** First unlock the vehicle using the  button on the remote control key and then keep the key in the driver door lock until all the windows and the sunroof have reached the required position.

*Convenience closing:*

- Press and hold button  on the remote control key until all the windows and the sunroof are closed .
- **OR:** Keep the key in the driver door in the "lock" position until all the windows and the sunroof are closed.

During convenience closing, first the windows and then the sliding sunroof will be closed.

In the infotainment system different settings can be adjusted using the function button  > **Settings** > **Opening and closing** > **Window operation** > **Convenience opening**.

#### One-touch opening and closing

The one-touch automatic opening and closing is used to open or close the windows completely. It will not be necessary to hold the button of the corresponding electric window.

**For the automatic raising function:** pull the button for the corresponding window upwards until it reaches the second position.

**For the automatic lowering function:** push the button for the corresponding window upwards until it reaches the second position.

**Stop automatic movement:** push or pull on the button of the corresponding window.

### Resetting one-touch opening and closing

The one-touch opening and closing function is not active after the vehicle battery has been disconnected or is flat and will have to be reset.

- Pull the button of the corresponding window and hold it for one second in this position.
- Release the button and pull upwards and hold again. The one-touch function is now ready for operation.

The automatic one-touch electric windows can be reinitialised individually or several at a time.

### WARNING

Observe the safety warnings >>>  in Introduction on page 99.

- Incorrect use of the electric windows can result in injury.
- Never close the rear lid without observing and ensuring it is clear, to do otherwise could cause serious injury to you and third parties. Make sure that no one is in the path of a window.

- If the ignition is switched on, the electric equipment could be activated with risk of injury, for example, in the electric windows.

- The doors can be locked using the remote control key. This could become an obstacle for assistance in an emergency situation.

- Therefore always take the key with you when you leave the vehicle.

- The electric windows will work until the ignition has been switched off and one of the front doors has been opened.

- If necessary, use the safety switch to disable the rear electric windows. Make sure that they have been disabled.

- For safety reasons, you should only use the remote control open and close functions within about 2 metres of the vehicle. To avoid injuries, always keep an eye on the windows when pressing the button to close them. The windows stop moving as soon as the button is released.

### Note

If the window is not able to close because it is stiff or because of an obstruction, the window will automatically open again >>> page 107. If this happens, check why the window could not be closed before attempting to close it again.

## Window anti-trap function

The roll-back function reduces the risk of injury when the electric windows close.

- If a window is obstructed when closing automatically, the window stops at this point and lowers immediately >>> .
- Next, check why the window does not close before attempting it again.
- If you try within the following 10 seconds and the window closes again with difficulty or there is an obstruction, the automatic closing will stop working for 10 seconds.
- If the window is still obstructed, the window will stop at this point.
- If there is no obvious reason why the window cannot be closed, try to close it again by pulling the tab within ten seconds. The window closes with maximum force. **The roll-back function is now deactivated.**
- If more than 10 seconds pass, the window will open fully when you operate one of the buttons. One-touch closing is reactivated.

### WARNING

Observe the safety warnings >>>  in Electrically opening and closing the windows on page 107.

- The roll-back function does not prevent fingers or other parts of the body getting

»

pinched against the window frame. Risk of accident.

## Sunroof

### Introduction

The sunroof consists of two glass parts. The rear part is fixed and cannot be opened. It also has a sun blind.

The sunroof only works when the ignition is switched on. Once the ignition has been switched off, you can still open or close the sunroof for a few minutes provided the driver door and the front passenger door are not opened.

### ⚠ WARNING

If the sunroof is used negligently or without paying due attention, it can cause serious injury.

- Open or close the sunroof and the sun blind only when no one is in their path of movement.
- Never leave any key inside the vehicle when exiting.
- Never leave a child or any other person who may need help in the vehicle, especially if they have access to the vehicle key. If using they key unattended, they could lock

the vehicle, start the engine, switch on the ignition and activate the sunroof.

- After switching off, it is still possible to open or close the sunroof during a short space of time provided that neither the driver nor passenger door is opened.

### ⚠ CAUTION

- To prevent damage, during winter temperatures remove any ice or snow that might be on the car roof before opening the sunroof or adjusting the tilt position.
- Before leaving the vehicle or in case of rainfall, always close the sunroof. With the sunroof open or in a tilted position, water can enter the interior and can cause considerable damage to the electrical system. As a result, other damage can occur in the vehicle.

### i Note

- Leaves and other loose objects that accumulate on the sunroof rails should be regularly cleaned away either by hand or with a vacuum.
- If the sunroof does not work correctly, the anti-trap function will not work either. Contact a specialised workshop.

### Opening and closing the sunroof

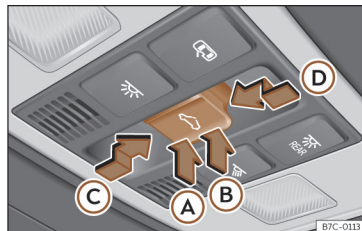



Fig. 84 On the interior roof lining: sunroof button.

The sun blind automatically opens along with the sunroof if completely closed or if in front of the sunroof. The sun blind remains in the previous position and does not automatically close with the sunroof. The sun blind can only be closed completely once the sunroof has been closed.

The  button  Fig. 84 has two levels. The first level switches the sunroof to the tilted position, opening or closing it fully or partially.

On the second level, the sunroof automatically moves to the corresponding final position after briefly pressing the button. Activating the button again stops the automatic function.

### Adjusting the tilt position of the sunroof

- Press the rear part of the button **(B)** to the first level.
- Automatic function: briefly press the rear part of button **(B)** to the second level.

### Closing the sunroof from a tilted position

- Press the front part of the button **(A)** to the first level.
- Automatic function: briefly press the front part of the button **(A)** to the second level.

### Stopping the automatic operation by adjusting the tilted position of the sunroof or by closing the sunroof

- Press button **(A)** or **(B)** again.

### Opening the sunroof

- Press button **(C)** backwards to the first level.
- Automatic function to the comfort position: briefly press button **(C)** backwards to the second level.

### Closing the sunroof

- Press button **(D)** forwards to the first level.
- Automatic function: briefly press button **(D)** forwards to the second level.

### Stopping the automatic operation during the opening or closing

- Press button **(C)** or **(D)** again.

### Opening and closing the sunshade blind

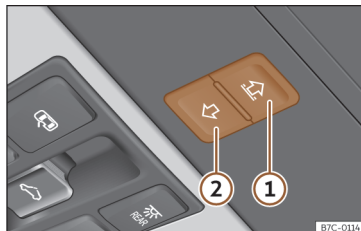

**Fig. 85** On the interior roof lining: sunshade blind buttons.

The electrical sun blind works when the ignition is switched on.

When the sunroof is in its most tilted position, the sun blind automatically goes into a ventilation position. The sun blind remains in this position also with the sunroof closed.

Buttons **>>> Fig. 85 (1)** and **(2)** have two levels. The first level opens or closes the sun blind fully or partially.

By briefly pressing the button to the second level, the sun blind automatically moves to

the corresponding final position. Activating the button again stops the automatic function.

Once the ignition has been switched off, you can still open or close the sun blind for a few minutes provided the driver door and the front passenger door are not opened.

### Opening the sun blind

- Press button **(1)** to the first level.
- Automatic function: briefly press button **(1)** to the second level.

### Closing the sun blind

- Press button **(2)** to the first level.
- Automatic function: briefly press button **(2)** to the second level.

### Stopping the automatic operation during the opening or closing

- Press button **(1)** or **(2)** again.

#### **i** Note

**When the sunroof is open, the electric sun blind can only be closed to the front edge of the sunroof.**

### Convenience function to open or close the sunroof

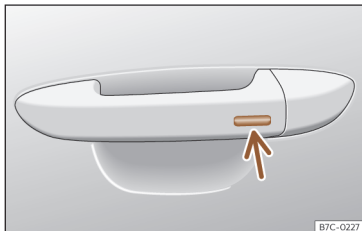

**Fig. 86** Door handle: sensor surface.

The sunroof can be opened and closed with the convenience function, just like the windows.

### Using the door lock

- Hold the key in the door lock of the driver door in either the unlocking or locking position to open or close the roof in the tilted position. Release the key to interrupt this function.

### Using the remote control

- Keep the locking or unlocking button pressed to open or close the roof. If you release the button is the opening or closing will stop.

### Using the Keyless Access system (only closing)

- Press and hold the locking sensor surface >>> **Fig. 86** (arrow) on the door handle to close the sunroof. If you release the sensor surface, the closing movement stops.

### Anti-trap function of the panoramic sunroof and sunshade

The anti-trap function can reduce the risk of injury when closing the sunroof and the sun blind >>> ⚠. If the sunroof or sun blind encounter resistance or an obstacle when closing, they reopen immediately.

- Check why the sunroof or sun blind do not close.
- Try to close the sunroof or sun blind again.
- If the sunroof or sun blind cannot be closed due to an obstacle or some resistance, it stops at the corresponding position and then opens. For automatic closing, a new closing attempt might take place.
- If the sunroof or sun blind is still unable to close, close it without the anti-trap function.

### Closing the sunroof or sun blind without the anti-trap function

- *Sunroof*: within approximately 5 seconds of having activated the roll-back function, press

the button >>> **Fig. 84** to the second level in the direction of arrow >>> **Fig. 84** until the sunroof closes completely.

- *Sun blind*: within approximately 5 seconds of having activated the anti-trap function, press button >>> **Fig. 85** until the sun blind closes completely.
- **The sunroof or sun blind close without the anti-trap function intervening!**
- If the sunroof or sun blind will still not close, visit a specialised workshop.

### WARNING

**Closing the sunroof or sun blind without the anti-trap function can cause serious injuries.**

- Always be careful when closing the sunroof and sun blind.
- No person should ever remain in the way of the sunroof or sun blind, especially when closing without the anti-trap function.
- The anti-trap function does not prevent fingers or other parts of the body from becoming trapped against the roof frame and injuries occurring.



## Lights

### Vehicle lighting

#### Control lamps

##### It lights up

Driving light totally or partially faulty.

Fault in the cornering light system.

##### It lights up

Rear fog light switched on»» page 113 .

##### It lights up

Left or right turn signal.  
The control lamp flashes twice as fast when a turn signal is faulty.

Hazard warning lights on»» page 116 .

##### It lights up

Trailer turn signals

##### It lights up

Main beam on or flasher on»» page 113 .

##### It lights up

The Light Assist system is on»» page 114 .

Several warning and control lamps light up for a few seconds when the ignition is switched on, signalling that the function is being verified. They will switch off after a few seconds.

#### WARNING

Observe the safety warnings »»  in Control and warning lamps on page 81.



#### Headlight switch



**Fig. 87** Dash panel: lights control.

- Turn the switch to the required position »» **Fig. 87**.

Symbol	Ignition switched off	Ignition is switched on
0	Fog lights, dipped beam and side lights off.	Daylight running lights switched on.

Symbol	Ignition switched off	Ignition is switched on
AUTO	The “Coming home”, “Leaving home” and Welcome lights may be switched on.	Automatic control of dipped beam and daytime running light.
	Side light on.	Daylight running lights switched on.
	Dipped beam headlight off	Dipped beam switched on.

The driver is personally responsible for the correct use and adjustment of the lights in all situations.

#### Automatic dipped beam headlight control AUTO

The automatic dipped beam control is merely intended as an aid and is not able to recognise all driving situations.

When the light switch is in position **AUTO**, the vehicle lights and the instrument panel and switch lighting switch on automatically in the following situations »» :

- The photo sensor detects *darkness*, for example, when driving through a tunnel. They switch off when adequate lighting is detected. »»

- The rain sensor detects rain and activates the wipers. They switch off when the wipers have not been activated for a few minutes.

### Daytime running lights

The daytime running lights consist of individual lights, integrated in the front headlights. These lights come on when the daytime running lights are switched on. On vehicles equipped with LED tail lights, the rear side light is switched on as well >>> .

The daytime running lights turn on every time the ignition is switched on, if the switch is in position **0** or **AUTO**, according to the level of exterior lighting.

When the light switch is in position **AUTO**, a light sensor automatically switches dipped beam on and off (including the control and instrument lighting) or the daytime running lights depending on the level of exterior lighting.

### Motorway light



The function is connected and disconnected via the corresponding Infotainment system menu.

- **Activation:** when going above 110 km/h (68 mph) for more than 10 seconds, the dipped beam raises slightly to increase the driver's visibility distance.

- **Deactivation:** when reducing the speed of the vehicle below 100 km/h (62 mph), the dipped beam immediately returns to its normal position.

### Audible warnings to advise the driver that the lights have not been switched off

If the ignition is not connected and the driver door is open, an audible warning signal is heard in the following cases: this will remind you to turn the light off.

- When the parking light is on >>> page 113.
- When the light switch is in position  or .

#### WARNING

If the road is not well lit and other road users cannot see the vehicle well enough or at all, accidents may occur.

- The automatic dipped beam control (**AUTO**) only switches on the dipped beam when there are changes in light conditions but not, for example, when it is foggy.

#### WARNING

The side lights or daytime running lights are not bright enough to illuminate the road ahead and to ensure that other road users are able to see you.

- Always use your dipped beam head lights if it is raining or if visibility is poor.

- Never drive with daytime lights if the road is not well lit due to weather or lighting conditions.

- On vehicles with rear lights with bulbs, when activating the daytime running light the rear lights are not switched on. A vehicle which does not have the rear lights on may not be visible to other drivers in the darkness, in the case of heavy rain or in conditions of poor visibility.

#### WARNING

If the headlights are set too high and not used correctly, there is a risk of dazzling or distracting other road users. This could result in a serious accident.

- Always make sure that the headlights are correctly adjusted.

#### Note

- The legal requirements regarding the use of vehicle lights in each country must be observed.
- The dipped beam headlights will only work with the ignition on. The side lights come on automatically when the ignition is turned off.
- The rear fog light can dazzle drivers behind you. You should use the rear fog light only when visibility is very poor.

## Fog lights



Fig. 88 Dash panel: lights control.

The warning lamps  $\otimes$  or  $\otimes$  also show, on the light switch or instrument panel, when the front fog lights are on.

- **Turning on the front fog lights  $\otimes$ :** pull the light switch out from its first click position  $\ggg$  Fig. 88 ①, from positions  $\Rightarrow$ ,  $\Rightarrow$  or **AUTO**.
- **Turning on the rear fog light  $\otimes$ :** pull the light switch fully out ② from position  $\Rightarrow$ ,  $\Rightarrow$  or **AUTO**.
- To switch off the fog lights, press the light switch or turn it to position **0**.

### Note

The rear fog light can dazzle drivers behind you. You should use the rear fog light only when visibility is very poor.

## Turn signal and main beam lever

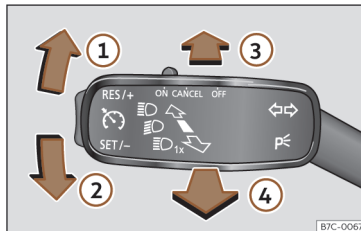

Fig. 89 Turn signal and main beam lever.

Move the lever to the required position:

- ① Right turn light or right-hand parking light (ignition switched off).
- ② Left turn light or left-hand parking light (ignition switched off).
- ③ Turning main beam headlights on: control lamp  $\Rightarrow$  lit up on the instrument panel.
- ④ The headlight flasher comes on while we pull the lever. Control lamp  $\Rightarrow$  lit up.

Place the lever in rest position to turn off the corresponding function.

### Convenience turn signals

When the ignition is switched on, move the lever as far as possible upwards or down-

wards and release the lever. The turn signal will flash three times.

The convenience turn signals are activated and deactivated in the infotainment system using the function button  $\ggg$  **Settings**  $\ggg$  **Light**  $\ggg$  **Light assistance**  $\ggg$  **Convenience turn signals**  $\ggg$  page 86.

In vehicles that do not have the corresponding menu, this function can be deactivated in a specialised workshop.

### Parking light $\Rightarrow$

The parking lights will only work with the ignition off. If said light is on, an audible warning will sound while the driver door is open.

- Switch the ignition off.
- Move the turn signal lever up or down.

When the parking light is switched on, the front side light and the tail light on the corresponding side of the vehicle turn on.

### Parking light on both sides

- Switch the ignition off.
- Place the light switch in position  $\Rightarrow$ .
- Lock the vehicle from the outside.

In doing so, only the side lights of both headlights light up, and additionally the tail lights will do so partially.  $\ggg$

### WARNING

Improper or lack of use of the turn signals, or forgetting to deactivate them can confuse other road users. This could result in a serious accident.

- Always give warning when you are going to change lane, overtake or when turning, activating the turn signal in good time.
- As soon as you have finished changing lane, overtaking or turning, switch the turn signal off.

### WARNING

Incorrect use of the headlights may cause accidents and serious injury, as the main beam may distract or dazzle other drivers.

### Note

- If the convenience turn signals are operating (three flashes) and the other convenience turn signals are switched on, the active part stops flashing and only flashes once in the new part selected.
- The turn signal only works when the ignition is switched on. The hazard warning lights also work when the ignition is switched off.
- If a trailer turn signal malfunctions, the control lamp will stop flashing (trailer turn signals) and the vehicle turn signal will flash at double speed.

- The **main beam headlights** can only be switched on if the dipped beam headlights are already on.

- In cold or damp weather conditions, the headlights, tail lights and turn signals may mist up inside temporarily. This is normal and in no way effects the useful life of the vehicle lighting system.

- The parking light does not activate automatically if the left- or right-hand turn signal is left on and the ignition is disconnected.

### Main beam assist (Light Assist)

The main beam assist automatically prevents glare from vehicles moving in the opposite direction or ahead in the same direction. In addition, the main beam assist detects illuminated areas and disconnects the main beam headlight when passing, e.g. by populated areas.

Within its limitations, the assist system automatically connects or disconnects the main beam headlight depending on the environmental and traffic conditions, as well as the speed >>> .

#### Switching the main beam assist on

- Turn on the ignition and turn the light switch to the position **AUTO**.

- From the base position, press the turn signal and main beam headlights lever forwards >>> **Fig. 89 ③**

When the main beam assistant is on, the  indicator lamp lights up on the instrument cluster display.

When the main beam light is on, the  main beam indicator lamp lights up on the instrument cluster.

#### Switching the main beam assist off

- Turn the light switch to a position other than **AUTO** >>> page 111.

- **OR:** while the main beam is on, pull the turn signal light and main beam headlights lever forwards >>> **Fig. 89 ④**.

- **OR:** if the main beam assistant is on, but the main beam **does not** turn on, press the turn signal and main beam lever forwards to turn the main beam on manually. Pull the turn signal and main beam lever back to switch off the main beam manually, if necessary.

- **OR:** switch off the ignition.

#### System limitations

In the following cases, the main beam headlight must be switched off manually because the main beam assist will not disconnect it on time or disconnect it at all:

- On roads with insufficient lighting with very reflective signs
- If road users are insufficiently lit up, e.g. pedestrians or cyclists.
- On closed curves, when the traffic in the opposite direction is partially hidden, on pronounced slopes or inclinations.
- On roads with traffic in the opposite direction and with a central reservation barrier where the driver can see over it e.g. lorry drivers.
- In the event of fog, snow or heavy rain
- In the event of dust or sand storms
- If the windscreen is damaged in the camera's field of vision.
- If the camera's field of vision is misted up, dirty or covered by a sticker, snow or ice.
- If the camera is damaged or if the power supply has been cut off.

### WARNING

The convenience features of the main beam assist should not encourage the taking of risks. The system is not a replacement for driver concentration.

- You are always in control of the main beam and adapting it to the light, visibility and traffic conditions.
- It is possible that the main beam headlight control does not recognise all driving

situations and is limited under certain circumstances.

- When the field of vision of the camera is dirty, covered or damaged, operation of the main beam control may be affected. This also applies when changes are made to the vehicle lighting system, for example, if additional headlights are installed.

### CAUTION

To avoid affecting the operation of the system, take the following points into consideration:

- Clean the field of vision of the camera regularly and make sure it is free of snow and ice.
- Do not cover the field of vision of the camera.
- Check that the windscreen is not damaged in the area of the field of vision of the camera.

### Note

- The headlight flasher can be turned on and off manually at any time with the turn signal and main beam lever»» page 113.
- If there are objects that radiate light in the camera's area of influence, e.g. a portable navigation system, this may affect the operation of the main beam assist system.

## Fog lights with cornering light function

The *cornering* light function is an additional function to the dipped beam headlights to improve lighting of the side of the road when taking a sharp turn at low speed.

The *cornering* light function works when the dipped beam headlights are already on and it is activated when driving at speeds below approximately 40 km/h (25 mph).

- If the steering wheel is turned or the turn signal is switched on, the front fog light gradually turns on. After the turn, the *cornering* light function is gradually switched off.
- When engaging reverse gear, both front fog lights turn on.

## “Coming home” and “Leaving home” function

The “Coming home” and “Leaving home” function lights up the vehicle's immediate proximity when getting into and out of it in the dark. When switched on, the front position and dipped beam lights, tail lights and license plate light come on.

The “Leaving Home” is controlled by a photosensor. »

In the vehicle settings menu of the infotainment system you can adjust the duration of the light switch-off delay, and activate and deactivate the function.

### Activating the “Coming Home” function

*For vehicles with light and rain sensors.*

- Switch off the engine and remove the key from the ignition with the light switch in position **AUTO**»» page 111.
- The automatic “Coming Home” function is only active when the light sensor detects darkness.

*For vehicles without light and rain sensors.*

- Switch the ignition off.
- Activate the headlight flashers for *approximately 1 second*.

When the driver door is opened, the “Coming Home” lighting comes on. The *headlight turning off time* counts from when the last door or rear lid are closed.

### The “Coming Home” lighting turns off in the following cases:

- Automatically, once the headlight turning off time has elapsed.
- Automatically, when a vehicle door or the rear lid is still open 30 seconds after starting the engine.

- When the rotary light switch is turned to position **0**»» page 111.
- With the ignition is switched on.

### Activating the “Leaving Home” function

- Unlock the vehicle using the remote control.
- The “Leaving Home” function is only activated when the light switch is in position **AUTO** and the light sensor detects darkness.

### The “Leaving Home” lighting switches off in the following cases:

- Automatically, when the “Leaving Home” switch-on time ends (default 30 sec).
- When the vehicle is locked using the remote control.
- When the light switch is turned to position **0**.
- With the ignition is switched on.

### Welcome light

The welcome light is a light located on the exterior mirrors, focused on the ground, which activates or deactivates if the light switch is in the **AUTO** position and the “Coming Home” or “Leaving Home” function is turned on or off.

### Note

To activate the “Coming Home” and “Leaving Home” function, the rotary light switch must be in position **AUTO** and the light sensor must detect darkness.

## Hazard warning lights



**Fig. 90** Dash panel: hazard warning lights switch

The hazard warning lights are used to draw the attention of other road users to your vehicle in emergencies.

If your vehicle breaks down:

1. Park your vehicle at a safe distance from moving traffic.
2. Press the button to switch on the hazard warning lights »» .
3. Switch the ignition off.

4. Apply the electronic parking brake.
5. Move the selector lever to position P.
6. Use the warning triangle to draw the attention of other road users to your vehicle.
7. Always take the vehicle key with you when you leave the vehicle.

All turn signals flash simultaneously when the hazard warning lights are switched on. The two turn signal lamps  $\leftrightarrow$  and the turn signal lamp in the switch  $\triangle$  will flash at the same time. The simultaneous hazard warning lights also work when the ignition is switched off.

### Emergency braking warning

If the vehicle brakes suddenly and continuously at a speed of more than 80 km/h (50 mph), the brake light flashes several times per second to warn the vehicles driving behind. If you continue braking, the hazard warning lights will come on automatically when the vehicle comes to a standstill. They switch off automatically when the vehicle starts to move again.

#### WARNING

- The risk of an accident increases if your vehicle breaks down. Always use the hazard warning lights and a warning triangle to

draw the attention of other road users to your stationary vehicle.

- Due to the high temperatures that the catalytic converter can reach, never park in an area where the catalytic converter could come into contact with highly inflammable materials, for example dry grass or spilled petrol. This could start a fire.

#### Note

- The battery will run down if the hazard warning lights are left on for a long time, even if the ignition is switched off.
- The use of the hazard warning lights described here is subject to the relevant statutory requirements.

### Dynamic headlight range control

The headlight range is automatically adjusted according to the vehicle load status when they are switched on.

#### WARNING

Heavy objects in the vehicle may mean that the headlights dazzle and distract other drivers. This could result in a serious accident.

- Adjust the light beam to the vehicle load status so that it does not blind other drivers.

### Driving abroad

The light beam of the dipped beam lights is asymmetric: the side of the road on which you are driving is lit more intensely.

When a car that is manufactured in a country that drives on the right travels to a country that drives on the left (or vice versa), it is normally necessary to cover part of the headlight bulbs with stickers or to change the adjustment of the headlights to avoid dazzling other drivers.

In such cases, the regulations specify certain light values that must be complied with for designated points of the light distribution. This is known as "Tourist light".

The light distribution of the headlights allows the specific "tourist light" values to be met without the need for stickers or changes being made to the settings.

#### Note

"Tourist light" is only allowed temporarily. If you are planning a long stay in a country that drives on the other side, you should take the vehicle to an Authorised Technical Service to change the headlights.

## Interior lights

### Lighting of the instrument panel, displays and switches

Depending on the model, the lighting of the instrument cluster and controls can be adjusted in the infotainment system, using the **Settings** button»» page 86.

In certain cases, when the engine is running and the lights are not switched on; e.g., passing through a tunnel without having activated the **AUTO** function, a **Switch on the Lights** warning will appear on the instrument panel.

### Interior and reading lights<sup>1)</sup>

#### Glove compartment and luggage compartment lighting

When opening and closing the glove compartment on the front passenger side and the rear lid, the respective light will automatically switch on and off.

<sup>1)</sup> Depending on the features fitted in the vehicle, LEDs can be used for the following interior lights: front vanity mirror light, rear vanity mirror light, footwell light, sun blind and glove compartment light.

#### Footwell lighting

The lights in the footwell area below the dash (driver and front passenger sides) will switch on when the doors are opened and will decrease in intensity while driving. This intensity can be changed through the infotainment system menu (key **Settings** > **Light** > **Interior Lighting**)»» page 86).

#### Background lighting

The background lighting lights up the area of the centre console, the footwell area and, depending on the version, the front door panels.

The background lighting in the door panels may change colour. The intensity and colour can be adjusted through the infotainment system menu (key **Settings** > **Background Lighting**)»» page 86).

#### Note

The reading lights go out when the vehicle is closed and locked or after a few minutes of turning the ignition off. This prevents the battery from discharging.

## Visibility

### Windscreen wiper and rear window wiper systems

#### Window washer lever

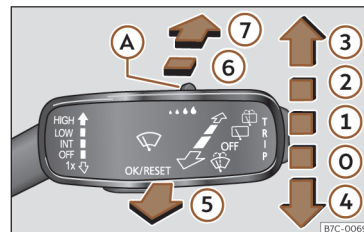



**Fig. 91** Operating the windscreen wiper and rear wiper.

#### More the lever to the required position:

**OFF** Windscreen wipers off.



## Move the lever to the required position:

①	<b>INT</b>	Wiper intervals. Use control»» Fig. 91 (A) to set the interval (vehicles without rain sensor), or the sensitivity of the rain sensor.
②	<b>LOW</b>	Slow sweep adjustable by using control »» Fig. 91 (A).
③	<b>HIGH</b>	Fast sweep adjustable by using control »» Fig. 91 (A).
④	<b>1x</b>	Short wipe. Brief press, short clean. Hold the lever down for more time to increase the wipe frequency.
⑤		Windscreen washer. The windscreen washer function is activated by pushing the lever towards the steering wheel, and the wipers operate simultaneously.
⑥		Interval wipe for rear window. The wiper will wipe the window approximately every six seconds.
⑦		The rear window wash function is activated by pressing the lever, and the rear wiper starts simultaneously.

## WARNING

In cold conditions you should not use the wash/wipe system unless you have warmed the windscreen with the heating and ventilation system. The windscreen washer fluid could otherwise freeze on the windscreen and obscure your view of the road.

## CAUTION

If the ignition is switched off while the windscreen wipers are switched on, they complete their wipe and return to the rest position. When the ignition is switched back on, the windscreen wiper will continue to operate at the same wiping level. Ice, snow and other obstacles on the windscreen may damage the wiper and the windscreen wiper motor.

- If necessary, remove snow and ice from the windscreen wipers before starting your journey.
- Do not switch on the windscreen wipers if the windscreen is dry. Cleaning with the windscreen wipers while dry can cause damage.
- In icy conditions, always check that the wiper blades are not frozen to the glass before using the wipers. In cold weather, it may help to leave the vehicle parked with the wipers in service position»» page 48.

## Note

- The windscreen and window wipers only function when the ignition is switched on and the bonnet or rear lid, respectively, are closed.
- The interval wipe speed varies according to the vehicle speed. The faster the vehicle is moving, the more often the windscreen is cleaned.

- The rear wiper is automatically switched on when the windscreen wiper is on and the car is in reverse gear.

## Wiper functions

### Windscreen wipers performance in different situations

- If you stop the vehicle with the windscreen wiper in position 1 or 2, it will automatically change to a lower position speed. The set speed will be resumed when the vehicle pulls away.
- The air conditioner comes on for approximately 30 seconds in air recirculation mode when the windscreen washer is activated,  to prevent the smell of the windscreen washer fluid entering the inside the vehicle.
- When wiping at intervals, the intervals vary according to the speed. The higher the vehicle speed the shorter the intervals.

### Heated windscreen washer jets

The heating only thaws the frozen jets, it does not thaw the water in the washer hoses. When the ignition is switched on the heated windscreen washer jets automatically adjust the heat depending on the ambient temperature. »

**Note**

- The wiper will try to wipe away any obstacles that are on the windscreen. The wiper will stop moving if the obstacle blocks its path. Remove the obstacle and switch the wiper back on again.
- The windscreen will be wiped again approximately 5 seconds after the windscreen washer has been activated, provided the vehicle is moving ("drip" function). If you activate the wipers less than 3 seconds after the "drip" function, a new wash sequence will begin without performing the last wipe. For the "drip" function to work again, you have to turn the ignition off and then on again.

**Rain sensor**

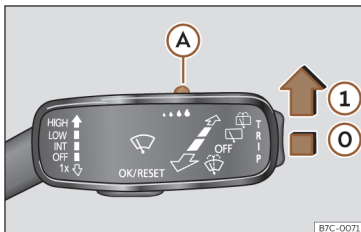

**Fig. 92** Wiper lever: adjust the rain sensor

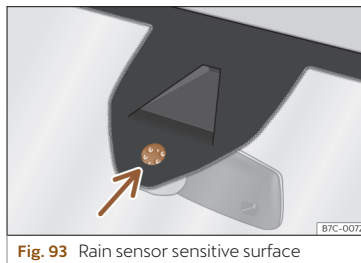

**Fig. 93** Rain sensor sensitive surface

The rain sensor controls the frequency of the windscreen wiper intervals, depending on the amount of rain >>> **Δ**. The sensitivity of the rain sensor can be adjusted manually. Manual wipe >>> page 118 .

Move the lever to the required position

>>> **Fig. 92:**

- ⊖ Rain sensor off.
- ① Rain sensor on; automatic wipe if necessary.
- Ⓐ Setting sensitivity level of rain sensor
  - Set control to the right: high sensitivity.
  - Set control to the left: low sensitivity.

When the ignition is switched off and then back on, the rain sensor remains active and starts operating again when the windscreen wipers are in position ① and the vehicle is travelling at more than 16 km/h (10 mph).

**Modified behaviour of the rain sensor**

Possible causes of faults and mistaken readings on the sensitive surface >>> **Fig. 93** of the rain sensor include:

- Damaged wipers: a film of water on the damaged blades may lengthen the activation time, reduce the washing intervals or result in a fast and continuous wipe.
- Insects: insects on the sensor may trigger the windscreen wiper.
- Salt on the road: in winter, salt spread on the roads may cause an excessively long wipe when the windscreen is almost dry.
- Dirt: dry dust, wax, coating on glass (Lotus effect) or traces of detergent (car wash) may reduce the effectiveness of the rain sensor or make it react more slowly, later or not at all.
- Windscreen crack: the impact of a stone will trigger a single wipe cycle with the rain sensor on. Next the rain sensor detects the reduction in the sensitive surface area and adapts accordingly. The behaviour of the sensor will vary with the size of the damage caused by the stone.

**WARNING**

The rain sensor may not detect enough rain to switch on the wipers.

- If necessary, switch on the wipers manually when water on the windscreen obstructs visibility.

## Note

- Regularly clean the sensitive surface of the rain sensor >>> Fig. 93 (arrow) and check for possible damage to the wiper blades.
- To remove wax and coatings, we recommend a window cleaner containing alcohol.
- Do not put stickers on the windscreen in front of the rain sensor. This may cause sensor disruption or faults.

## Mirrors

### Interior mirror anti-dazzle function

#### Rear view mirror with automatic anti-dazzle function

The anti-dazzle function is activated every time the ignition is switched on.

When the anti-dazzle function is enabled, the interior rear vision mirror will darken **automatically** according to the amount of light it receives. The anti-dazzle function is cancelled if reverse gear is engaged.

## WARNING

In the event that an automatic anti-dazzle rear vision mirror breaks, an electrolyte fluid may leak. This could cause irritation to the skin, eyes and respiratory organs. If you come into contact with this liquid, it must be rinsed with large quantities of water. If necessary, get medical help.

## CAUTION

In the event that an automatic anti-dazzle rear vision mirror breaks, an electrolyte fluid may leak. This liquid attacks plastic surfaces. Clean it with a wet sponge as soon as possible.

## Note

- If the light falling on the interior mirror is obstructed (e.g. with the sun blind), the anti-dazzle mirror with automatic adjustment will not operate perfectly.
- When the interior lights are on or reverse gear engaged, the mirrors do not darken with automatic adjustment for anti-dazzle position.
- If you have to stick any type of sticker on the windscreen, do not do so in front of the sensors. Doing so could prevent the anti-dazzle function from working well or even from working at all.

## Adjusting the exterior mirrors

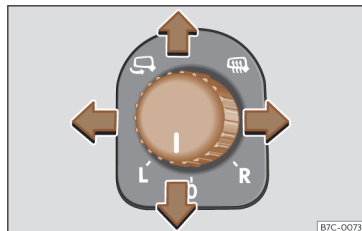

Fig. 94 Detail of the driver's door: control for the exterior mirror.

Turn the control to the corresponding position:

**L/R** Turning the knob to the desired position, adjust the mirrors on the driver side (L, left) and the passenger side (R, right) to the direction desired.

Depending on the equipment fitted on the vehicle, the mirrors may be heated according to the outside temperature.

Folding in mirrors.

### Synchronized regulation of the exterior mirrors

In the infotainment system, using the function button > **Settings** > **Mirrors and wipers** > **Mirrors**, the exterior rear view »

mirrors can be selected to adjust in a synchronised manner.

- Turn the knob to position **L**<sup>1)</sup>.
- Adjust the left-hand exterior mirror. The right exterior mirror will be adjusted at the same time (synchronised).
- If necessary, correct the right-hand rear-view mirror: rotate the control to position **R**<sup>1)</sup>.

### Tilt function for front passenger exterior mirror

When parking backwards, and in order to be able to see the kerb, the passenger side mirror can be automatically tilted towards the passenger to provide a better view of the kerb. The control must be in the position **R**<sup>1)</sup> for this feature to be operational.

The mirror returns to its original position as soon as you drive forward at over 15 km/h (9 mph) or switch off the ignition. It also returns to its original position if the position of the control is adjusted.

### Storing the rear view mirror settings for the tilt function

- Switch the ignition on.
- In the infotainment system, select  > **Settings** > **Mirrors and wipers** > **Mir-**

**rors** > **Lower in reverse gear**  
>>> page 82.

- Select the **R**<sup>1)</sup> position on the control.
- Select reverse gear.
- Adjust the front passenger exterior mirror so that you can see, for example, the kerb area well.
- Release the reverse gear.
- The adjusted position for the rear view mirror is stored.

### Fold the rearview mirrors when locking the vehicle

In the infotainment system, using the function button  > **Settings** > **Mirrors and wipers** > **Mirrors**, the exterior mirrors can be selected to fold in when the vehicle is parked and locked>>> page 82.

When the vehicle is locked with the remote control, the exterior mirrors are retracted automatically. When the vehicle is opened with the remote control, the exterior mirrors are deployed automatically.

### WARNING

Convex or wide-angle exterior mirrors give a larger field of vision. However, they make objects look smaller and further away than

they really are. If you use these mirrors to estimate the distance to vehicles behind you when changing lane, you could misjudge the distance. Risk of accident!

### WARNING

Fold and unfold the exterior mirror, taking care to avoid injuries.

- Only fold or unfold the exterior mirror when there is no-one in the way of the mirror.
- When moving the mirror, take care not to trap fingers between the mirror and the mirror bracket.

### CAUTION

- If for any reason (e.g. a bump when manoeuvring) one of the rear view mirrors is knocked out of position, the mirrors must first be fully retracted with the electric control. The rear view mirror must not be placed by hand in the starting position, as the folding mechanism can be damaged.
- Before washing the vehicle in an automatic car wash, please make sure to fold the exterior mirrors in to prevent them from being damaged. Electrically retractable exterior mirrors must not be folded in or

<sup>1)</sup> Regulation in right-hand drive vehicles is symmetrical.

out by hand, always use the electrical power control.

#### Note

- If the electrical adjustment should fail to operate, both of the mirrors can be adjusted by hand by lightly pressing the edge of the mirror glass.
- The fold-in function on the exterior mirrors will not activate at speeds over 40 km/h (25 mph).

## Sun protection

### sun blind

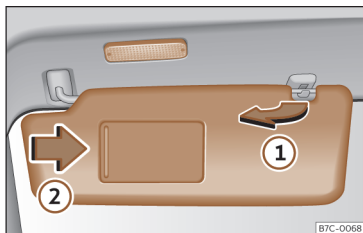

Fig. 95 Sun visor

### Options for adjusting driver and front passenger sun visors

- Lower the sun visor towards the wind-screen.
- The sun visor can be pulled out of its mounting and turned towards the door >>> Fig. 95 ①.
- Swing the sun visor towards the door, longitudinally backwards.

There is a vanity mirror on the sun visor, with a cover. When the cover is opened ② a light comes on.

The lamp goes out when the vanity mirror cover is closed or the sun visor is pushed back up.

#### WARNING

Folded sun blinds can reduce visibility.

- Always store sun blinds and visors in their housing when not in use.

#### Note

The light above the sun visor automatically switches off after a few minutes in certain conditions. This prevents the battery from discharging.

## Seats and headrests

### Adjusting seats

#### Manual adjustment of the front seats

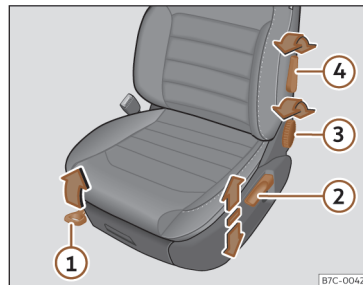

Fig. 96 Front seats: manual seat settings.

- ① Forwards/backwards: pull the lever and move the seat. The seat must engage when the lever is released!
- ② Raise/lower: pull the lever up or push down (several times if necessary) from its home position.
- ③ Tilting the backrest: turn the hand wheel.
- ④ Lumbar support: move the lever until the required position is achieved.



**⚠ WARNING**

Incorrect seat adjustment may lead to accidents and severe injuries.

- Only adjust the seats when the vehicle is stationary, as the seats could move unexpectedly while the vehicle is in motion and you could lose control of the vehicle. Furthermore, an incorrect position is adopted when adjusting the seat.
- Adjust the height, position and inclination of the front seats only when their movement area is empty.
- Make sure there are no objects in that area.
- Make sure that the movement and locking areas of the seats are clean.

**⚠ WARNING**

Incorrectly using upholstery and seat covers might cause an accidental activation of the electrical seat adjustment system and make it move unexpectedly while driving. This might cause loss of control of the vehicle and thus accidents or injuries. Moreover, the electrical components of the front seats might be damaged.

- Never attach or place seat upholstery or covers on the electric controls.
- Never use upholstery or seat covers that have not been explicitly authorised for the seats of the vehicle.

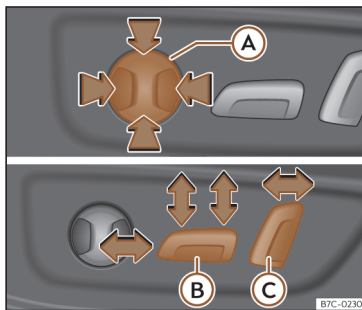
**Electric driver's seat adjustment**

**Fig. 97** Driver's seat: electric seat settings.

- A** Adjust the lumbar support: press the button according to the desired position.
- B** Seat forwards/backwards: press the button forwards/backwards.
- Seat up/down: Press the rear part of the button up/down. To adjust the angle of the seat cushion, press the front of the button up/down.
- C** Backrest further upright/further reclined: press the button forwards/backwards.

The position will be saved automatically in the CUPRA Connect Active user when the ignition is switched off.

**⚠ WARNING**

- If the electric front seats are used negligently or without paying due attention, it can cause serious injury.
- The front seats can also be electrically adjusted when the ignition is switched off. Never leave a child or any other person who may need help in the vehicle.
- In the event of an emergency, electrical adjustment can be stopped by pressing any control.

**⚠ CAUTION**

To avoid damaging the electrical components of the front seats, please refrain from kneeling on the seat or applying sharp pressure at a single point to the seat cushion and backrest.

**i Note**

- It may not be possible to electrically adjust the seat if the vehicle battery is very low.
- If the engine is started while the seats are being electrically adjusted, the adjustment will stop.
- When changing user a warning will be shown on the infotainment system's screen during the time that the seat is moving to the saved position. This movement can be stopped by pressing the stop button on the screen.

## Headrest

### Introduction

The possibilities for the adjustment and dis-assembly of the headrests are described below. Always make sure that the seats are correctly adjusted»» page 13.

All seats are equipped with a headrest. The central rear headrest is only intended for the central seat of the rear bench. Therefore, do not install it on any other seat.

### Correct adjustment of headrest

Adjust the headrest so that its upper edge is at the same level as the top of your head and under no circumstances below eye level. Keep the back of your head always as close to the headrest as possible.

### Adjusting the headrest for short people

Lower the headrest completely, even if your head is below its upper edge. In the lowest position, there may be a small distance between the headrest and the backrest.

### Adjusting the headrest for tall people

Push the headrest up as far as it will go.

### ⚠ WARNING

If travelling with the headrests removed or improperly adjusted, the risk of severe or fatal injuries in the event of accidents and sudden braking or manoeuvres increases.

- Always travel with the headrest correctly installed and adjusted.
- To decrease the risk of cervical injuries in the event of an accident, adjust the headrest correctly based on your height, always making sure that its upper edge is at the same height as the top of the head, but never below eye level. Keep the back of your head always as close to the headrest as possible and centred.
- Never adjust the headrest while the vehicle is in motion.
- Under no circumstances should the rear passengers travel while the headrests are in the non-use position.

### ⚠ CAUTION

When assembling and disassembling the headrests, do not let them meet the top lining of the vehicle, the back rest of the front seat or other parts of the vehicles. If not, this could damage the vehicle.

### Adjusting the headrests

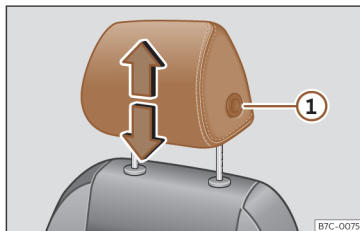

Fig. 98 Front seat: headrest adjustment.

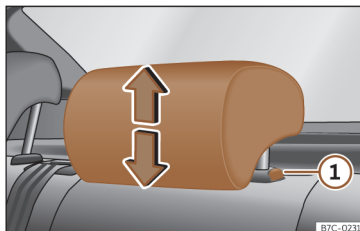

Fig. 99 Rear headrest: headrest adjustment.

### Adjusting the height of the headrests

- Grab the sides of the headrests with both hands and push upwards to the desired position. To lower it, repeat the same action, pressing the ①»» Fig. 98 »» Fig. 99 button on the side. »

- The headrest must lock correctly in one position.

## Removing and fitting the headrests

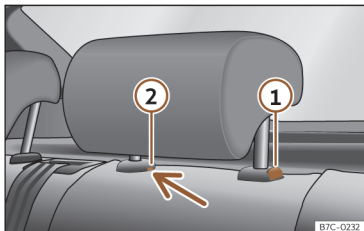

Fig. 100 Rear headrest: removal.

### Removing and fitting the front headrests

- Move the headrest upwards until it arrives to the top.
- Press the side button»» Fig. 98 ① and remove the headrest.
- To refit, insert the headrest into the holes in the backrest, pushing it down until it engages.

### Removing the rear headrests

To remove the headrest, the corresponding backrest must be partially folded forward.

- Unlock the backrest»» page 127.
- Move the headrest upwards until it arrives to the top.
- Press button»» Fig. 100 ①, while simultaneously pressing on the security hole ② with a flat screwdriver a maximum of 5 mm wide, and remove the headrest.
- Move the backrest until it engages properly »» ⚠ in Folding down and raising the rear seat backrest on page 128.

### Fitting the rear headrests

To mount the external headrests, the corresponding backrest must be partially folded forward.

- Unlock the backrest»» page 127.
- Insert the headrest bars into the guides until they perceptibly engage. It should not be possible to remove the headrest from the backrest.
- Move the backrest until it engages properly »» ⚠ in Folding down and raising the rear seat backrest on page 128.

#### ⚠ WARNING

Remove the rear headrests only when it is necessary to fit a child seat. After removing a child seat, refit the headrest immediately.

## Seat functions

### Memory function

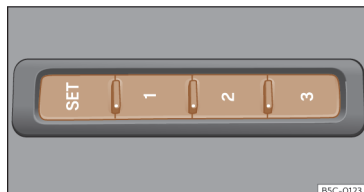

Fig. 101 On the outer side of the driver's seat: memory buttons.

### Memory buttons

The memory buttons can be used to save and turn on settings for the driver seat and the exterior mirrors.

### Save the settings of the driver seat and the exterior mirrors while driving forward

- Apply the electronic parking brake.
- Move the gearshift to the neutral position.
- Switch the ignition on.
- Adjust the driver seat and the exterior mirrors.
- Press **SET** for longer than 1 second »» Fig. 101.
- Press the memory button in which to store the settings within approx. 10 seconds. A



warning sound will confirm they have been stored.

### Storing the passenger rear view mirror settings while driving in reverse

- Apply the electronic parking brake.
- Move the gearshift to the neutral position.
- Switch the ignition on.
- Press the required memory button.
- Select reverse gear.
- Adjust the front passenger exterior mirror so that you can see, for example, the kerb area well.
- The new position of the mirror will be stored automatically and allocated to the vehicle key that was used to unlock the vehicle.

### Activating settings

- With the vehicle stopped and the ignition switched on, press and hold the corresponding memory button until the saved position is reached.
- **OR:** With the ignition switched off and the driver's door open, briefly press the corresponding button.
- The front passenger side exterior mirror automatically changes from the position stored for reversing as soon as the vehicle moves forward at a speed of at least 15 km/h (10 mph) or when the gear selection lever is

changed to a position other than R  
»» page 121.

### Initialising the seat position memory

The position memory system must be restarted if, for example, the driver seat has been changed.

Restarting deletes all memories and assignments for the seat with position memory. The memory keys can then be programmed again.

- Open the driver door and do not get into the vehicle.
- Operating the seat settings from outside the vehicle.
- Move the angle of the seat backrest completely forwards.
- Release the control to set the angle and then press again until an audible warning is heard.

#### WARNING

Adjust the memory function only when the vehicle is stationary.

#### Note

If the driver door is opened approx. 10 minutes after the vehicle was unlocked or later, the driver seat and the exterior mirrors do not move automatically.

### Folding down and raising the rear seat backrest

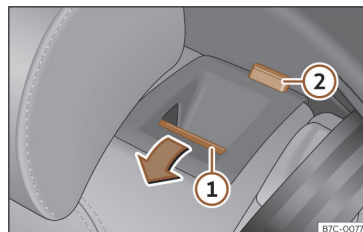

Fig. 102 Rear seat: folding the backrest.

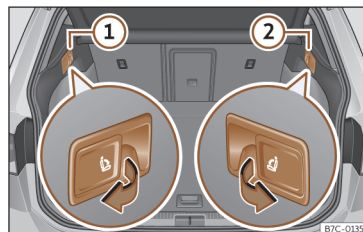

Fig. 103 In the luggage compartment: levers for remote release of the left part ① and right part ② of the rear seat backrest.

The rear seat backrest is split and each part can be lowered forward separately to extend the luggage compartment. »

### Lowering the rear seat backrest with the unlock button

- Push the headrest down as far as it will go >>> page 125.
- Pull the unlock button >>> **Fig. 102** ① forward and lift the backrest at the same time. The rear seat backrest is not engaged when the red marking of the button ② is visible.

### Folding down the backrest from the boot with the unlocking levers

- Push the headrest down as far as it will go >>> page 125.
- Open the rear lid >>> page 101.
- Pull the unlocking lever >>> **Fig. 103** of the part of the backrest to fold down.
- The corresponding part of the backrest will be unlocked or will be folded forward.
- If necessary, close the rear lid >>> page 101.

### Folding up the rear seat backrest

- Lift the backrest and press it firmly into the lock until it engages >>> ⚠.
- It should not be possible to see the red mark of the unlock button ②.
- Make sure that the seat belt is not trapped.
- The backrest must be properly engaged.
- If necessary, adjust the headrest.

### ⚠ WARNING

Serious injuries can be caused if the rear seat backrest is lowered or lifted without due care and attention.

- When folding down the rear seat, always make sure there are no people or animals in the backrest area.
- Never lower or lift the rear seat backrest while driving.
- Do not trap or damage the seat belt when raising the rear seat backrest.
- When lowering or lifting the rear seat backrest, keep your hands, fingers, feet and other body parts out of its path.
- For the rear seat belts to offer the necessary protection all the parts of the rear backrest must be properly engaged. This is particularly important in the case of the centre rear seat. If someone is seated in a seat whose backrest is not properly engaged they will be thrown forwards, along with the backrest, during an accident or a sudden driving or braking manoeuvre.
- When the rear seat backrest is lowered or is not properly engaged nobody else can travel in the corresponding seats (not even a child).

### ⓘ CAUTION

Serious damage can be caused to the vehicle and other objects if the rear seat back-

rest is lowered or lifted without due care and attention.

- Before folding the rear seat backrest forward, always adjust the front seats so that neither the headrests nor the cushions of the rear backrest can hit them.
- Before folding the rear seat backrest, always make sure there are no objects in the movement area of the backrest.

### Front centre armrest

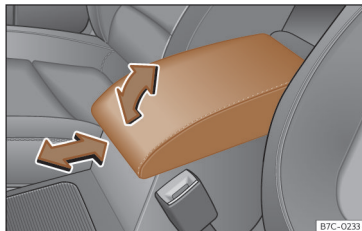

**Fig. 104** Front centre armrest

To *lift* the central armrest, lift it upwards in the direction of the arrow >>> **Fig. 104**, setting by setting.

To *lower* the armrest, first lift it to its highest position. Then lower it down.

To *move* the armrest horizontally, move it forward >>> **Fig. 104** or backward as much as

possible in the direction of the corresponding arrow.

**⚠ WARNING**

The front centre armrest may obstruct the driver's arm movements, which could cause an accident and severe injuries.

- Keep the storage compartments of the centre armrest closed at all times while the vehicle is in motion.
- Never let anyone sit on the centre armrest while the vehicle is in motion, not even a child. This position is incorrect and may cause severe injuries.

## Transport and practical equipment

### Storing objects

#### Positioning the luggage and cargo

It is possible to carry objects and luggage in the vehicle, in a trailer»» page 274 and on the roof»» page 136 . When doing so, please consider all legal provisions.

#### Placing luggage inside the vehicle safely

- Distribute the load in the vehicle as evenly as possible.
- Always place equipment and heavy objects in the boot »» ⚠.
- Position heavy items in the boot as far forward as possible.
- Take into account the maximum authorised weight per axle, as well as the maximum authorised weight of the vehicle »» page 331.
- Secure the objects to the fastening rings of the boot using appropriate chains or belts »» page 133.
- Also place small objects safely.

- Adapt tyre pressure to the load. Take into account the pressure adhesive of the tyres »» page 306.
- In vehicles equipped with tyre pressure control system, adjust to the new load status if necessary»» page 310 .

**⚠ WARNING**

Loose or unsecured objects can cause serious injury in case of sudden manoeuvring or braking or in case of an accident. Particularly if the airbag hits them when deploying and they are thrown across the inside of the vehicle. Please observe the following rules to minimise the risk of injury:

- Place all objects inside the vehicle safely.
- Secure all objects, little and large.
- Place the objects in the cabin in such a way that they can never reach the airbag deployment areas while the vehicle is in motion.
- Keep the storage compartments closed at all times while the vehicle is in motion.
- Place the objects in such a way that they never force any occupant of the vehicle to sit in an incorrect position.
- When transporting objects that take up a seat, never let anyone use that seat.
- Never leave hard, sharp or heavy objects loose in open storage compartment of the vehicle, on the cover behind the rear seat or on the dashboard.



- Remove all hard, sharp or heavy objects from the fabrics and bags inside the cabin and store them safely.

### ⚠ WARNING

The transport of heavy object changes vehicle handling and increases braking distance. Heavy objects that are not properly placed or secured may cause loss of control of the vehicle and thus severe injuries.

- Never put too much load in the vehicle. Both the carrying capacity as well as the distribution of the load in the vehicle have effects on the driving behaviour and braking ability.
- When transporting heavy objects, the driving behaviour of the vehicle varies due to the displacement of the centre of gravity.
- Always distribute the load in the vehicle as evenly and horizontally as possible.
- Always place heavy objects in the boot before the rear axle and as far away from it as possible.
- Objects in the luggage compartment that are unsecured could move suddenly and modify the handling of the vehicle.
- Adapt your speed and driving style at all times to suit visibility, weather, road and traffic conditions.
- Accelerate with particular care and caution.

- Avoid sudden braking and manoeuvres.
- Brake earlier than usual.

### ⚠ WARNING

- Never leave your vehicle unattended, especially when the rear lid is open. Children could climb into the luggage compartment, closing the door behind them; they will be trapped and run the risk of death.
- Close and lock all the doors and the rear lid when you leave the vehicle. Before you lock the vehicle, make sure that there are no adults or children in the vehicle.

### ⚠ CAUTION

Electrical wires or, depending on the features, the antenna embedded into the rear windows could be damaged, even irreparably, if they are in contact with objects.

### 📄 Note

Straps for securing the load to the fastening rings are commercially available from accessory shops.

## Luggage compartment

### Luggage compartment shelf

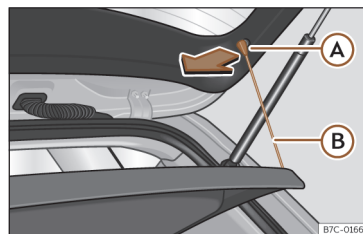

**Fig. 105** In the luggage compartment: removing and fitting the shelf.

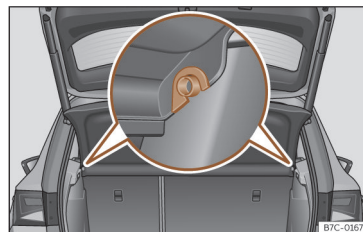

**Fig. 106** In the luggage compartment: removing and fitting the shelf.

### Removing

- Detach the cord loops»» Fig. 105 (B) from their hooks (A).

- Remove the rear shelf from the side supports»» Fig. 106 by pulling it upwards and then take it out.

If necessary, the rear shelf can be stored under the luggage compartment double floor »» page 131.

### Fitting

- Insert the cover horizontally so that the “recess” fits onto the axis of the supports »» Fig. 106 and press down until it engages.
- Hook the loops»» Fig. 105 B to the rear lid.

### ⚠ WARNING

Animals, loose or unsecured or objects carried on the rear shelf can cause serious injury in case of sudden manoeuvring or braking or in case of an accident.

- Do not leave hard, sharp or heavy objects or in bags on the rear shelf.
- Never transport animals on the rear shelf.

### ⓘ CAUTION

- Before closing the rear lid, ensure that the rear shelf is correctly fitted.
- An overloaded luggage compartment could mean that the rear shelf is not correctly seated and it may be bent or damaged.

- If the luggage compartment is overloaded, remove the tray.

### ⓘ Note

Ensure that, when placing items of clothing on the luggage compartment cover, rear visibility is not reduced.

### Store the rear shelf

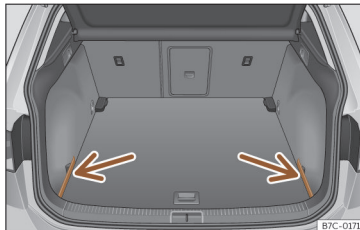

Fig. 107 In the luggage compartment: covers for storing the rear shelf.

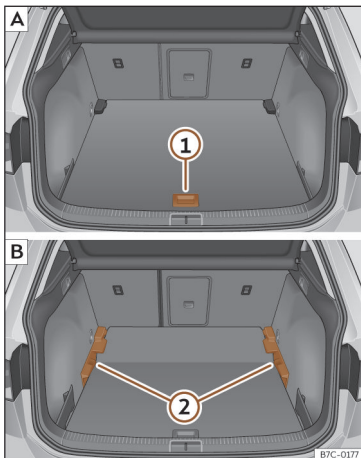

Fig. 108 In the luggage compartment: fitting the rear shelf.

Depending on the equipment, once the luggage compartment shelf has been removed, it can be stored under the boot floor.

- Remove the left and right covers »» Fig. 107.
- Place the rear shelf in the corresponding housing»» Fig. 108.
- Put the left and right covers in their original position.

## Variable luggage compartment floor



**Fig. 109** Variable luggage compartment floor: **A** raised position; **B** lowered position.

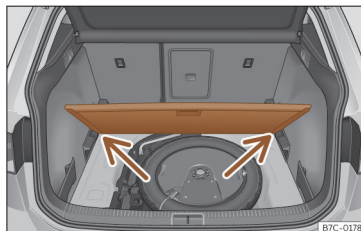

**Fig. 110** Variable luggage compartment floor: inclined position.

### Variable floor in high position

- To move from the low position to the high position, lift the floor using the handle >>> **Fig. 109 ①**, and pull it back until the front of the floor has fully passed the supports >>> **Fig. 109 ②**.
- Move the floor forward over the supports as far as the rear seat backrest and then lower the floor with the handle **①**.

### Variable floor in low position

- To move from the high position to the low position, lift the floor using the handle >>> **Fig. 109 ①**, and pull it back until the front of the floor has fully passed the supports >>> **Fig. 109 ②**.
- Now let the front part fall to the floor and slide the floor forwards as far as the rear seat backrest; lower the floor at the same time with the handle **①**.

### Variable floor in the tilted position

When the variable floor is tilted you can access the spare wheel or anti-puncture kit area.

- Lift the variable floor in the high position using handle >>> **Fig. 109 ①**, pull it up and push it towards the backrest of the rear seats until it folds along the hinge line and the movable part of the floor is resting on itself.
- Rest the floor on its housings >>> **Fig. 110** (arrows).

### Variable floor with folded seats

- To move from the high position to the low position, lift the floor using the handle >>> **Fig. 109 ①** and pull it back a little.
- Push the variable floor towards the folded rear seats with the handle **①** using some downward pressure so that the moving part of the floor is flush with the backs of the rear seats.

### **⚠ WARNING**

- Always secure objects, even when the luggage compartment floor is properly lifted.
- Only objects that do not protrude more than 2/3 the height of the floor may be carried between the rear seat and the raised luggage compartment floor.

- Only objects that do not weigh than approximately 7.5 kg may be carried between the rear seat and the raised luggage compartment floor.

### ⓘ CAUTION

- The maximum weight that can be loaded on the luggage compartment variable floor in the top position is 100 kg.
- Do not let the luggage compartment floor fall when closing it. Always carefully guide it downwards in a controlled manner. Otherwise, the lining and the floor of the luggage compartment could be damaged.

### Fastening rings

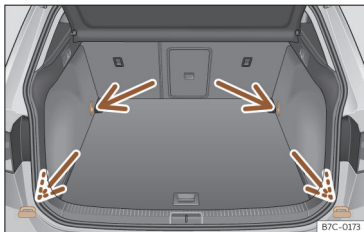

**Fig. 111** In the luggage compartment: fastening rings.

There are fastening rings»» **Fig. 111** on the front and rear of the boot to secure loose

objects and luggage with fastening belts and cords.

In order to use the fastening rings, they must be lifted beforehand.

### ⚠ WARNING

If unsuitable or damaged belts or retaining straps are used, they could break in the event of braking or an accident. Objects could then be launched across the passenger compartment and cause serious or fatal injuries.

- Always use belts or straps that are suitable and in good condition.
- Tighten the belts and straps in a cross layout over the load placed on the boot floor and secure them to the fastening rings safely.
- Never exceed the maximum tensile load of the fastening rings when securing objects.
- Make sure that, particularly for flat objects, the upper edge of the load is higher than the fastening rings.
- Depending on the features, take into account the instruction panels on the boot on how to place the load.
- Never secure a child seat to the fastening rings.

### ⓘ Note

- The maximum tensile load that the fastening rings can support is approx. 3.5 kN.
- Belts, straps and securing systems for the appropriate load can be obtained from specialised dealerships. To do so, CUPRA recommends going to a specialised CUPRA dealer or any SEAT dealership.
- The fastening rings are rendered unusable for versions with a spare wheel.

### Net bag

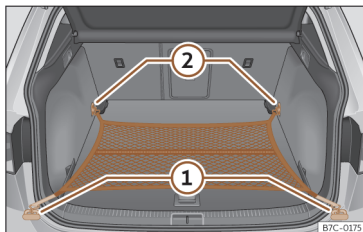

**Fig. 112** In the luggage compartment: net bag hooked up at floor level.

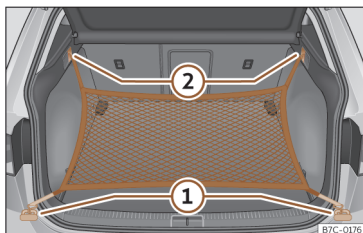

**Fig. 113** In the luggage compartment: rings ① and hooks ② for attaching the net bag.

The luggage compartment prevents light luggage from moving. The net bag has a zip and can be used to store small objects.

The net bag can be hooked up to the luggage compartment in different ways.

#### Hooking the net bag into the luggage compartment floor

If necessary, the front eyes must be unfolded first >>> page 133.

- Secure the net hooks to the fastening rings ① and ② >>> Fig. 112 >>> ⚠. The bag zip should be facing upwards.

#### Hook the net bag next to the load threshold

- Secure the short net hooks to the fastening rings >>> Fig. 113 ① >>> ⚠. The bag zip should be facing upwards.
- Secure the straps in the bag hooks ②.

#### Removing the net bag

The hooked up net bag is taut >>> ⚠.

- Release the net bag from the fastening rings.
- Store the net bag in the luggage compartment.

#### ⚠ WARNING

To secure the elastic net bag on the fastening rings of the boot it must be stretched out. Once hooked up it is taut. If the net bag is hooked up or unhooked incorrectly the hooks could cause injuries.

- Always secure the bag hooks properly so that they do not suddenly release from the fastening rings when hooking or unhooking them.
- On hooking or unhooking them, protect your eyes and face in case the hooks are released suddenly.
- Always hook up the net bag hooks in the described order. If a hook is unfastened suddenly, this may cause injuries.

### Bag hooks

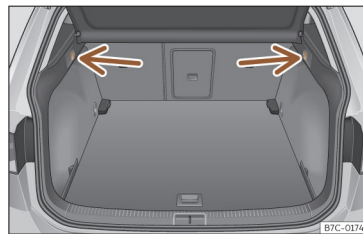

**Fig. 114** In the luggage compartment: bag hooks.

There may be hooks for hanging bags on both sides of the luggage compartment >>> Fig. 114.

The retaining hooks have been designed to secure light shopping bags.



### ⚠ WARNING

Never use the hooks to hang luggage or other objects. In case of sudden braking or an accident, the hooks could break.

### ⚠ CAUTION

Each hook is designed for a maximum load of 2.5 kg.

### Trapdoor for transporting long objects

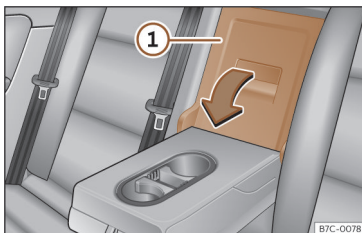

**Fig. 115** In the rear seat backrest: opening the trapdoor.

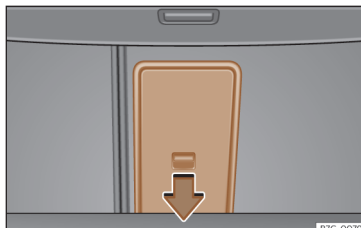

**Fig. 116** In the luggage compartment: opening the trapdoor.

On the rear seat, behind the central armrest, there is a tailboard for transporting long items in the interior, such as skis.

To avoid soiling the interior, dirty objects should be wrapped (e.g. in a blanket) before they are inserted through the tailboard.

When the armrest is down, nobody may travel in the centre rear seat.

### Opening the tailboard

- Lower the centre armrest.
- Pull the release lever in the direction of the arrow and push the tailboard cover >>> **Fig. 115** ① down and forwards.
- Open the rear lid.
- Insert the long objects through the gap from the luggage compartment.
- Secure the objects with the seat belt.

- Close the rear lid.

### Closing the tailboard

- Lift the tailboard cover until it engages. The red mark on the luggage compartment side should never be visible.
- Close the rear lid.
- Lift the centre armrest if necessary.

### Note

The tailboard can also be opened from the luggage compartment. To do so, press the release lever down, in the direction of the arrow, and the cover upwards >>> **Fig. 116**.

### Net partition

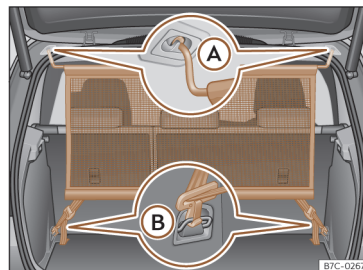

**Fig. 117** Net partition fitted.

The purpose of the net partition is to prevent the items in the boot from moving into the cabin, e.g. in the event of sudden braking.

### Fitting the net partition

The partition net can be fitted behind the rear seat or, depending on the features, behind the front seats with the second row of seats lowered.

- If required, remove the rear shelf  
»» page 130.
- Secure the net partition in the left housing of the roof»» Fig. 117 (A). Make sure to move the cross rod down beyond the upper position.
- Hook in the net partition on the rear right-hand side roof housing by pressing on the rod»» Fig. 117 (A).
- Secure two hooks of the partition net to the fastening rings of the boot»» Fig. 117 (B) and tighten the straps firmly.

To remove it proceed in reverse order.

#### WARNING

During a sudden driving or braking manoeuvre, or in the event of an accident, objects could be flung though the interior and cause serious or fatal injuries.

- Check whether the cross rods are correctly engaged.

- Always secure objects, even when the net partition is properly assembled.
- There should be nobody behind the net partition when the vehicle is moving.

#### CAUTION

If the net partition is secured incorrectly or to incorrect points, this may damage the vehicle.

## Roof carrier

### Introduction

The vehicle roof has been designed to optimise aerodynamics. For this reason, cross bars or conventional roof carrier systems cannot be secured to the roof water drains.

As the roof water drains are integrated in the roof to reduce air resistance, only CUPRA-approved cross bars and roof carrier systems can be used.

**Cases in which cross bars and the roof carrier system should be disassembled.**

- When they are not used.
- When the vehicle is washed in a car wash.
- When the vehicle height exceeds the maximum height, for example, in some garages.

#### WARNING

- Always secure the load properly using belts or retaining straps that are suitable and in a good condition.
- Bulky, heavy, long or flat loads have a negative effect on aerodynamics, the centre of gravity and driving performance.
- Avoid sudden braking and manoeuvres.
- Adapt your speed and driving style at all times to suit visibility, weather, road and traffic conditions.

#### CAUTION

- Remove the cross bars and the roof carrier system before entering a car wash.
- Vehicle height is increased by the installation of cross bars or a roof carrier system and the load secured on them. For this purpose, check that your vehicle's height does not surpass the headspace limit, for example, for underpasses or for entering garage doors.
- Cross bars, the roof carrier system and the load secured on them should not interfere with the roof aerial or hamper the path of the panoramic sun roof and the rear lid.
- On opening the rear lid make sure that it does not knock into the roof load.

### For the sake of the environment

When cross bars and a roof carrier system are installed, the increased air resistance means that the vehicle uses more fuel.

### Securing the crossbars and the roof carrier system

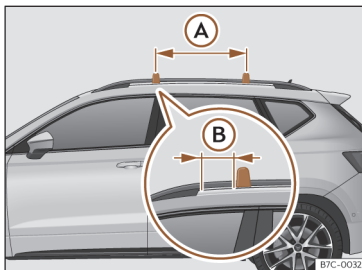

**Fig. 118** Attachment points for the roof railings for the roof carrier system.

The crossbars are the basis of a series of special roof carrier systems. For safety reasons, special fixtures must be used to safely transport luggage, bicycles, skis, surf boards or boats on the roof. The appropriate accessories can be purchased at specialised CU-PRA dealers or any SEAT dealership.

Always secure the crossbars and the roof carrier system properly. Always take the as-

sembly instructions that come with the crossbars and the roof carrier system in question into account.

The crossbars are assembled on the roof railings. The distance between crossbars >>> **Fig. 118** **A** should be between 70 and 90 cm and the distance between the crossbars and the brackets of the roof railings **B** must be 15 cm.

### WARNING

Incorrect attachment and use of the crossbars and the roof carrier system may cause the whole system to detach from the roof and cause an accident and injuries.

- Always take the manufacturer assembly instructions into account.
- Check threaded joints and attachments travelling and if necessary tighten them after you have travelled a short distance. When making long trips, check the threaded joints whenever you stop for a rest.
- Do not modify or repair the crossbars or roof carrier system.

### Note

Always read the assembly instructions that come with the crossbars and the roof carrier system carefully and keep them in the vehicle.

### Loading the roof carrier system

The load can only be secured if the crossbars and the roof carrier system are properly installed >>> .

#### Maximum authorised cargo on the roof

The maximum permissible roof load is **75 kg**. This figure comes from the combined weight of the roof carrier, the cross bars and the load itself on the roof >>> .

Always check the weight of the roof carrier system, the cross bars and the weight of the load to be transported and weigh them if necessary. Never exceed the maximum authorised roof load.

If you are using cross bars and a roof carrier with a lower weight rating, you will not be able to carry the maximum authorised roof load. In this case, do not exceed the maximum weight limit for the roof carrier which is listed in the fitting instructions.

#### Distributing a load

Distribute loads uniformly and secure them correctly >>>  **>>>**

## Check attachments

Once the cross bars and roof carrier system have been installed, check the bolted connections and attachments after a short journey and subsequently with a certain frequency.

### WARNING

- Never exceed the maximum authorised load on the roof and on the axles or the vehicle's maximum authorised weight.
- Never exceed the load capacity of the cross bars and the roof carrier system, even if the maximum authorised roof load has not been reached.
- Secure heavy items as far forward as possible and distribute the vehicle load uniformly.

### WARNING

If the load is loose or not secured, it could fall from the roof carrier system or cause accidents and injuries.

- Always use belts or retaining straps that are suitable and in a good condition.

## Storage compartment

### Introduction

Use the storage compartments only for small or light items.

### WARNING

Objects in the driver's footwell could difficult the use of the pedals. This may cause loss of control of the vehicle and increases the risk of severe injuries.

- Make sure that nothing prevents you from using the pedals at any time.
- Always secure the mat in the footwell.
- Never place other mats or other type of covers on the factory-fitted mat.
- Ensure that no objects can fall into the driver's footwell while the vehicle is in motion.
- When the vehicle is stationary, remove the objects in the footwell.

### WARNING

If you leave lighters inside the vehicle, they might be damaged or lit inadvertently. This could lead to severe burns and damage to the vehicle.

- Before moving a seat, make sure there are no lighters in the moving part area of the vehicle.

- Before closing a storage compartment, make sure there are no lighters in the closing area.

- Never leave a lighter inside a storage compartment or any other surface of the vehicle as it could ignite due to the high temperatures on such surfaces, particularly during the summer.

### CAUTION

- Do not store heat- or cold-sensitive objects, food or medicines in the cabin. Heat and cold could damage them or render them useless.
- Objects made from transparent materials left inside the vehicle, such as glasses, magnifying glasses or transparent suction pads stuck to the windows can concentrate sunlight and damage the vehicle.

## Glove compartment

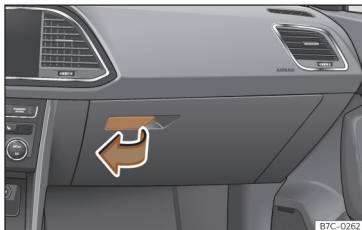

**Fig. 119** On the front passenger side: glove compartment.

### Opening and closing the glove compartment

*Opening:* Pull the handle»» **Fig. 119** and open the glove compartment.

*Closing:* Press the glove compartment upwards.

#### **⚠ WARNING**

If the glove compartment is left open, the risk of causing severe injuries in the event of an accident, sudden braking or manoeuvring increases.

- Always keep the glove compartment closed while the vehicle is in motion.

## Storage compartment under front seats

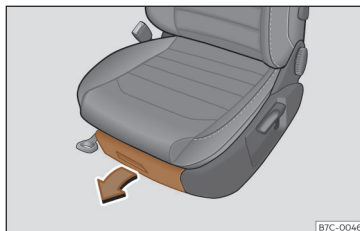

**Fig. 120** Storage compartment under the front seats.

*Opening:* Press the tab on the drawer handle and take the drawer out.

*Closing:* Push the drawer under the seat until it engages.

#### **⚠ WARNING**

If the drawer is left open, it could prevent use of the pedals. This may cause serious accidents and injuries.

- Always keep the drawer closed while the vehicle is in motion. Otherwise, the drawer and any objects in it could fall into the driver's footwell and obstruct the pedals.

#### **⚠ CAUTION**

The drawer can contain 1.5 kg at most.

## Drink holder



**Fig. 121** Centre console: front drinks holders.

The storage compartments of the driver and passenger doors contain a bottle holder.

### Front drink holders

There are two cup holders in the centre console»» **Fig. 121**.

#### **⚠ WARNING**

Incorrect use of the bottle holders may cause injuries.

- Never put hot drinks in the drink holders. In the event of sudden braking or an accident while driving, hot beverages in the bottle holders might spill and cause burns.
- Ensure that no bottles or other objects are dropped in the driver footwell while driving, as they could get under the pedals and obstruct their working.

»

- Never place glasses, food or other heavy objects drink holders. These heavy objects may be thrown across the cabin in the event of an accident and cause serious injuries.

### ⚠ WARNING

Closed bottles may explode inside the vehicle due to cold or heat.

- Never leave closed bottles in the vehicle if the temperature inside is very high or very low.

### ⓘ CAUTION

Do not leave open cans in the drink holders when the vehicle is in motion. If the drink is spilled (e.g. due to sudden braking) it may damage the vehicle and its electrical system.

### 📄 Note

The inside elements of the drink holders can be extracted for cleaning.

## Other object holders

You will find more object holders, compartments and supports in other parts of the vehicle:

- In the centre console.

- In the top of the glove compartment in vehicles that do not have a CD reader. The load of the compartment should not exceed 1.2 kg.

- Other storage compartments are found in the rear seat, to the left and the right of the seats.

There are hangers on the struts of the doors and the rear.

### ⚠ WARNING

Hanging clothes may decrease the driver's visibility, which may cause serious accidents and injuries.

- Always hang clothes from hangers in such a way that the driver's visibility is not affected.
- Only hang light pieces of clothing from the hangers of the vehicle. Never leave heavy, hard or sharp objects in the pockets of these pieces of clothing.
- Do not use clothes hangers to hang up the clothing, as this could interfere with the function of the head-protection airbags.

## Power sockets

### Vehicle power sockets

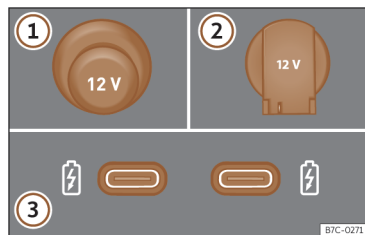

Fig. 122 Vehicle 12 volt socket.

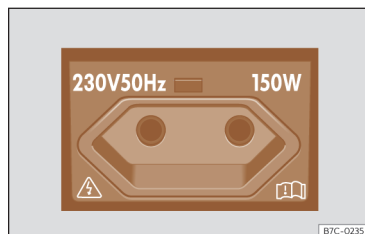

Fig. 123 On the left side of the luggage compartment: 230 volt power socket.

12 volt power socket»» Fig. 122:

- ① In the centre console
- ② On the left side of the luggage compartment

- ③ In the rear part of the centre console: (USB socket).

### In the centre console

- Remove the cover from the socket, located on the centre console»» Fig. 122 ①.
- Insert the plug of the electrical appliance into the power socket.

### In the luggage compartment

- Lift the power socket cover»» Fig. 122 ②.
- Insert the plug of the electrical appliance into the power socket.

### USB power sockets

Depending on the equipment and the country, the vehicle may also have USB connections **exclusively for charging or as a power socket**.

These USB ports are located at the rear of the console, between the front seats ③. These connectors can work at a maximum power of up to 10.5 W per port.

They are **not** intended for file playback.

### Maximum power consumption

Power socket	Maximum power consumption
12 Volts	120 Watts
230 Volts	150 watts (300 watt peaks)

Electrical equipment can be connected to the 12 volt power socket.

Make sure that the maximum power consumption displayed on each outlet is not exceeded. The power consumption of devices is shown on the model plate.

When connecting two or more electrical devices at the same time, make sure that their total consumption never exceeds 190 watts »» ④.

### 230 volt power socket

With the engine running, the power socket »» Fig. 123 activates automatically as soon as a connector is plugged in. If there is enough power available, the socket can still be used while the engine is off »» ⚠

*Connect an electrical device:* Open the cover and insert the plug into the power socket as far as possible to unlock the built-in child lock. The socket only supplies power once the child lock is unlocked.

### LED on the power socket

Steady green light:	The childproof lock is unlocked. The socket is ready to operate.
Flashing green light:	The ignition is switched off, but there is enough power available to continue supplying the socket with current for a maximum of 10 minutes. If the connector is unplugged before this time elapses, the socket is disconnected and cannot be used again until the ignition is switched on again.
Flashing red light:	There is an anomaly, e.g. disconnection due to a current surge or overheating.

### Disconnection due to overheating

When the temperature exceeds a certain value, the 230 volt socket inverter is automatically disconnected. The disconnection prevents overheating when the power consumption of the connected devices is excessive or the ambient temperature is very high. The 230-volt power supply can be used once again after a cooling time. First unplug the connector of the connected device and then plug it back in again. This prevents the electrical device from being switched on again if this is not wanted.

### ⚠ WARNING

The electrical system is under high voltage! »

- Do not spill liquids onto the socket.
- Do not plug adapters or extension cords into the 230 volt power socket. Otherwise, the integrated child lock will be unlocked and the power socket will operate.
- Do not insert conductive objects (a knitting needle, for example) into the 230 volt power socket.

### WARNING

The power socket works only when the ignition is on. Improper use may cause serious injury or even fire. Children should therefore not be left in the vehicle unattended if the button is also left behind. Otherwise there is a possibility that they may be injured.

### CAUTION

Always use the correct type of plugs to avoid damaging the sockets.

### CAUTION

- 230 volt power socket:
  - Do not leave devices or connectors that are too heavy (e.g. a transformer) hanging directly from the power socket.
  - Do not connect neon lamps.
  - Only connect devices to the socket if the device and socket voltage match.

- The built-in overload disconnect function prevents any electrical devices that require a high start-up current from turning on. In this case, unplug the electrical device's power supply and re-try the connection after about 10 seconds.

### Note

- The use of electrical appliances with the engine switched off will cause a battery discharge.
- Should the connected appliance overheat, immediately switch it off and disconnect it from the socket.
- Before switching the ignition on or off, unplug the appliances from the USB ports to protect them from any damage caused by fluctuations in voltage.
- Some appliances may not work properly when connected to the 230 volt sockets due to a lack of power (watts).

## Air conditioning

### Heating, ventilation and cooling

#### Introduction

The **Climatronic** is an automatic air conditioner that heats, cools and dehumidifies the air.

With the Climatronic's automatic mode it is possible to automatically regulate the air temperature, distribution and flow.

The air conditioning system is more effective if the vehicle's interior is kept closed. When a lot of heat builds up inside the vehicle, ventilation can speed up the cooling process.

To switch a specific function on, press the appropriate button. Press the button again to switch off the function.

The illuminated LEDs next to the buttons indicate that the function is switched on.

In the air conditioning settings in the infotainment system, the yellow function buttons indicate that the function is switched on >>> page 145.

#### Dust and pollen filter

The dust and pollen filter with its activated charcoal cartridge serves as a barrier against



impurities in the air taken into the vehicle interior.

The dust and pollen filter must be changed regularly so that air conditioner performance is not adversely affected.

If the filter loses efficiency prematurely due to use in areas with very high levels of air pollution, the filter must be changed more frequently than stated in the Service Schedule.

### Economic use of the air conditioning

When the air conditioning is switched on, the compressor consumes engine power and has influence on fuel consumption.

The air conditioner operates most effectively with the windows and the panoramic sliding sunroof closed. However, if the vehicle has heated up after standing in the sun for some time, the air inside can be cooled more quickly by opening the windows and the panoramic sliding sunroof briefly.

### WARNING

Reduced visibility through the windows increases the risk of serious accidents.

- Always ensure that all windows are free of ice and snow, and that they are not fogged, so as to maintain good visibility of everything outside.
- Only drive when you have good visibility.

- Always ensure that you use the air conditioning, heater or rear window heating to maintain good visibility to the outside.
- Never leave the air recirculation on for a long period of time. If the cooling system is switched off and air recirculation mode switched on, the windows can mist over very quickly, considerably limiting visibility.
- Switch air recirculation mode off when it is not required.

### CAUTION

- To replace the pollen filter, always visit a service centre.
- Switch the climate control or air conditioner off if you think it may be broken. This will avoid additional damage. Have the climate control or air conditioning checked by a specialised workshop.
- Repairs to the climate control or air conditioning require specialist knowledge and special tools. CUPRA recommends going to a specialised CUPRA Service or SEAT Official Service.

### Note

- When the cooling system is turned off, air coming from the outside will not be dried. To prevent fogging of the windows, CUPRA recommends leaving the cooling system (compressor) turned on. To do this, press

the  button. The button lamp should light up.

- The maximum heat output required to defrost windows as quickly as possible is only available when the engine has reached its normal running temperature.
- Keep the air intake slots in front of the windscreen free of snow, ice and leaves to ensure heating and cooling are not impaired, and to prevent the windows from misting over.
- The air from the vents flows through the vehicle interior and is extracted by slots in the luggage compartment designed for this purpose. Therefore, you should avoid obstructing these slots with any kind of object.
- Do not smoke while air recirculation mode is on, as smoke drawn into the air conditioning system leaves residue on the evaporator, producing a permanent unpleasant odour.
- It is advisable to turn on the air conditioning at least once a month, to lubricate the system gaskets and prevent leaks. If a decrease in the cooling capacity is detected, a Technical Service should be consulted to check the system.
- When the engine is under extreme strain, switch off the compressor for a moment.

## Climatronic controls and functions



**Fig. 124** In the centre console: Climatronic controls.

### Temperature ①/②

The temperature of the right and left sides can be adjusted separately using the adjusters. The selected temperature is shown on the display of the climate control panel.

**Synchronisation:** press button **SYNC** so that settings on the driver's side apply to the passenger side. Use the temperature regulator for the passenger side to set a different temperature.

### AUTO

The set air temperature is kept constant. Temperature and the amount and distribution of air are controlled automatically. Automatic mode is switched off when the fan power is changed manually.

### Cooling mode **A/C**

Press the button to switch on or off the cooling system.



The cooling mode cools and dehumidifies the air.

### Blower

Adjust the fan power.

### Air distribution / /

The airflow adjusts automatically for comfort. It can also be manually distributed to the desired zone by pressing the corresponding button:

-  The airflow is directed towards the chest
-  The airflow is directed towards the footwell.

-  The airflow is directed at the windscreen.

### Maximum cooling power **A/C MAX**

The recirculation of air and the cooling system turn on automatically and air distribution adjusts automatically to the position .

### Defrost/demist function **MAX**

The Climatronic's defrost function removes ice and fog from the windscreen. The air is dehumidified and the fan is set high.

### Infotainment System **SETUP**

Open the air conditioning settings in the infotainment system >>> page 145.

The climate control operation and settings menu will be displayed in the infotainment system screen.

**Heated rear window** 

Switches the heated rear window on and off.

This only works when the engine is running and switches off automatically after a maximum of 10 minutes.

It should be switched off as soon as the glass is demisted. By saving electrical power you can also save fuel.

To avoid possible damage to the battery, an automatic temporary disconnection of this function is possible, coming back on when normal operating conditions are re-established.

**Air recirculation** 

Switches the air recirculation mode on and off >>> page 146

**Seat heating** 

Switches seat heating on and off >>> page 147

**Switching off OFF**

Switch off the air conditioning system. If the fan is manually set to 0, it also switches off.

**Air Care**

The Air Care Climatronic allergen filter can reduce the amount of harmful substances that get inside, including allergens >>> page 146.

**Windscreen heating** 

Switches the heated windscreen on and off with the engine running >>> page 148.

**Steering wheel heating** 

Activate or deactivate steering wheel heating >>> page 148.

**Setting the temperature on the infotainment system**

The air conditioning settings in the infotainment system are available in the Climatronic. Depending on the vehicle equipment.

**Open the air conditioner menu**

- Press the **SETUP** button of the Climatronic control panel.

The current air conditioning settings are displayed at the top of the screen. The current air conditioning settings are displayed at the top of the screen.

**Air conditioning operating modes**

The air conditioning operating modes are colour coded:

- Blue: Cooling.
- Red: Heating.

**General settings submenu**

Sets the following functions:

- Automatic air recirculation mode >>> page 146.
- Automatic heated windscreen >>> page 148.

**Presets submenu**

Sets the automatic or manual mode of the cooling system or switches the air conditioning off.

**Air conditioning profile**

Adjust the power of the fan in AUTO mode.

**Air vents**

To ensure proper heating, cooling and ventilation in the vehicle interior, the air vents must remain open.

- Turn the corresponding thumbwheel in the required direction to open and close the air vents. When the thumbwheel is in the ► position, the corresponding air vent is closed.
- Change the air direction using the ventilation grille lever.

There are other additional, non-adjustable air vents in the dash panel, in the footwells »

and in the rear area of the passenger compartment.



### Note

**Food, medicine and other heat or cold sensitive objects should never be placed in front of the air outlets as they may be damaged or made unsuitable for use by the air.**

### Air recirculation

Air recirculation mode prevents the ambient air from entering the interior.

For safety reasons, air recirculation is switched off in the following situations:

- When the button  MAX is pressed or the air distributor is turned to .
- When a sensor detects that the vehicle's windows could mist up.

### Switching the manual air recirculation mode on and off

- Press the button  to connect or disconnect manual air recirculation.

### Climatronic automatic air recirculation mode

With the automatic air recirculation mode activated, the entry of fresh air into the cabin interior is enabled. If the system detects a

high concentration of hazardous substances in the ambient air, air recirculation mode is switched on automatically. When the level of impurities drops to within a normal range, recirculation mode is switched off.

The system is unable to detect unpleasant smells.

The air recirculation will **not** connect automatically in versions without humidity sensor and in the following external conditions:

- The outside temperature is lower than +3°C (+38°F).
- The cooling system is switched off and the outside temperature is below +10°C (+50°F).
- The cooling system is switched off, the outside temperature is below +15°C (+59°F) and the windscreen wipers are switched on.

### Air Care Climatronic with allergen filter

The Air Care Climatronic allergen filter can reduce the amount of harmful substances, including allergens, that get inside.

If the Air Care option is switched on, the air conditioning's air recirculation mode is maximised until there is a risk of the windows misting up due to humidity inside the vehicle and the outside temperature. The air recirculation mode is automatically regulated and incorporates an automatic setting to prevent the vehicle occupants suffering from fatigue.

- Open the air conditioning settings in the infotainment system»» page 145 .
- Switch the Air Care function on or off using **active Air Care**.

### WARNING

**Stuffy or used air will increase fatigue and reduce driver concentration possibly resulting in a serious accident.**

- **Never leave the fresh air fan turned off or use the air recirculation for long periods of time; the air in the vehicle interior will not be refreshed.**
- **If the cooling system is switched off and air recirculation mode switched on, the windows can mist over very quickly, considerably limiting visibility.**

### CAUTION

**Do not smoke when air recirculation is switched on in vehicles with an air conditioner. The smoke taken in could lie on the cooling system vaporiser and on the activated charcoal cartridge of the dust and pollen filter, leading to a permanently unpleasant smell.**

**Note**

- **Climatronic: air recirculation mode is activated to prevent exhaust gas or unpleasant odours from entering the vehicle interior when it is in reverse and while the automatic windscreen wiper is working.**
- **When the outside temperature is very high, selecting manual air recirculation mode for a short period refreshes the vehicle interior more quickly.**







**Seat heating**

With the engine running, the front seats and side rear seats can be electrically heated to three power levels.

**Seat heating power levels**

Seat heating operating modes are colour coded. At the highest heating level, all three LEDs light up.

**Control seat heating**

- Press buttons  or  on the control panel to turn on the seat heating as high as possible.
- Press buttons  or  repeatedly to adjust it to the required level.
- To turn off the seat heating, press button  or  repeatedly until no LEDs are lit.

When the engine is started again within approximately 10 minutes, the most recently set heating level for the driver's seat is switched on automatically.

**Cases in which the heat seating should not be switched on**

Do not switch the seat heating on if any of the following conditions are met:

- If the seat is occupied by a person with limited pain or temperature perceptions >>> 
- The seat is not occupied.
- The seat has a cover.
- A child seat has been installed on the seat.
- The seat cushion is wet or damp.
- The outdoor or indoor temperature is greater than +25°C (77°F).

**WARNING**

People who cannot perceive pain or temperature because of medications, paralysis or chronic diseases (e.g. diabetes) or have a limited perception of these, may suffer burns to the back, buttocks or legs when using seat heating.

- People with limited pain and temperature thresholds must never use seat heating.
- If an abnormality in the device's temperature control is detected, have it checked by a specialist workshop.

**WARNING**

If the fabric of the cushion is wet, this can adversely affect the operation of the seat heating, increasing the risk of burns.

- Make sure the seat cushion is dry prior to using the seat heater.
- Do not sit on the seat with clothing that is wet or damp.
- Do not leave clothing that is wet or damp on the seat.
- Do not spill liquid on the seat.

**CAUTION**

To avoid damaging the heating elements of the seat heaters, please do not kneel on the seat or apply sharp pressure to a single point on the seat cushion or backrest.

- Liquids, sharp objects and insulating materials (e.g. covers or child seats) can damage the seat heating.
- If the seat heating generates any kind of odour, it must be switched off immediately and it should be checked by a specialist service centre.
- If you have replaced the original upholstery with another material, the seat heating may overheat or its operation may be limited. >>>

### For the sake of the environment

To save fuel, turn off the seat heating as soon as possible.

## Steering wheel heating

Steering wheel heating works only with the engine running.

### Steering wheel heating levels

The selected flywheel heating level will be displayed on the instrument panel display.

Level control is carried out using the  button on the multifunction steering wheel:

- *Brief press (less than 1 second)*: the heating is switched on at maximum level. Press the steering wheel button repeatedly until the desired level is adjusted. To switch off steering wheel heating, press the steering wheel button repeatedly until the heated steering wheel **OFF** icon is displayed on the instrument cluster.
- *Long press (more than 1 second)*: the heating is switched off directly from the level that is currently operating. If the steering wheel button is pressed again for a long period, the heating is switched on directly at the last level saved before switching off.

### Automatic off

The steering wheel heating will be switched off automatically when any of the following conditions are met:

- Power consumption is too high.
- The steering wheel heating system is faulty.
- If the ignition is switched off.

## Windscreen heating

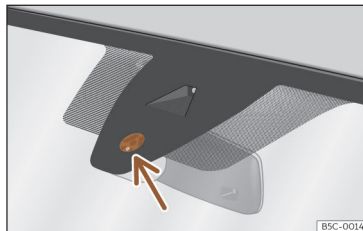

**Fig. 125** Windscreen humidity and temperature sensor.

The brake servo works only when the engine is running.

The heated windscreen is comprised of a set of heated wires placed between the layers of the windscreen which, when electric current is supplied to them, heat up and cause the temperature of the glass to rise.

Its function is to assist the air-conditioning system to prevent the windscreen from misting up or to demist it faster if it does mist up.

The system can be switched on manually or automatically.

### Manual activation

- Press the button  in the air conditioning settings in the infotainment system.

The heated windscreen is switched off based on the outside temperature and, in any case, after approximately 8 minutes.

### Automatic activation

The heated windscreen switches on automatically when a window is at risk of misting up.

- Open the air conditioning settings in the infotainment system >>> page 145.
- Switch the automatic heated windscreen on or off.

The automatic heated windscreen is switched on, even when the air conditioning is switched off.

### Thermal windscreen using the defrost function

If the defrost function is switched on and a sensor detects that the windscreen could mist up, the heated windscreen switches on.

### When does the heated windscreen switch off?

The heated windscreen switches off when one of the following conditions is met:

- Power consumption is too high.
- The air conditioner fuse is faulty.
- If the preset time has elapsed.

### Troubleshooting

#### Cooling mode cannot be switched on or operates in a limited way

The cooling mode works only with the engine running and if the ambient temperature is above +3 °C (+38 °F). When the engine is very hot, the cooling mode is deactivated.

- Switch on the fan.
- Check the air conditioning fuse  
»» page 56.
- Dust and pollen filter
- If the fault continues, consult a specialised workshop.

#### The heating and fresh air system cannot be switched on or operates in a limited way

- The heating and fresh air system and the defrost function operate best when the engine is hot.

- If the fault continues, consult a specialised workshop.

#### The windows are misted up

Windows mist up when they are cooler than the ambient temperature and the air is very damp. Cold air can absorb less moisture than hot air, so the windows mist up more often in cold weather.

- The air vent in front of the windscreen keeps it free of ice, snow and leaves, which improves the performance of the heating and cooling systems.
- The air grooves located at the rear of the luggage compartment must be kept clear to allow the air to circulate through the vehicle from front to back.
- Switch on the demist function  
»» page 144.

#### The temperature unit is not correct

Use the infotainment system to change the units for all of the vehicle's temperature displays.

#### Water or water vapour under the vehicle

When the outside air is very humid and the ambient temperature is high, condensation may drip from the evaporator of the cooling system, which can form a puddle under the

vehicle. This is completely normal and is no indication of a leak.

If the outside air is very humid and the ambient temperature is low, the auxiliary heating can evaporate the condensation. In this case, steam may come out from under the vehicle. This does not mean that the vehicle has broken down.

# Infotainment system

## Introduction

### First steps

#### Introduction

Infotainment functions and settings depend on the country and equipment

#### Before first use

Before the first use, bear in mind the following points, to take full advantage of the functions and settings offered:

- Observe the basic safety warnings  
»» page 150.
- Reset the Infotainment factory settings.
- Search and store favourite radio stations on the preset buttons so you can tune them quickly.
- Use only suitable audio sources and data media.
- Pair a mobile phone to use phone management through the Infotainment system.
- Use current maps for navigation.
- Register in CUPRA CONNECT to run the corresponding services.

#### Current documentation attached

For using infotainment and its components, take into account, together with this instruction manual, the following documentation:

- Supplements to your vehicle's on-board documentation.
- Instruction Manual of the mobile phone device or audio sources.
- Operating instructions for data media and external players.
- Manuals for the Infotainment accessories subsequently installed or used additionally.
- Description of services when running CUPRA CONNECT services.

#### Safety instructions

Some function areas may include links to third-party websites. CUPRA is not the owner of the third-party websites accessible through the links, and assumes no liability for their content.

Some function areas may include outside information from third-party providers. CUPRA is not responsible for such information being correct, up-to-date or complete, or for ensuring it does not infringe the rights of third parties.

Radio stations and owners of data media and audio sources are responsible for the information they transmit.

Bear in mind that parking lots, tunnels, tall buildings, mountains or due to the operation of other electrical devices, such as chargers, can also interfere with the reception of the radio signal.

Foils or adhesives with metallic layers on the antenna and on the window panes can interfere with radio reception.

#### WARNING

The infotainment central computer is interconnected with the control units mounted on the vehicle. Therefore, there is a serious danger of accident and injury if the central computer is repaired or disassembled and reassembled incorrectly.

- Never replace the central computer with another used, recycled or from another vehicle at the end of its useful life.
- The repair or disassembly and reassembly of the central computer should only be carried out at specialised workshops. To do so, CUPRA recommends going to a specialised CUPRA dealer or any SEAT dealership.

#### WARNING

The factory assembled radio with integrated software is interconnected with the control units mounted on the vehicle.



Therefore, there is a serious danger of accident and injury if the radio is repaired or disassembled and reassembled incorrectly.

- Never replace the radio with another radio that is used, recycled or from another vehicle at the end of its useful life.
- The repair or disassembly and reassembly of the radio should only be carried out at specialised workshops. To do so, CUPRA recommends going to a specialised CUPRA dealer or any SEAT dealership.

### WARNING

Any distraction affecting the driver in any way can lead to an accident and cause injuries. Reading the information on the screen and managing the infotainment system can distract your attention from traffic and cause an accident.

- Always drive as carefully and responsibly as possible.

### WARNING

Connecting, inserting or removing an audio source or data media while driving can distract your attention from the traffic and cause an accident.

### WARNING

Select volume settings that allow you to easily hear signals from outside the vehicle

at all times (e.g. emergency services sirens).

- Hearing may be impaired if using too high a volume setting, even if only for short periods of time.

### WARNING

The following circumstances may result in an emergency call, phone call or data transmission not being made or being interrupted:

- When in areas with zero or insufficient mobile telephony or GPS signal. Also in tunnels, confined areas between very tall buildings, garages, underpasses, mountains and valleys.
- When in areas with sufficient mobile phone or GPS signal, the telephony network of the telecommunications provider has interference or is not available.
- When the vehicle components necessary to make emergency calls, phone calls and to transmit data are damaged, do not work or do not have sufficient electrical power.
- When the battery of the mobile phone device is discharged or its charge level is insufficient.

### WARNING

In some countries and some telephone networks it is only possible to make an emergency call, if a mobile telephone de-

vice is connected to the telephone interface of the vehicle, inside it there is an “unlocked” SIM card with sufficient balance to make calls and with sufficient network signal coverage.

### WARNING

Read and observe the operating instructions provided by the manufacturer in question when using mobile phone devices, data media, external devices, external audio and multimedia sources.

### WARNING

Position the connection cables of the audio sources and external devices so that they do not interfere with the driver.

### WARNING

When changing or connecting an audio or multimedia source may cause sudden changes in the volume.

- Lower the volume before connecting or switching to audio or multimedia sources.

### WARNING

If mobile phone and radiocommunication devices are used without connection to an external antenna, the maximum electromagnetic radiation levels inside the vehicle might be surpassed, thus posing a risk to the health of the driver and passengers.

This is also the case if the external antenna has not been correctly installed.

- Keep a distance of at least 20 centimetres between the antennas of the mobile phone device and an active medical device, such as a pacemaker, as mobile phones might alter the functioning of these devices.
- Do not carry a mobile phone switched on very close or directly on top of an active medical device, for instance in a chest pocket.
- Immediately turn off the mobile phone if you suspect it is causing interferences in an active medical device or any other medical device.

### WARNING

Mobile phones, external devices and accessories that are loose or not properly secured could move around the passenger compartment during a sudden driving or braking manoeuvre or an accident and cause damage or injury.

- Set mobile phone devices, external devices and their accessories outside the air-bag deployment areas or store them securely.

### WARNING

The centre armrest may obstruct the driver's arm movements, which could cause an accident and severe injuries.

- Keep the storage compartments of the centre armrest closed at all times while the vehicle is in motion.

### WARNING

If the light conditions are not good and the screen is damaged or dirty, the indications and information displayed on the screen may not be read or be read incorrectly.

- The indications and information displayed on the screen should never induce to take any risk that compromises safety. The screen is not a replacement for driver awareness.

### WARNING

Radio stations can transmit disaster or hazard announcements. The following conditions prevent such notices from being received or issued:

- When in areas with zero or insufficient radio signal. Also in tunnels, confined areas between very tall buildings, garages, underpasses, mountains and valleys.
- When the frequency bands of the radio station have interference or are not available in areas with sufficient radio signal reception.

- When the speakers and the vehicle components necessary for radio reception are damaged, do not work or do not have sufficient electrical power.

- When the infotainment is switched off.

### WARNING

Switch off mobile phone devices in areas with a risk of explosion!

### WARNING

The driving recommendations and traffic indications shown on the navigation system may differ from the current traffic situation.

- Traffic signs, signalling systems, traffic regulations and local circumstances prevail over driving recommendations and navigation system indications.
- Adapt your speed and driving style to suit visibility, weather, road and traffic conditions.
- Certain circumstances can significantly initially planned lengthen both the duration of the trip and the route to the destination, or even temporarily prevent navigation to it, for example, if a road is closed to traffic.

### Note

In areas where special regulations apply or the use of mobile phones is forbidden, the

mobile device in question must be switched off at all times. The radiation produced by a mobile phone device when switched on may interfere with sensitive technical and medical equipment, possibly resulting in malfunction or damage to the equipment.

### Note

If the playback volume is excessive or distorted, the speakers may be damaged.

## Overview and controls

### Connect System

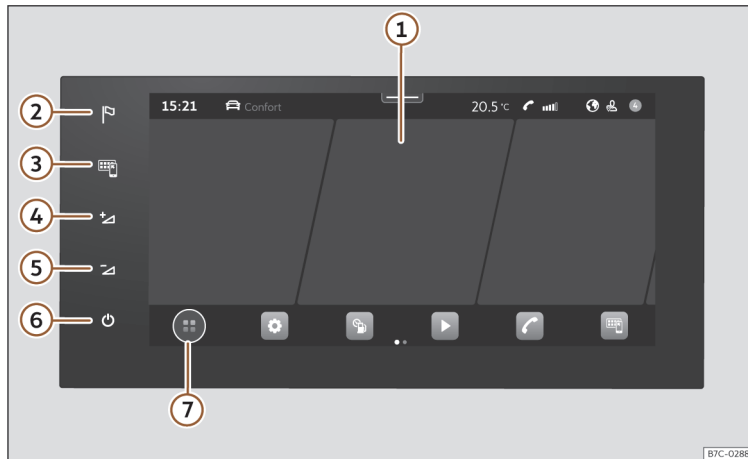

Fig. 126 Overview: control unit

- ① Touch screen. The infotainment functions can be used through the screen.
  - ② Navigation Menu
  - ③ Full Link menu
  - ④ Turn volume up
  - ⑤ Turn volume down
  - ⑥ Turn the infotainment on/off
  - ⑦ HOME button.
- @: main menu with widget views.  
⊕: main menu in mosaic mode.

## General instructions for use

### Operating indications

- The infotainment needs a few seconds for the complete start-up of the system and during that time it does not react to inputs. Only the image of the rear view camera system can be displayed during system start-up.
- The display of all indications and the execution of functions only takes place once the infotainment system has finished booting. The duration of the system booting depends on the number of infotainment functions and may take longer than normal in the event of very high or very low temperatures.
- When using the infotainment system and corresponding accessories, e.g., headphones, bear in mind country-specific regulations and legal provisions.
- Some functions of the infotainment system require an active CUPRA CONNECT user account and an Internet connection for the vehicle. The data transmission must not be limited to perform the functions.
- To use the infotainment system, simply lightly press a button or touch the screen.
- For the correct operation of the infotainment system it is important that it is switched on and that, if necessary, the time and date of the vehicle are set correctly.

- If a function button is missing on the screen, it is not a device defect, but corresponds to the specific equipment of the country or version.
- Some infotainment functions can only be selected when the vehicle is at a standstill. In some countries, the selector lever must also be in the parking position **P** or in neutral position **N**. It is not a malfunction, but is due to compliance with legal provisions.
- Restrictions on the use of devices using Bluetooth® technology may apply in some countries. For further information, contact the local authorities.
- If you disconnect the 12-volt battery, turn on the ignition before restarting the infotainment system.
- If the setup is changed, this may change the display on the screen and in some cases, the infotainment system may behave in a manner different to that described in this instruction manual.
- Ensure that any repairs or modifications that need to be carried out on the infotainment system are carried out by a specialised workshop. To do so, CUPRA recommends going to a specialised CUPRA dealer or any SEAT dealership.
- Using a mobile phone device inside the vehicle may cause noise in the speakers.
- In some countries, the infotainment system automatically shuts off when the engine

is switched off and the vehicle's 12-volt battery charge level is low.

- On vehicles with park assist, the audio source volume is automatically lowered when reverse gear is selected, as well as when the doors are opened. The volume reduction can be adjusted.
- Information about the included software and the license conditions can be found in **Settings > Copyright**.
- When selling or lending the vehicle, make sure that all saved data, files and settings have been deleted and, if necessary, external audio sources and data media have been removed.

#### Note

You will find more information and tips for using the infotainment system in the Help menu.













### HOME screen

In the control and display unit you can set up the views and representation on the home screen or use the factory setting templates.

If an icon is missing on the screen, it is not a device defect, but corresponds to the specific equipment of the country or version.

The following menus can be included as an icon on the home screen: »

## Main menus on the home screen

-  Navigation»» page 181
-  Radio»» page 174, Multimedia »» page 178
-  Telephone»» page 188
-  Full Link»» page 166
-  Setup»» page 157
-  Vehicle»» page 86
-  Data»» page 85
-  Air conditioning»» page 142
-  Sound
-  Users
-  Store
-  Legal
-  Help

## Managing the infotainment system

Execute the functions and settings with the infotainment controls.

Depending on the equipment, the infotainment system has different controls:

- Touch screen.
- Touch zones outside the screen, for example, Volume (+ -).

### Help Menu

This menu displays information on the operation of the infotainment system and gives practical tips.

- Press  **Help**.

### Connecting and disconnecting the infotainment system

The infotainment system turns on when the ignition is switched on, unless it has been manually turned off beforehand.

The infotainment system starts-up with the last set volume, provided that this does not exceed the preset maximum start-up volume.

The infotainment system automatically turns off when the driver's door is opened, provided the ignition has been switched off beforehand.

### Moving objects and adjusting volume

Move objects on the screen to adapt settings, for example, with scrollable buttons or to move the areas of a menu.

Depending on the equipment, customise menus and views.

### Increasing and reducing images or map sizes

*Tip: use your thumb and index finger.*

- Press on the map with both fingers at the same time and leave them on the screen.
- To enlarge views, slowly separate one finger from the other. To reduce views, slowly bring one finger towards the other.

#### Note

**If you turn on the infotainment system manually with the ignition off, it will automatically turn off after about 30 minutes.**

## Customising the infotainment system

Customise the menus and infotainment views to quickly access your favourite or most frequently used functions.

The main menu contains function buttons for accessing all of the Infotainment apps.

### Customise shortcuts

At the bottom of the screen you will find shortcuts to customisable system functions.

Use the settings to delete or replace them, or change their order.

- Press and hold one of the icons (or press + of an empty position) to display an additional window.
- Select one of the icons from the apps bar.
- Press X to delete an icon.
- Click on an icon in the additional window to replace the value.
- Hold your finger on one of the icons and drag it to the desired position.
- To close the edit mode, press X in the additional window, or press Ⓜ.

#### Note

The shortcut bar cannot be edited when the vehicle is moving.









## Settings (system and sound)

The selection of possible settings varies depending on the country, the equipment in question and the equipment of the vehicle.

### Modifying settings

The meaning of the following symbols are valid for all system and sound settings.

All changes are automatically applied when the menus are closed.

Symbol and its meaning	
	The setting is selected and activated or connected.
	The setting is not selected, disabled or disconnected.
	To open a drop-down list.
	To increase a setting value.
	To decrease a setting value.
	To go back step by step.
	To go forward step by step.
	To change a setting value with the scrolleable button without adjusting.

### Sound settings

Accessing the sound settings: press 

#### Sound

In the sound settings there may be the following functions, information and setting options:

- Equaliser.
- Position.
- Settings.

### System settings

Accessing the system settings: press  Settings.

In the system settings there may be the following functions, information and setting options:

- Screen.
- Time and date.
- Language.
- Additional keypad languages.
- Units.
- Voice control.
- Wi-Fi.
- Data connection.
- Manage mobile devices.
- Reset factory settings.
- System information.
- Copyright.
- Configuration wizard.

### Adjust the volume of external audio sources

If you need to increase the playback volume for the external audio source, first lower the volume on the infotainment system.

If the sound from the connected audio source is **very low**, increase the **output volume** on the external audio source. If this is not enough, change the **input volume** to **medium** or **high**.



If the sound from the connected external audio source is **too loud or distorted**, lower the **output volume** on the external audio source. If this is not enough, change the **input volume** to **medium** or **low**.

## Clean the screen

Remove persistent dirt carefully and without using aggressive cleaning products. To clean the screen we recommend that:

- The infotainment system is switched off.
- Use a clean, soft cloth dampened with water»» page 317.
- In case of persistent dirt: soften the dirt by moistening with a little water. Then carefully remove with a clean, soft cloth.

### ⚠ CAUTION

Cleaning the screen with inappropriate cleaning products or when dry, may damage it.

- When cleaning, only press lightly.
- Do not use aggressive cleaning products or that contain solvents. Such products may damage the equipment and “darken” the screen.

## Trademarks, licenses and copyrights

### Registered trademarks and licenses

Certain terms in this manual bear the symbol ® or ™. These symbols indicate that it is a trademark or a registered trademark. The absence of this symbol, however, does not necessarily mean that the term in question can be used freely.

Other product names are registered trademarks or trademarks of the respective rights holders.

- Manufactured under license from Dolby Laboratories. Dolby and the double-D symbol are trademarks of Dolby Laboratories.
- Manufactured under license from Dolby Laboratories. Dolby and the double-D symbol are trademarks of Dolby Laboratories.
- Android Auto™ is a trademark of Google Inc.
- Apple CarPlay™ is a trademark of Apple Inc.
- Bluetooth® is a registered trademark of Bluetooth® SIG, Inc.iPod®, iPad® and iPhone® are trademarks of Apple Inc.
- MirrorLink™ and MirrorLink Logo are certified trademarks of Car Connectivity Consortium LLC.

- Windows® is a registered trademark of Microsoft Corporation, Redmond, USA.
- MPEG-4 HE-AAC audio coding technology and patents are licensed by Fraunhofer IIS.
- This product is protected by certain Microsoft Corporation industrial and intellectual property rights. The use or commercialization of technology of this type outside the configuration of this product, without a license from Microsoft or an authorised Microsoft branch is prohibited.

### Copyright

As a general rule, audio and video files stored on data media and audio sources are subject to intellectual property protection in accordance with the national and international provisions applicable in each case. Please bear in mind all legal provisions!

## Technical data

### Central computer with control and display unit

The factory-mounted central computer in the vehicle includes country-specific components and software for connectivity and for the execution of vehicle, comfort and infotainment functions.



The corresponding indications are shown on the control and display unit screen and partly on the instrument panel.

- Capacitive colour screen:
- Using the equipment with:
  - Touch zones Touch operation.
  - Buttons on the multifunction steering wheel.
  - Approach sensors (driver and passenger side recognition, gesture control).

### Vehicle and comfort functions

- Driver assistance system settings.
- Heating and air conditioning settings.
- Lights and visibility function settings.
- Vehicle comfort settings.
- Parking and manoeuvring settings.

### Sound system

#### Basic equipment:

The infotainment system that is supplied from the factory is equipped as follows:

- Speakers in different locations and with different power levels (watts).
- Internal amplifier depending on the system:
  - 4 speakers: 2 x 20 W
  - 8 speakers: 4 x 20 W

- Setting options:
  - Equaliser, depending on the system:
    - 4 speakers: treble, mid and bass.
    - 8 speakers: 5 frequency bands or pre-defined settings.
  - Sound distribution, depending on the system:
    - 4 speakers: Balance (left / right)
    - 8 speakers: Balance + Fader (left / right / front / rear).
  - Sound optimisation by zones (valid for the 8 speaker system):
    - Manual (Driver and All)
    - Automatic depending on the seats occupied.

#### Optional sound system

The infotainment system can be extended with an optional sound system as follows:

- 10 speakers in different locations and with different power levels (watts).
- External amplifier (340 W Ethernet), which processes the audio signals sent by the central computer.
- Excitation of speaker channels through class AB final stages.
- Audio signal processing in digital internal signal processor (DSP).
- Independent subwoofer in the luggage compartment.
- Setting options:

- User equaliser: 5 bands.
- Sound distribution: Balance + Fader (left / right / front / rear).
- Sound optimisation by zones:
  - Manual (Driver, Front and All)
- Subwoofer volume.
- Surround settings.

### Connectivity

#### Wi-Fi

- Wi-Fi conforming to IEEE 802.11 b/g/n
- 2.4 GHz and 5 GHz transfer (depending on the country)
- Two Wi-Fi modes at the same time:
  - Tethering.
  - Access point.
- Simultaneous connection of up to 8 Wi-Fi devices.
- Internet connection via Wi-Fi:
  - Tethering through the customer's phone.
  - Access point for customers in the vehicle.
- Apple CarPlay and Android Auto over Wi-Fi.
- Pairing process simplified by WPS or QR code.



### Bluetooth® profiles

There can be a maximum of two mobile devices connected to the Bluetooth® hands-free and a third device connected to the Bluetooth® as a music player.

When a mobile phone is connected to the telephone management system, a data exchange takes place via one of the Bluetooth® profiles.

- **Hands-free telephone profile (HFP):** the HFP can be used to manage calls through the infotainment system.
- **Audio profile (A2DP):** This profile allows audio to be transmitted with stereo quality. It may require connecting other profiles for managing and controlling playback.
- **Phone book access profile (PBAP):** Allows phone book contents to be downloaded from the mobile telephone.
- **Message profile (MAP):** It allows short messages (SMS) and emails to be downloaded and synchronised.

## Data transfer

### CUPRA CONNECT

#### Introduction



To use it, CUPRA CONNECT must first be activated online by entering into a CUPRA CONNECT contract with SEAT, S.A. and is subject to a temporary use limitation depending on the country.

Both the CUPRA CONNECT service portfolios offered by CUPRA and individual services can be modified, cancelled, deactivated, re-activated, renamed and extended, even without prior notification.

You can create the user account, see the description of services and more information at myCUPRA.com.

The execution and availability of the CUPRA CONNECT services and service portfolios may vary depending on the country, as well as the vehicle, its equipment and connectivity.

#### Connectivity statuses

 (white)	Full connectivity, all services active
 (grey)	Limited connectivity, some services may not be available.
no icon	No connectivity, no services available.

CUPRA CONNECT's voice recognition or search technology does not recognise or offer results for all words.

There are CUPRA CONNECT services for which registration is mandatory and others for which it is not mandatory.

#### Description of services

Before running CUPRA CONNECT services, read and take into account the description of the corresponding services. Descriptions are updated from time to time and are available online at myCUPRA.com.

- Always use the most up-to-date version of the corresponding service description.

#### WARNING

**In areas with insufficient mobile phone and GPS coverage, neither emergency calls or phone calls can be made, and data cannot be transmitted. Change location if possible.**

#### CAUTION

**The vehicle may be damaged by factors outside CUPRA's control. These may be specifically:**

- Misuse of mobile terminals
- Data loss during transmission.
- Unsuitable or defective third party applications.

- Malicious software on data storage devices, computers, tablets or mobile phones.

#### Services portfolio

The initial service allocation shown here corresponds to the third generation of CUPRA CONNECT services and represents the maximum services portfolio. The maximum possible portfolio is only available on some vehicle models. During the useful life of the vehicle, you can change the assignment shown here.

After activating the services management in the infotainment system you can check if the vehicle has services and what they are.

In some countries and in the event of a contract renewal, the services offered may be combined differently than indicated here. They may also vary depending on the year of production of the vehicle. The aforementioned services correspond to the third generation of CUPRA CONNECT.

#### CUPRA CONNECT services and functions that do not require activation

The following services also work without activating CUPRA CONNECT:

- Public emergency call service.
- Privacy mode»»» page 165.



- Legal.
- Customisation.
- Activating CUPRA CONNECT.
- Private mode (deactivation of services).
- Delete user / Restore factory settings.

### CUPRA CONNECT services

The CUPRA CONNECT services are:

- Private emergency call
- Public emergency call
- Roadside assistance call
- Customer support
- Service appointment planning
- Online system update
- Customisation
- Activating CUPRA CONNECT
- Private mode (deactivation of services)
- Delete user / Reset factory settings
- Remote independent heating
- Remote opening
- Horn and turn signals
- Vehicle status incl. doors and lights
- Driving data
- Vehicle status report
- Anti-theft alarm warning
- Zone warning
- Speed warning

- Online map update
- Search for points of interest
- Petrol stations
- Online traffic information
- Parking lots
- Online infotainment system update
- Online route calculation
- Information on risks
- Dictation
- Natural voice control for destinations and addresses
- Online radio
- Online media
- Online route import
- Online destination import
- Remote auxiliary ventilation
- Parking position
- Privacy mode
- Legal

### CUPRA CONNECT services for hybrid vehicles

Available only in electric and hybrid vehicles.

- Remote air conditioning
- Electrical power manager
- Departure times

- plus all CUPRA CONNECT services in the previous section»» page 162 .

### CUPRA CONNECT individual options

- In-Car Applications. These applications can be purchased and installed directly in the infotainment system through the In-Car store.
- Full Link.
- Data package. Pay per use data rates for the use of online functions, for example, 2 GB per month.

#### Note

- **The public emergency call service is available regardless of whether the infotainment system is logged in.**
- **Customisation and purchase of In-Car applications requires logging into the infotainment system, but it is not necessary to activate the vehicle in a CUPRA CONNECT account.**

## Activating CUPRA CONNECT and S-PIN

### Activating CUPRA CONNECT

The following steps are necessary to activate CUPRA CONNECT (including registration):

- Create a user account at myCUPRA.com or directly through the infotainment system in the User Management menu.
- Place the CUPRA CONNECT order and activate it.
- Add the vehicle to your user account.
- Prove ownership.
- Prove your identity. It is only necessary if you are to run CUPRA CONNECT services relevant to security.
- You can activate it at myCUPRA or directly through the infotainment system. To activate it through the infotainment system, proceed as follows: **HOME > Manage users > Become primary user**.

Follow the rest of the indications and the information shown in the infotainment system. During activation, you may be asked to create an S-PIN.

#### Update option

Infotainment	yes
CUPRA CONNECT website	yes
CUPRA CONNECT application	yes

More information at [myCUPRA.com/faqs](https://myCUPRA.com/faqs)

#### S-PIN

The S-PIN is a sequence of several digits, which can be selected when the CUPRA CONNECT registration is completed.

When creating the S-PIN, avoid easy-to-guess number sequences and known dates of birth. You can change the S-PIN in the CUPRA CONNECT user account in "Account settings".

The S-PIN is necessary, for example, to protect your user profile or to run a CUPRA CONNECT service relevant to the security of your vehicle.

You must manage this S-PIN with absolute confidentiality. If you reveal the S-PIN to third parties, for security reasons you must change it immediately.

### Ownership and identity accreditation

#### Become primary user

To become a main user and thus prove ownership of the vehicle, you need both of the vehicle's physical keys. Ownership accreditation takes place in the vehicle during registration or, if you already have a CUPRA CONNECT user account, you must log in through the infotainment system and then go to **Manage users**

- Switch on the ignition and the infotainment system.
- In the infotainment system, register in CUPRA CONNECT.
- **Or:** open the menu **Manage users > Settings > Become primary user** and follow the instructions.
- Press the unlock button on the first vehicle key.
- Press the unlock button on the second vehicle key.

Once the infotainment system has processed the orders by radiofrequency, the accreditation of the ownership will have been completed. You can control the current status on the CUPRA CONNECT website.

#### How is ownership accredited?

Infotainment	2-Key method.
CUPRA CONNECT website	No, it is not possible
CUPRA CONNECT application	No, it is not possible

#### Identity accreditation (SEAT Ident)

Identity accreditation must be completed before you can use CUPRA CONNECT services that are relevant to security, such as the »

“Remote Opening” service. Identity accreditation is done at the specialised CUPRA dealer or any SEAT dealership.

You can find more information about SEAT Ident on the CUPRA CONNECT website at [myCUPRA.com](http://myCUPRA.com).

### Legal provisions

When using CUPRA CONNECT services, information is transferred and processed online through the vehicle. Such data can also provide (at least indirectly) information about the driver in question, for example, driving behaviour and location. As a contracting party in the CUPRA CONNECT contract with SEAT, S.A., you must ensure that when your vehicle is used by other drivers (for example, family or friends), data protection and personal rights are respected. Therefore, you must inform drivers in advance that the vehicle transfers and receives data online, and that you can access such data.

Not taking into account this obligation to inform, can infringe certain rights of the occupants.

Users can manage data sending and transfers through the privacy mode at any time. For more information visit: [myCUPRA.com/faqs](http://myCUPRA.com/faqs)

### Follow-up services: ask all occupants

The follow-up services need geographical and vehicle data to determine whether the vehicle is being used within defined speed ranges, where it has been parked or if it is being used in an established geographical area. This information is displayed on the CUPRA CONNECT website and in the CUPRA CONNECT app.

Therefore, before moving off, ask all the vehicle occupants if they agree with the activated services. If they do not, deactivate the service in question (if possible) or do not allow the occupants to use the vehicle.

### GPS tracking: marking

If the vehicle has a factory-assembled control unit that transmits the its current geographical position and speed, the vehicle usually has this GPS marking (e.g., on the roof console). The absence of the marking on the vehicle does not guarantee that the control unit does not transmit the vehicle's current geographical position and speed.

### Personal information

CUPRA protects your personal data and only uses them, as long as the law allows it or you have given your consent on the occasion of a use. You will find detailed information on data processing in relation to CUPRA CONNECT services in the Privacy Policy, which

you can access in its corresponding current version on the CUPRA website.

### Permanent transfer of the vehicle

If another person has left you the vehicle for permanent use (for example, if you buy a used vehicle), CUPRA CONNECT may already be activated and the previous user may still be able to access the data registered through CUPRA CONNECT and control certain functions of your vehicle.

In the infotainment system you can check if your vehicle is assigned to a person as the main user. In this case, you can register yourself as the main user of the vehicle and thus automatically delete the previous main user. Alternatively, through the infotainment system you can directly and permanently delete the previous user as the main user, as well as put the vehicle in offline mode and thus limit both the communication of your vehicle with the SEAT, S.A. data server and the processing of personal and vehicle data.

### Deactivating CUPRA CONNECT services

The following functions are available in the infotainment system to deactivate and activate CUPRA CONNECT services:

- Central deactivation or activation

- Individual deactivation or activation

You can rerun the corresponding services after cancelling their deactivation in the infotainment system.

#### Note

**The services required by law and their data transmission, such as the public emergency call system, cannot be disconnected or deactivated.**

### Faults

Even if the prerequisites for the use of CUPRA CONNECT services are met, there may be factors beyond the control of CUPRA that interfere with the execution of such services or prevent them. These may be specifically:

- Maintenance, repair, deactivation, software update and technical expansion of telecommunication equipment, satellites, servers and data banks.
- Change of the mobile telephony standard for the transmission of mobile data by the telecommunications service provider, for example, from UMTS to EDGE or GPRS.
- Disconnection of an existing mobile phone standard by the telecommunications service provider.

- Interference, disturbance or interruption in the reception of the mobile phone and GPS signal due to aspects such as high-speed driving, solar storms, meteorological influences, topography, blocking equipment and the intensive use of mobile phones in the radio cells in question.

- When in areas with zero or insufficient mobile telephony or GPS signal. Also, for example, in tunnels, confined areas between very tall buildings, garages, underpasses, mountains and valleys.
- External information from third party supplies available with limitations, incomplete or incorrect, e.g. representations of maps.
- Countries and regions where CUPRA CONNECT is not offered.

### Service management

It can be accessed from **Users > Settings > Private Mode (deactivation of services)** and you can do the following in Infotainment:

- Check which CUPRA CONNECT services are currently available in the vehicle.
- The number of CUPRA CONNECT services that are activated or deactivated.
- Activate or deactivate CUPRA CONNECT services.





Find out more information at: [myCUPRA.com](http://myCUPRA.com).

### Privacy and Services Settings

CUPRA CONNECT services can be activated and deactivated individually. To do this, just check the box corresponding to the service you want to activate or deactivate. Use the privacy mode option if you want to deactivate all of the services at the same time.

#### Privacy mode

Allows you to deactivate or activate the services depending on the selected privacy level.

 Tracking	<b>Share location.</b> Main users and co-users can view position data on the CUPRA CONNECT portal or app.
 Location	<b>Use location.</b> Position, vehicle, and user data are used for services.
 Personal	<b>No location.</b> Only the vehicle data and user data are used for services.
 Incognito	<b>Maximum privacy.</b> Your services are disabled. Only services required for legal reasons use data.

Setting options are not available in all markets or in all vehicle models. »

**Note**

If you deactivate all CUPRA CONNECT services, the OCU may continue to transmit data.

## Full Link

### Introduction

With Full Link it is possible to view and use the contents and functions that are shown on the mobile phone device on the infotainment screen.

To do this, the mobile phone device must be connected with the infotainment system through a USB interface.

Some technologies can also be used by Wireless Full Link through the Bluetooth® interface and a Wi-Fi connection.

**The following technologies may be available:**

- Apple CarPlay™
- Apple CarPlay™ Wireless
- Android Auto™
- Android Auto™ Wireless
- MirrorLink®

The availability of the technologies that Full Link includes depends on the country and the mobile phone device used.

You can find more information on the CUPRA website.

#### Access the Full Link main menu

Browsing the Full Link main menu depends on the infotainment system used.

- Click on  **Full Link**.

#### Configure Wireless Full Link

In order to use Wireless Full Link, you must first pair the mobile phone device with the infotainment system. To do this, proceed as follows:

Connect a mobile phone device for the first time.

- Unlock the mobile phone device.
- Enable Wi-Fi reception and Bluetooth® on the mobile phone device.
- Connect the mobile phone device to the infotainment system using a USB cable or via Bluetooth®.
- Access the Full Link main menu, unless it appears automatically.
- Select the mobile phone device and the technology you want.

- Confirm authorisation inquiries on the mobile phone device to grant the necessary authorisations to the infotainment system.

- Disconnect the USB connection and connect with the infotainment system again via Wi-Fi or Bluetooth®. Wireless Full Link is now configured.

The pairing has concluded. The connected mobile phone device can also use Wireless Full Link from now on without the USB connection.

If pop-up menus are rejected during the connection process, Wireless Full Link will not be available. In this case, CUPRA recommends removing the devices in both the telephone settings and the infotainment system, and restarting the connection process.

#### WARNING

**The use of applications while driving can distract your attention from the traffic. Any distraction affecting the driver in any way can lead to an accident and cause injuries.**

- Always drive as carefully and responsibly as possible.

#### WARNING

**Any applications that are not suitable or execute incorrectly may cause damage to the vehicle, accidents and serious injuries.**



- Protect the mobile phone device and its applications from inappropriate use.
- Never carry out modifications to the applications.
- Follow instructions in the instruction manual for the mobile phone device.

### ⓘ CAUTION

CUPRA cannot be held liable for any damage caused to the vehicle as a result of the use of applications that are of poor quality or are defective, the inadequate programming of the applications, the insufficient coverage of the network, the loss of data during transmission or the improper use of mobile phone devices.

### ℹ Note

- Wireless Full Link may not be compatible with all technologies.
- Wireless Full Link (Android Auto™ and Apple CarPlay™) is disabled in countries whose radio frequency regulations do not allow it to operate.

## Applications (apps)

With Full Link, the display of the contents of CUPRA applications and other providers installed on mobile phone devices can be transferred to the infotainment screen.

In the case of third-party applications, there may be compatibility problems.

Applications, their use and the necessary mobile phone connection may be pay per use.

The offer of applications can be varied and designed for a vehicle or a specific country. The content and volume of applications, as well as the companies that offer them, may vary. Some applications also depend on the availability of third-party services.

It cannot be guaranteed that all the applications offered will work on all mobile phone devices or with all their operating systems.

The applications offered by CUPRA can be modified, cancelled, deactivated, reactivated and extended without prior notification.

To avoid distracting the driver while driving, only certified applications can be used.

## Full Link symbols and settings

- ℹ To show more information
- ⚙ To open the Full Link settings menu
- 📱 To select Apple CarPlay technology.
- 📶 To select Android Auto™ technology.
- 📺 To select Mirror Link® technology.

## Apple CarPlay™

In order to use Apple CarPlay, the following requirements must be met:

- The iPhone™ **must** be compatible with Apple CarPlay™.
- Voice control (Siri™) **must** be active on the iPhone™.
- Apple CarPlay™ **must** be active without limitations in the iPhone™ settings.
- The iPhone™ **must** be connected to the infotainment system via a USB connection. Only USB connections with data transmission are suitable for the use of Apple CarPlay™.
- The USB cable used **must** be an original Apple™ cable.

*Apple CarPlay™ Wireless:* Bluetooth® and Wi-Fi must also be activate on the iPhone™.

### Establish connection

When you first connect an iPhone™, follow the instructions on the infotainment system screen and on the iPhone™.

The requirements must be met to use Apple CarPlay™.

Launch Apple CarPlay™:

- Press  **Full Link** to access the Full Link main menu. »

- Press Apple CarPlay™ to establish a connection with the iPhone™.

### Disconnecting

- In Apple CarPlay™ mode, press the CUPRA icon to access the Full Link main menu.
- Press X to interrupt the active connection.

The representation of function buttons on the screen may vary.

### Special characteristics

During an active Apple CarPlay™ connection, the following characteristics are applicable:

- Bluetooth® connections between the iPhone™ and the infotainment system are not possible.
- If there is an active Bluetooth® connection, it is automatically interrupted.
- The phone functions are only available through Apple CarPlay™. The functions described for the Infotainment system are not available.
- The connected iPhone™ cannot be used as a multimedia device in the Media main menu.
- It is not possible to use the built-in navigation system and the Apple CarPlay™ navigation system at the same time. The last route started interrupts the one that was previously active.

- Depending on the infotainment system you use, on the instrument panel screen you can view data from the Telephone and Media mode.

- With the multifunction steering wheel you can accept or reject incoming calls, as well as end an ongoing telephone conversation.

### voice control

- Press  briefly to start voice control using the infotainment system.
- Press this button for a long time to start voice control (Siri™) of the connected iPhone™.

#### Note

- **The availability of technologies depends on the country and may vary.**
- **You will find information about technical requirements, compatible iPhones, certified applications and their availability on the CUPRA and Apple CarPlay™ websites, at specialised CUPRA dealers/SEAT network dealers.**

## Android Auto™

### Requirements for Android Auto™

In order to use Android Auto™, the following requirements must be met:

- The mobile phone device, called smartphone from here on, has to be compatible with Android Auto™.
- The smartphone must have an Android Auto™ application installed.
- The smartphone has to be connected through the USB connection with data transmission with the infotainment system.
- The USB cable used must be an original cable provided by the smartphone manufacturer.

*Android Auto™ Wireless:* Bluetooth® and Wi-Fi also have to be activated on the device.

### Establish connection

When you first connect a smartphone, follow the instructions on the infotainment system screen and on the smartphone.

The requirements must be met to use Android Auto™.

Launch Android Auto™:

- Press  **Full Link** to access the Full link main menu

- Press Android Auto™ to establish a connection with the smartphone.

### Disconnecting

- In Android Auto™ mode, press the **Exit/SEAT** icon to access the Full Link main menu.
- Press X to interrupt the active connection.

### Special characteristics

During an active Android Auto™ connection, the following characteristics are applicable:

- An active Android Auto™ device can be connected at the same time via Bluetooth® (HFP profile) with the infotainment system.
- It is possible to use the phone's functions through Android Auto™. If the Android Auto™ device is connected at the same time via Bluetooth® with the infotainment system, the telephone function of the infotainment can also be used.
- An active Android Auto™ device **cannot** be used as a multimedia device in the Media main menu.
- It is **not** possible to use the built-in navigation system and the Android Auto™ navigation system at the same time. The last route started interrupts the one that was previously active.

- On the instrument panel screen you can view data from the Telephone and Media mode.
- With the multifunction steering wheel you can accept or reject incoming calls, as well as end an ongoing telephone conversation.

### voice control

- Press  briefly to start voice control using the infotainment system.
- Press and hold this button to start voice control (Google Assistant) on the connected smartphone.

#### Note

- **The availability of technologies depends on the country and may vary.**
- **You will find information about technical requirements, compatible mobile phone devices, certified applications and their availability on the CUPRA and Android Auto™ websites, at specialised CUPRA dealers/SEAT network dealers.**

### MirrorLink®

#### Requirements for MirrorLink®

In order to use MirrorLink™, the following requirements must be met:

- The mobile device must be compatible with MirrorLink™.

- The mobile phone device must be connected to the infotainment system via a USB connection that is suitable for data transmission.
- The USB cable used must be an original cable provided by the mobile phone device manufacturer.
- Depending on the mobile phone device used, a Car-Mode application that is suitable for using MirrorLink® must be installed.

### Establish connection

When you first connect a mobile phone device, follow the instructions on the infotainment system screen and on the mobile phone device.

The requirements must be met to use MirrorLink™.

Launch MirrorLink®:

- Press  **Full Link** to access the Full Link main menu.
- Press to establish the connection with the mobile phone device.

### Disconnecting

- In the MirrorLink® mode, press the **APP** icon to access the Full Link main menu.
- **OR:** press  to access the MirrorLink® main menu.
- Press X to interrupt the active connection. »

## Special characteristics

During an active MirrorLink® connection, the following characteristics are applicable:

- An active MirrorLink® device can be connected to the infotainment system at the same time via Bluetooth®.
- If the MirrorLink® device is connected to the infotainment system via Bluetooth®, the telephone function of the infotainment system can be used.
- You cannot use an active MirrorLink® device as a multimedia device in the Media main menu.
- On the instrument panel screen you can view data from the Telephone mode.
- The instrument panel screen does not display any indication to turn on the Media mode.
- With the multifunction steering wheel you can accept or reject incoming calls, as well as end an ongoing telephone conversation.

## Function buttons

Function buttons and their function:

- APP** Return the Full Link main menu. Here you can end the MirrorLink® connection, connect another mobile phone device or select another technology.
- X** Press to close the open apps. Then press the apps to be closed or the **Close**

**all function button** to close all the open applications.



Press to display the mobile phone device screen on the infotainment system screen.



To open the MirrorLink® settings.



Press to return to the MirrorLink® main menu.

### Note

You will find information about technical requirements, compatible mobile phone devices, certified applications and their availability on the CUPRA and MirrorLink® websites, at specialised CUPRA dealers/SEAT network dealers.

## WLAN access point

### Introduction

✓ Not available on vehicles without CUPRA CONNECT and without navigation

The infotainment system can be used to share a WLAN connection with up to 8 devices»» page 170, Configuration for sharing a connection over WLAN.

The infotainment system can also use the WLAN hotspot of an external device to pro-

vide Internet to the devices connected to the hotspot (WLAN client)»» page 171.

### Note

- **Data transmission may incur charges.** Due to the high volume of data exchanged, CUPRA recommends the use of a flat rate tariff for data transmission. Mobile phone operators can provide the relevant information.
- The exchange of data packages may generate additional costs, depending on your mobile phone rate, particularly if you are abroad (for example, roaming rates).

## Configuration for sharing a connection over WLAN

Establishing the connection with the wireless network (WLAN)

- Press the **Settings** button.
- Activate the wireless network. To do this, press the function button **Wi-Fi > Infotainment system as hotspot**.
- Activate the wireless network (WLAN) on the device that is to be connected. If necessary, refer to the manufacturer's instruction manual.
- Activate the mobile device assignment in the infotainment system. To do this, press

the function button **Enable as hotspot** and check the checkbox.

- Enter and confirm the network key displayed on the device.

The following adjustments can also be made in the **Infotainment system as hotspot** menu:

- **Security level:** WPA2 encryption automatically generates a network key.
- **Network key:** Network key automatically generated. Press the function button to manually change the network key. The network key must have a minimum of 8 characters and a maximum of 63.
- **SSID:** WLAN Network name (maximum of 32 characters).

The wireless (WLAN) connection is established. To complete the connection, it may be necessary to enter other data into the device.

Repeat this process to connect other devices.

There is also the option of scanning the QR code by connecting the device directly to the infotainment system's Wi-Fi network without having to enter the password: select **Settings > Wi-Fi > Quick connection to infotainment system**.

## Wi-Fi Protected Setup (WPS)

✓ This depends on the equipment and the country in question.

*Wi-Fi Protected Setup* can be used to create a ciphered local wireless network quickly and simply.

- Establish the connection with the wireless network (WLAN).
- Press the WPS button on the WLAN router until the warning light on the router starts flashing. If the WLAN router does not support WPS the network must be configured manually.
- **OR:** Press and hold the WLAN button on the WLAN router until the WLAN light on the router starts flashing.
- Press the WPS button on the WLAN device. The wireless (WLAN) connection is established.

Repeat this process to connect other devices.

## Configure Internet access

The infotainment system can use the WLAN hotspot of an external device to establish an Internet connection.

## Establishing the connection with the wireless network (WLAN)

- Activate and check the wireless hotspot on the external device. If necessary, refer to the manufacturer's instruction manual.
- Press the  **Settings** button; **OR** access the *Media* and press the **Settings** menu.
- Press the **Wi-Fi > Connect to Wi-Fi** menu and put a check in the checkbox.
- Press the **Search for Wi-Fi** button and select the device you want from the list.
- If necessary, enter the network key of the device in the infotainment system and confirm with **OK**.

### Manual settings:

- To manually enter the network settings of an external (WLAN) device.

The wireless (WLAN) connection is established. To complete the connection, it may be necessary to enter other data into the device.

### Note

**Due to the large number of devices on the market, it is not possible to guarantee fault-free operation of all functions.**

# Infotainment operation

## voice control

### Introduction

Voice control works both online and offline. In online mode, commands are recorded more accurately, as more data is available.

Voice control understands questions and expressions without having to learn commands. Commands can be formulated freely and can be colloquial. You will find proposals for commands in the infotainment system.

Functions are reduced in offline mode.

Loud noises inside or outside the vehicle can cause malfunctions, as well as confusing phrases and answers.

### Languages available depending on the market

*Online and offline:* German, American English, British English, French, Italian, Spanish and Czech. These languages have advanced functions such as Online Commands, natural interaction, etc.

The other languages of the infotainment system **do not** offer Online Commands, air conditioning control or natural interaction.

### Requirements

- *Online and offline:* voice control with the corresponding infotainment installed in the vehicle.
- *Online* current active CUPRA CONNECT Plus contract.

#### Note

- **Voice control only recognises commands in the language that is set in the infotainment system.**
- **Test the voice control with the vehicle stopped before starting to move to familiarise yourself with its operation.**
- **Additional information and examples can be found in the menu Home > Help > Voice control**

### Wake word and commands

#### Voice control wake words

If you have connected the voice control via the wake word, the connected infotainment responds with **How can I help you?**. It then scans the words spoken in the vehicle after the wake word.

Voice control starts when the infotainment recognises the wake word.

#### Connect and disconnect the wake word

- Press  **Settings > Voice control > Activate/deactivate wake word.**

Wake word:

Hola Hola

#### Commands

For voice control to recognise commands reliably, bear in mind the following tips for the commands to work properly:

- Pronounce clearly. Confusing commands are not recognised. Speak in a normal tone of voice. Speak a little louder if you are driving at high speed.
- Avoid outside noises. Open windows and doors can interfere with voice control.
- Avoid other secondary noises, such as conversations in the vehicle. Do not direct the air flow from the outlets towards the microphone or the interior lining of the roof.
- Do not use a very strong accent or dialectal.
- Do not make long pauses.



Voice control is active and recognises the words pronounced.

#### Note

- **When the activation word is disconnected, the infotainment system cannot be activated by means of the activation word.**

Voice control is still available via the  button on the multifunction steering wheel.

- Availability depends on the country and equipment.
- Depending on the content of the phone book and to ensure reliable recognition of the names of the phone book, it may be useful to change the order of the first and last name of the contact in question.

### Start and stop voice control

Depending on the equipment, you can start voice control in different ways.

#### Start voice control

- *Voice control activation*: say the word that activates voice control.
- *Multifunction steering wheel*: press the voice control button .

The voice control ends automatically, if you use infotainment functions, if the parking system is activated or by incoming calls.

In some cases you can also start voice control of the connected mobile phone device, by pressing and holding the voice control button.

#### Manually ending voice control

Voice control can be cancelled with the **Cancel** command.

- *Multifunction steering wheel*: press the voice control button  twice in a row, or a long press.

## Radio mode

### Introduction

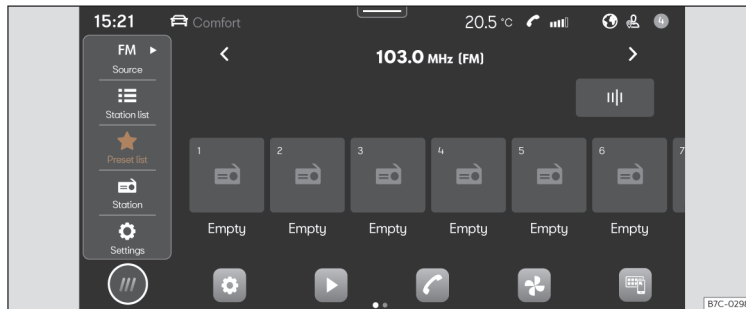

Fig. 127 Schematic representation: Radio view

In Radio mode you can tune in the available radio stations in different frequency bands and memorise your favourites on the preset buttons to access them quickly.

The types of reception and frequency bands available depend on the equipment and the country. In certain countries, frequency bands may stop broadcasting or not be available again.

#### Access the RADIO menu

- Press **HOME** > >>> **Fig. 127**.

#### Access the settings

- Press **HOME** > > .

#### Online functions in Radio mode

Online functions in Radio mode are only available under the following conditions:

- CUPRA CONNECT or CUPRA CONNECT Plus equipment.
- You have an active CUPRA CONNECT user account.
- Add the vehicle is assigned to your user account.

- You have a corresponding data package acquired from the In-Car store or have a data volume for your own mobile phone device via Wi-Fi access point.

#### Note

- **For streaming services you need to have an account with the provider in question.**
- **Radio stations are responsible for the content of the information they transmit. Additional electrical equipment connected to the vehicle can cause interference in the reception of the radio signal and noise in the speakers.**



- Foil or metal-coated stickers attached to the windows may affect reception on vehicles with a window aerial.

### Radio equipment and symbols

The functions, as well as the types of reception and frequency bands available depend on the equipment and the country.

- AM tuner.
- Dual FM receiver (diversity antenna).
- Summarised FM station list.
- Fusion of DAB and FM stations into one list.
- Fusion of all stations stored in preset buttons into one list. Maximum 36 favourite stations.
- Station logos.
- DAB presentation (slideshow). Images that are emitted sequentially.
- Internet radio.

#### Universal symbols in Radio mode

**AM** To select the desired AM frequency band.

**FM/DAB** To select the desired FM/DAB frequency band.

**Online radio** To select the type of Internet radio reception.

**TP** Next to the name of the station, monitoring of active traffic information stations (TP).

#### Symbols on the FM/DAB frequency band

To display the frequency band for manual selection of the FM frequency. Only possible when the summary station list is disconnected.

DAB not available.

DAB stations support presentations (slideshow).

#### Symbols on the AM frequency band

Manually updating the station list.

To display the frequency band for manual selection of the AM frequency.

#### Menus in Internet radio mode

Show station selection.

Open text search.

Show the last online radio stations heard.

Show the 100 most played radio stations and podcasts.

Show available online radio podcasts.

Show online radio stations, grouped by country.

Show online radio stations by the desired language.

Show online radio stations whose programme belongs to the desired musical genre.

### Selecting, tuning and saving a station

#### Select the frequency band

Before selecting a station you have to select a frequency band or a type of reception. Different stations are available depending on the frequency band selected or the type of reception.

The types of reception and frequency bands available depend on the equipment and the country.

- Select the frequency band or type of reception: AM, FM/DAB, FM (for devices that do not have DAB), Internet radio.

#### Search and select a station

You can select radio stations in different ways. The options vary depending on the frequency band and the type of reception.

#### Select via the frequency band (AM and FM)

- Activate the frequency band.
- Click on the cursor, scroll through the frequency band and release it when you reach the frequency band you want. »

- **OR:** press on a point on the frequency band. The cursor will automatically jump to the corresponding frequency.

The station of the set frequency is tuned.

### Select from the station list (AM and FM/DAB)

The station list shows the stations that are currently tunable. In the AM frequency band, you may have to update the station list if you are no longer in the area where you last accessed the station list. In the FM/DAB frequency band, the station list is automatically updated.

- Open the station list
- Press the station you want.

The selected station is tuned. In the case of FM/DAB and if the station is available, the best quality reception is automatically selected.

### Search and filter stations (Internet radio)

In Online Radio mode, stations can be filtered by categories and can be searched by text.

- Open the station list.
- Select the category by which the stations are to be filtered.

- **OR:** press  $\mathcal{Q}$  to start the text search. The input field is displayed.
- Enter the name of the station you want. The list of the stations found is updated while entering the text.
- Press the station you want.

The selected station is tuned.

### Search in SCAN mode (AM and FM/DAB)

In SCAN mode the stations are automatically tuned in a sequential manner and each of them is played for approx. 5 seconds.

- To start the SCAN mode, under **Settings** press **SCAN**.

SCAN mode starts and the station currently tuned in is shown on the screen. Next to it is a SCAN function button.

- To select a station press SCAN.

SCAN mode stops and the station is tuned. The SCAN function button is hidden.

### Storing the station on the preset buttons

You can store up to 36 stations of different frequency bands and reception types as favourites using the preset buttons.

- Tune the station you want.
- Access the preset buttons.

- Press the preset button and keep it pressed until the station is stored.
- **OR:** press the station on the station list and keep it pressed. The preset buttons are displayed.
- Press the preset button.

The station is stored in the selected preset button.

If a station was already stored in the preset button, it is overwritten with the new station.

## Special functions in Radio mode

### Traffic information (TP)

The TP function monitors the announcements of a station with traffic information and automatically reproduces them in the Radio mode or in the multimedia playback that is active. To do this, you have to be able to tune into a station with traffic information.

Some stations without their own traffic information support the TP function by broadcasting traffic information from other stations (EON).

In the AM frequency band or in the Multimedia mode, a station with traffic information in the background is automatically tuned while it is possible to tune into a station with traffic information.

If no station with traffic information can be tuned in, the device automatically searches for stations with tunable traffic information.

Stations with traffic information are not available in all countries.

### Activating and deactivating the TP function

- In Radio mode or Multimedia mode, press **Settings > Traffic station (TP)**.

### Online radio

Online radio is a type of reception for Internet radio stations and podcasts that are independent of AM, FM and DAB. Thanks to Internet transmission, reception is not limited to the region.

Online radio is only available through the Internet connection of the active infotainment system. The use of online radio can generate expenses due to the transmission of data from the Internet.

- In Online radio mode, press and set the audio quality to high or low to tune the online radio.

### Station logos

In the case of some frequency bands, station logos may already be pre-installed in the infotainment system.

If in the FM/DAB frequency band settings the **automatic selection of station logos** is

activated, station logos are automatically assigned to the stations.

In the Online radio mode, the infotainment system accesses the station logos of the online database and automatically assigns them to the stations

### Assign station logos manually

- In FM/DAB mode, press **Station logos**.
- Press on the  icon and then select the station to which a station logo is to be assigned.
- Select the station logo. If desired, repeat the same process with other stations.
- **OR**, via the menu **Settings > Station logos**.

## Media Mode

### Introduction

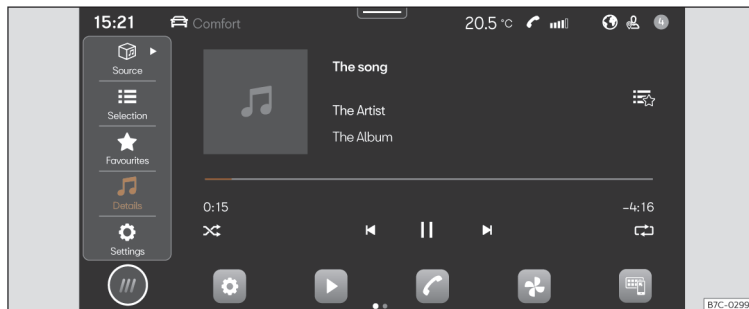

**Fig. 128** Schematic representation: Multimedia view

In Media mode you can play multimedia files from data media and streaming services through the infotainment system.

Depending on the equipment, the following data media can be used:

- USB storage support (for example, a USB stick, a mobile phone connected via USB).
- Bluetooth® device (for example, a mobile phone or a tablet).

Depending on the equipment, the following types of multimedia files can be played:

- Audio files.

- Video files (depends on the system).

You can also use streaming services. The availability of streaming services depends on the equipment and the country.

To use streaming services you need to have your own user account in the streaming service in question.

#### Access the MEDIA menu

- Press **HOME** > ► >>> **Fig. 128**.

#### Access the settings

- Press **HOME** > ► > ⚙️.

#### Limitations and indications of data media

Data media may not work if they have been exposed to high temperatures or have been damaged. Please bear in mind the manufacturer's indications.

Quality differences between data media produced by different manufacturers can cause multimedia playback malfunctions.

Incorrect configuration on a data media may cause the data media to be unreadable.

Playlists only specify a playback order and refer to the storage location of the multimedia files within the folder structure. In a playlist

there are no multimedia files saved. To play a playlist, multimedia files have to be found in the storage places of the data media to which the playlist refers.

#### Note

CUPRA assumes no liability for any deterioration or loss of files on data storage devices.

## Features of the multimedia equipment and symbols

### Audio, multimedia and connectivity:

- Multimedia playback and control via Bluetooth®.
- Audio playback in these formats: AAC, ALAC, AVI, FLAC, MP3, MP4, WMA.
- Video playback in these formats: MPEG-1 and MPEG-2 (.mpg, .mpeg), ISO MPEG4, DivX 3, 4 and 5 Xvid (.avi), ISO MPEG4 H.264 (.mp4, .m4v, .mov), Windows Media Video 10 (.wmv, .asf).
- Playlists on any type of device.
- Multimedia streaming (online).
- Multimedia search.

### Universal symbols in Media mode

- ▶ To start playback.
- || To pause playback.

- ◀ To change to the previous title.
- ▶ To change to the next title.
- 🔁 Repeat the current track.
- 🔁 Repeat all titles.
- 🔀 To activate the shuffle playback order.
- ★ To display the favourites list.
- ⊕ Add multimedia file as favourite.
- ▼ Top right: Select multimedia source.
- ⚙️ Access the settings.
- 🔍 Open the search.
- ◀ To return to the top folder of the multimedia source.

## Select and play a multimedia source

### Select multimedia source

Before playing multimedia files you must first connect a multimedia source.

To use streaming services you must be connected to the Internet.

- Connect an external multimedia source.
- Select the connected media source to be used for playback.

## Playing audio and video files

You can search and play multimedia files from an available multimedia source in different ways.

### Search in the folder structure

Multimedia files can be catalogued by categories (for example, album, artist, title). In **My media** this category view is always displayed. The classic folder structure of individual USB data media is also found in **My media**.

1. Activate the folder structure.  
The folder structure of the selected multimedia source is displayed. When **My media** is selected, the categories (music, videos, playlists) and connected multimedia sources are displayed first.
2. Search for the title you want in the folder structure.  
**OR:** press **Q** to start the text search. The input field is displayed.
3. Enter the name of the desired title. The list of the titles found is updated while entering the text.
4. Press the desired title.  
If at the beginning of the playback your selection is in a folder of a multimedia source, the multimedia files that are in it are also added to the playback. »

If a playlist is played, all available titles in the playlist are added to the playback.

5. Close your selection with X.

### Select favourites

In favourites you can save titles, music genres, artists and albums individually for playback.

- Access favourites ★.
- Press the favourite you want.

Depending on your selection, all the titles belonging to the favourite are added to the playback.

### Configure streaming services

Depending on the equipment you can use streaming services directly through the infotainment system. For this you need to have a premium user account of the streaming service in question and you have to log in with it in the infotainment system. You also need to be connected to the Internet.

1. Select  **Streaming** as the multimedia source.

A list of available streaming services is displayed.

2. Select the streaming service you want.
3. Follow the steps indicated by the infotainment system.

The streaming service is added to the list of multimedia sources as a new function button.

### Save favourites

Only multimedia files in **My media** of the infotainment system can be saved as favourites. You can save up to a maximum of 30 titles, albums, artists and music genres individually as favourites.

1. Start playback.
2. Access favourites.
3. Tap a favourite that is not assigned.  
**OR:** press on an existing favourite and hold for approx. 3 seconds.
4. Select from the selection list: Title, Album, Artist, Music genres, Playlist.

The selection is saved instead of the previously selected favourite. If the favourite was already assigned, the previously saved favourite is overwritten.

The selectable options in the selection list depend on the data attached to the multi-

media file. If the music genre is not indicated in the music files, for example, you cannot save the music genre as favourite.

If a video file is playing, only that video can be saved as favourite.

### Playing entertainment content in the infotainment system

Depending on the infotainment system, videos can be played.

### Video mode

When in video mode, a video can be played on the infotainment screen if this is stored on a data media, in **My media** or is sourced from a streaming service. In this case, the video sound is played through the vehicle's speakers.

The image is only displayed if the vehicle is stopped. When the vehicle is in motion, the infotainment screen turns off. The sound of the video can still be heard.

A stable Internet connection is required for playback from a streaming service. In this case, telephony costs may be generated.

## Navigation

### Introduction



**Fig. 129** Schematic representation: Navigation view

A global satellite system determines the current position of the vehicle and the sensors mounted on the vehicle analyse the routes taken. All measured values and possible traffic events are compared with the available maps to allow optimal navigation to the destination.

Navigation announcements and graphic representations will guide you to your destination.

Navigation management is carried out on the screen.

Depending on the country, some functions of the infotainment system will not be availa-

ble on the screen when travelling above a certain speed. It is not a malfunction, but is due to compliance with legislation.

#### Navigation announcements

Navigation announcements are acoustic indications for driving referred to the current route.

The type and frequency of navigation announcements depend on the driving situation, for example, starting the guide to the destination, driving on the motorway or on a roundabout and the settings.

If the exact destination cannot be reached because, for example, it is in a non-digitised area, indications relating to the address and the distance to the destination are displayed on the screen.

During dynamic route guidance, you will receive information about reported traffic congestion on the route. An additional navigation announcement is provided if the route is recalculated due to traffic congestion.

While a navigation announcement is playing, its volume can be adjusted. The following »

navigation announcements provided will be played with the newly adjusted volume.

### Limitations during navigation

If the infotainment system cannot receive data from GPS satellites, for example, in a tunnel or in an underground garage, navigation continues using the vehicle's sensors.

In areas that are not digitised or are only partially digitised on the infotainment memory, the infotainment system will still attempt to provide route guidance.

In the case of missing or incomplete navigation data, it may not be possible to determine the exact position of the vehicle. This may mean that navigation is not as precise as usual.

Roads and streets are subject to constant change (e.g. new roads, road works, roads closed to traffic, changes to street names and building numbers). If the navigation data is obsolete, this may lead to errors or inaccuracies during the route guidance.

### Managing the navigation map

To allow an optimal view, you can also manage the navigation map with additional finger movements.

#### Move the map *(tip: use your index finger)*.

- Move the map with your finger.

**Zoom in the view** *(tip: use your index finger)*.

- To increase the view in a certain position, double-click on the map.

**Zoom out the view** *(tip: use your index and middle fingers)*.

- Press on the map with both fingers at the same time.

**Change view** *(tip: use your index finger)*.

- Press twice on the map and keep your finger pressed on the screen.
- To zoom out the view of the map, move your finger upwards. To zoom in the view of the map, move your finger downwards.

**Change view** *(tip: use your index and middle fingers)*.

- Press on the map with both fingers at the same time and keep them pressed.
- To zoom out the view of the map, move one finger towards the other. To zoom in the view of the map, move one finger away from the other.

**Tilt the view** *(tip: use your index and middle fingers)*.

- Press on the map with both fingers at the same time and horizontal to each other, keep them pressed.
- To tilt the view of the map forward, move your fingers upwards. To tilt the view of the

map backward, move your fingers downwards.

**Rotate view** *(tip: use your index and middle fingers)*.

- Press on the map with both fingers at the same time and keep them pressed.
- To rotate the map view, turn your fingers clockwise anticlockwise.

### Saved data

The infotainment system saves certain data, for example, frequent routes and position data, to make the entry of the destination more agile and optimise the route guidance.

### Delete saved data

- Press **Settings > Basic function settings > Delete** and then **OK**

### WARNING

Select the settings, enter the destination and the modifications for navigation only with the vehicle at a standstill.

### Note

- If a detour is passed during route guidance, navigation may recalculate the route.
- The quality of the navigation recommendations given by the Infotainment system depends on the navigation data available and any reported traffic congestions.



- Navigation announcements are not emitted if the sound is muted in the infotainment system.

## Navigation functions and symbols

### Navigation

Navigation functions depend on the equipment and country.













### Functions

- Entering destination and route calculation (offline and online).
- Displaying two navigation maps at the same time (display and instrument cluster).
- Update of online maps.
- Predictive navigation.
- 3D urban maps.
- Online traffic information
- Dynamic POIs (points of interest)





### Symbols on the map

The buttons and indications depend on the settings and the current driving situation.







Symbols for traffic events and points of interest (POIs) are displayed on the map, for example, petrol stations, train stations or interesting stopovers, provided navigation has such data»» page 186 .

-  Current position
-  Search for destinations.
-  Destinations along the route.
-  Final destination
-  Home address
-  Work address
-  Favourite destinations
-  Additional window with more options.
-  Additional window with route options.
-  Centre the map on the current position.
-  Change view: 2D oriented to the north, or 2D oriented to the direction of travel, or 3D to the direction of travel.
-  Information about the current route guidance.
-  Map scale.



### Symbols in the additional window

- To open the additional window, press .
-  Repeat the last navigation announcement.
-  Volume of navigation announcements.
-  Map lighting in Automatic, Day or Night mode.
-  Offer new guidance routes.

### Other symbols

-  Entering the detailed destination for an address.
-  Search for destinations.
-  Frequent destinations.
-  Last destinations.
-  Favourite destinations
-  Back





### Symbols in the route details

-  Current position.
-  Destination of the current guidance.

### POI symbols (points of interest)

POIs (points of interest) are shown on the map, provided the navigation has said data.







Click on the desired POI (point of interest) to start a route guidance»» page 184 .

-  Petrol station.
-  Parking lot.
-  Tourist information offices.
-  Train station.
-  Restaurant.

### Traffic information.

POIs (points of interest) are shown on the map, provided the navigation has said data »» page 186 .

Click on a traffic event to open an additional window with further details»» page 186 .

-  Slow traffic.
-  Traffic jam.
-  Accident.
-  Broken down vehicle.
-  Slippery surface (ice or snow).
-  Road closed to traffic.
-  Slippery road hazard.
-  Danger.
-  Road works.
-  Strong wind.
-  Reduced visibility.

### Navigation data

The Infotainment system is equipped with a built-in navigation data memory. Depending on the country, the necessary navigation data may already be pre-installed.

To provide correct route guidance and make the most of the functions offered, the infotainment system should be updated on a regular basis.

Using obsolete data may lead to errors during navigation. Current routes cannot be traced or the route guidances will lead to mistaken destinations.

Ensure navigation data is updated at all times.

#### Online updating of navigation data

The navigation data of the regions through which you travel frequently is automatically updated in the background if the Internet connection is established and the privacy settings are valid.

- With the ignition switched on, the navigation data is updated automatically.

#### Manual update of navigation data

Current navigation data for large regions, for example Western Europe, can be downloaded from [www.seat.com](http://www.seat.com) and stored on USB data devices. Navigation through USB data devices is not possible.

- Download the navigation data to a USB data device.
- Turn on the ignition of the vehicle.
- Connect the USB data device to the infotainment system. Navigation data is automatically updated in the background.

The map version is displayed in **Settings > System information**.

#### WARNING

If you update the navigation data manually while driving, it may cause accidents with serious injuries.

- Update the navigation data only with the vehicle at a standstill.

#### Note

Automatic update of the navigation data is subject to the privacy settings. In "Incognito" mode, no update is carried out.

### Start route guidance





Depending on the country and equipment, different functions are available to enter destinations.

The different functions for entering destinations are found in the navigation main menu.

#### Opening the Navigation main menu

- Press  **Navigation**.

#### Select the destination and start navigation

1. Press .
2. Select the desired destination. You can choose from  **Frequent destinations**,  **Last destinations** and  **Favourite destinations**.

**OR:** press  and enter the address in the input screen.



**OR:** detailed address.

3. Press **Start**.

### Frequent destinations

The destination synopsis uses recorded data to propose possible destinations.

#### Select the destination and start navigation



1. Press  and then .
2. Select the desired destination. The route guidance starts automatically.

**Quick start:** for a quick start, press and hold the desired destination for a few seconds.

### Last destinations

Navigation saves the last destinations to make them available for a route guidance.

#### Select the destination and start navigation

1. Press  and then .
2. Press the desired destination.
3. Press **Start**.



**Quick start:** for a quick start, press and hold the desired destination for a few seconds.

### Favourite destinations

Save up to 20 destinations as favourites.

To save a destination as a favourite press  in the split screen when entering the destination.

#### Select the destination and start navigation

1. Press  and then .
2. Press the desired destination.
3. Press **Start**.

#### Note

Enter the destination as accurately as possible. If you enter a destination incorrectly, the route guidance will not be able to start or it will guide you to an incorrect destination.

#### Start route guidance by selecting from the map

The navigation map includes active areas at many points that are suitable for entering the destination. To do this, press the desired position or place on the map. If there is map data at this point, you can start a route guidance.

Whether it is possible to enter the destination through the navigation map depends on the state of the data and it is not possible for all positions.

To start “offroad navigation”, press an empty area without position data.

#### Start navigation

- Press .
- Move the view on the map until the desired position can be selected. The navigation map can be used by means of additional finger movements >>> page 182.
- Press the desired destination on the map.
- Press **Route**.

#### Offroad navigation

“Offroad navigation” calculates routes to selected destination points using unknown data. When a destination point is outside the known roads or position data, navigation finds the route to the next point of the known road and completes the path to the next destination point with a direct connection.

#### Start navigation

- Move the view on the map until the desired position can be selected. The navigation map can be used by means of additional finger movements >>> page 182.
- Press on any point on the map without position data.
- Press **Route**.

## Start route guidance using contact details

Start route guidance with the saved address data of a contact. Contacts saved without address data cannot be used for route guidance.

### Start navigation

- Press .
- Press on the contact you want.
- Press **Route**.

#### Note

**If the address details of a contact are obsolete, the route guidance will nevertheless take you to the registered address. Check that the contact address is updated.**

## Traffic information

The infotainment system receives detailed traffic information automatically if the Internet connection is established. This information is shown with symbols and highlighting the road network in colour on the map.

### Traffic incidents

Traffic incidents, for example, traffic jams or congested traffic, are shown on the navigation map using symbols.

With an active route guidance, traffic incidents that are on the current route are shown in the route details. Such traffic incidents can be avoided»» page 186 .

### Hazard information

Hazard information is shown on the navigation map with symbols in the same way as traffic incidents. In this case, the source of this information is another vehicle that has detected the hazard and has uploaded the information to the service provider.

The hazards shown are: accident, broken down vehicle and slippery road surface.

### Traffic flow indication

The navigation map shows traffic flow according to current traffic events, highlighting the road network in colour.

- **Orange:** Slow traffic.
- **Red:** Traffic jam.

#### Note

**Traffic information receipt is subject to the privacy settings. In maximum Privacy mode, no traffic information is received. Tracking or Location level setting is necessary.**



## Function descriptions

### Route details

The route details contain information on all incidents, for example, the starting point, stopovers, traffic events, POIs and destination, provided the navigation has such data.

If you press on an incident, an additional window opens providing more options. The available options depend on the incident and the current settings.

### Open and close the route details

- To open, press  or swipe it.
- To close, press  or swipe it.

### Edit route guidance

To edit route guidance, move the stopovers to the destination in the TripView view.

- Hold the desired destination pressed until it is visibly highlighted.
- Move the destination to the desired position.
- Remove your finger from the screen. The route will recalculate.

### Avoid traffic incidents

The details of the route show the current traffic incidents if the navigation has such

data. Avoid traffic incidents by editing route details»» page 186 .

- Press on a traffic event.
- Press on **Avoid**. The route will recalculate.

### Split screen

When handling navigation functions, an additional window with other options may open. Possible options depend on the function being used.

### Close the additional screen

- Press on an empty area outside the additional window.
- **OR**: press **X**.
- **OR**: press **Accept**.

### Functions in the additional window:

Show on map	Show what is selected on the map.
Add stopover	Add a stopover to the route guidance.
Direct route	Starts direct route guidance.
Delete	Delete a stopover from the route guidance.

### Functions in the additional window:

Avoid	Avoid traffic jam. The route will recalculate.
Stopping route guidance	Ends the current route guidance.
X	Close the additional window.
☆	Add a destination to favourites.

### Learn usage pattern

When the vehicle is in motion, navigation saves routes and destinations used to automatically generate destination proposals. Destinations are learned based on the time of day and the day of the week.

Navigation can propose up to 5 routes at the same time. The proposed routes may be different from the routes of the normal route guidance.

If one of the proposed destinations is selected, the guide to that destination is started.

The route guidance follows the selected route until the vehicle deviates from it. In that case, the route is recalculated and takes

you back along the most direct path to the initially selected destination.

Important traffic jams are taken into account in the route guidance, and are avoided if alternative routes are available, provided navigation has such data.

You can activate and deactivate the function whenever you want.

### Enable and disable learning usage pattern

The setting is in the corresponding navigation menu **⚙** > **Basic function settings**.

- To activate the function, activate **Learn usage pattern**.
- To disable the function, disable **Learn usage pattern**.
- To delete saved data, press **Delete usage pattern**.

## Telephone interface

### Introduction

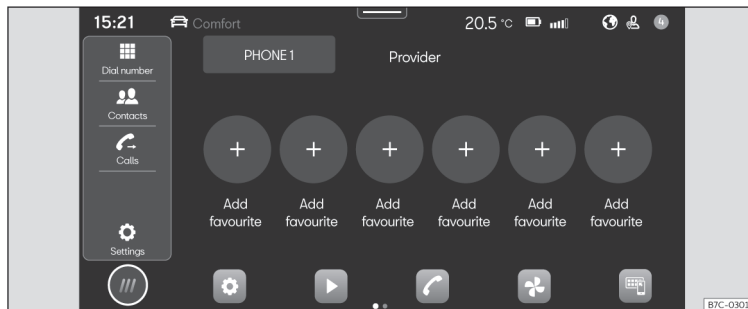

**Fig. 130** Schematic representation: Phone view

You can use the telephone interface to connect your mobile to the infotainment system and operate phone functions through it. The sound is played through the vehicle's speakers.

You can connect up to two mobile phone devices simultaneously to the infotainment system.

High speeds, poor weather or road conditions and a noisy ambience (even outside of the vehicle), as well as the quality of reception can all affect the quality of a telephone conversation in the vehicle.

#### Note

- As a general rule, pairing a device (for example, a mobile phone device) is only necessary once. You can restore the device connection via Bluetooth® or Wi-Fi with the infotainment system whenever you want without having to pair the device again.
- The availability of some telephone functions will depend on the mobile phone connected to the infotainment system.

## Telephone interface equipment and symbols

### Equipment features

- Hands-free function.
- Use up to two phones at the same time.
- Phone book with a maximum of 5,000 contacts.
- SMS functions via Bluetooth®: SMS reading, SMS writing (templates included), SMS playback, message history.
- Email functions via Bluetooth®: reading email, writing email.

- Connection to wireless charging option.
- Connection to the microphone mounted on the vehicle.

### Symbols in the main menu

- Contacts.
- List of incoming and outgoing calls.
- Enter telephone number.
- Text messages (SMS and emails).
- Telephone interface settings.

### Symbols for calls

The symbols may be different depending on the infotainment system.

- Start a call or bringing it to the foreground.
- End or reject a call.
- Open contact list.
- Enter telephone number.
- Mute the sound of the hands-free
- Hold call.
- Continue call.
- Start conference call.
- Pass call to private mode
- Make an emergency call.
- Get help in case of breakdown.

- Obtain information on the CUPRA brand and selected additional services related to traffic and your travel.

Voice mail.

### Call list symbols

- To open the call lists, press .
- Incoming call.
- Outgoing call.
- Missed call.
- Telephone number (company).
- Telephone number (private).
- Mobile telephone number (company).
- Mobile telephone number (private).
- Fax (private).
- Fax.

### Symbols for text messages

The symbols may be different depending on the infotainment system.

- To open the text messages, press .
- Activate voice control input  
»» page 172.
- Templates for text messages.

### Places with special regulations

Switch off the mobile telephone and the telephone interface in places with a risk of explosion. These places are not always clearly marked. They include, for example:

- The vicinity of chemical pipelines and tanks.
- The lower decks of boats and ferries.
- In the proximity of vehicles that run on liquefied gas (such as propane or butane).
- Places where the air is laden with chemicals or particles such as flour, dust or metal powder.
- All other places where the vehicle engine or telephone must be switched off.

### WARNING

Switch off the mobile phone in areas with a risk of explosion!

### Note

In areas where special regulations apply or the use of mobile phones is forbidden, it must be switched off at all times. The radiation produced by the mobile phone when switched on may interfere with sensitive technical and medical equipment, possibly resulting in malfunction or damage to the equipment.

## Pair, connect and manage

Requirement for pairing:

- Bluetooth® is activated on the mobile phone device.
- Bluetooth® is activated on the infotainment system.
- Depending on the mobile device, it will be necessary to have the Bluetooth® menu open or activate the **Visibility** option so that the device is visible from the infotainment system.

Pair a mobile phone device suitable for telephony with the infotainment system to use the telephone interface functions. On the first connection, the mobile phone device is paired with the infotainment system. Doing so saves a user profile»» page 190.

The pairing can take a few minutes. The functions available depend on the mobile phone device used and its operating system.

### Pair a mobile phone device

- Open the list of available Bluetooth® devices on the mobile phone device and select the name of the infotainment system.
- Please note and, if necessary, confirm the messages that appear on the mobile phone device and on the infotainment system. If the pairing was successful, the phone data is saved in the user profile.

- *Optional:* confirm the data transfer message on the mobile phone device.

### Active and passive connection

To use the functions of the telephone interface, there must be at least one mobile phone device *connected* to the infotainment system. If there are several mobile phone devices connected to the infotainment system, you can switch between active and passive connections. To use the telephone interface with the desired mobile phone device, establish the active connection with the infotainment system.

### Difference between connection types

Primary	The mobile phone device is paired and connected. The functions of the telephone interface are performed with the data of said mobile phone device.
Secondary	The mobile phone device is paired and connected. Calls can be managed but the phone book, messages or other functions will not be active.

Paired mobile phone devices are stored in the infotainment system, even if they are not currently connected.

### Connect a mobile phone device

*Requirement: the mobile phone device is paired with the infotainment system.*

- Bluetooth® is activated on the mobile phone device.

### Establish an active connection

*Requirement: several mobile phone devices are connected to the infotainment system at the same time.*

- Select the desired mobile phone device from the drop-down menu. All other mobile phone devices are automatically in the passive connection.

### User profiles

For each of the paired mobile phone devices an individual user profile is automatically created. In the user profile, data from the mobile phone device is stored, for example, contact details or settings. A maximum of four user profiles can be saved in the infotainment system at the same time.

### WARNING

**If you perform the pairing while driving, it could cause an accident or injury.**

- Perform pairing only with the vehicle at a standstill.



### Note

- In the pairing of some mobile phone devices, a PIN number is shown on the screen of the mobile phone device. Enter that number in the infotainment system to complete the pairing.
- While the infotainment system is in the **Known mobile phones menu**, the wireless charging function is disabled. When you exit this menu, the wireless charging function is activated again.

## Basic and Comfort Telephony

Depending on the equipment, two types of telephone interface can be used:

- Basic telephone interface.
- Comfort telephone interface.

### Basic telephone interface

The Basic telephone interface uses the Bluetooth® HFP profile for transmission. This interface allows the use of telephone functions through the infotainment system and playback through the vehicle's speakers.

### Comfort telephone interface

Like the Basic telephone interface, the Comfort telephone interface also uses the Bluetooth® HFP profile.

The Comfort phone interface can be equipped with the wireless charging function >>> page 192.

In order to use the functions of the wireless charging function, you have to place a suitable mobile phone device correctly in the storage compartment. The mobile phone device will then connect to the vehicle antenna. This improves the reception and sound quality of calls.

## To call

### Open the telephone interface



- Press  **Telephone**.

### Make a call

Select a phone number to start a call. Different functions are available for selecting a phone number:

### **Contacts**



If a contact has several registered phone numbers you have to select one.

- Press  and press a number on the list to start the call.
- **OR:** press  and enter the contact name in the input field to search for it. Press on the contact to start the call.

- **OR:** press a favourite in the telephone interface main menu to start the call.



### **Calls**

The telephone interface shows the call list of the mobile telephone device. Start a call from the call list.

- Press  > **All** and press a number on the list to start the call.
- **OR:** press  and filter the call list entries (for example, missed calls or dialled numbers). In filtered list, press a number to start the call.

### **Dial**

Manually enter a phone number to start a call. While entering the phone number, contacts that match that number are shown on the infotainment screen.

- Press  and enter telephone number.
- Press  to start the call

The last call is dialled by pressing and holding the  button on the multifunction steering wheel.

## Send messages

Depending on the mobile phone device and the infotainment system used, you can send »

and receive SMS and e-mails through the telephone interface.

### Send an SMS

- Press **✉ > Text message > Enter new message** and enter the message on the screen.
- Enter the contact you want in the search bar.
- To send the message press **OK**.

### Send an e-mail

- Press **✉ > E-mail > Enter new message** and enter the message on the screen.
- Enter the contact you want in the search bar.
- To send the message press **OK**.

## Phone book, favourites and speed dial buttons

In the first connection of a telephone with the infotainment system, the phone book is saved in the infotainment system. It may be necessary to confirm the data transmission on the mobile phone.

Each time the phone is reconnected, the phone book is updated.

If conference calls are supported, the phone book can be accessed during a call. If there is a saved image for a contact, it can be displayed in the list next to the entry.

### Favourites

A speed dial button can be assigned to a phone book favourite up to a maximum of six. If there is a registered photo saved to the contact, it is shown on the speed dial button.

All speed dial buttons have to be manually edited and will be assigned to a user profile.

### Assign the speed dial button

- In the **Favourites** menu, press the **+** button, then open the phone book to select a contact as a favourite. If the contact has several phone numbers, press on the number in the list.

### Edit the speed dial button

- To edit or delete a favourite contact press on the icon  in the **Favourites** menu screen. You can delete one or more favourites.

### Call a favourite

- Press the assigned speed dial button.

#### Note

**Favourites are not updated automatically. If you change a contact's phone number, you have to reassign the speed dial button.**

## Connectivity Box



**Fig. 131** In the centre console: pad for the mobile phone connection.

The Connectivity Box includes the *Wireless Charger* functionality.

## (Wireless Charger)

The Wireless Charger allows mobile devices with Qi<sup>1)</sup> technology to be charged without a cable.

To charge your mobile phone wirelessly:

- Place your mobile device in the middle of the pad with the screen facing up >>> **Fig. 131** >>> ⚠.

Make sure there are no objects between the pad and the mobile phone.

The mobile phone will start charging automatically. For further information about whether your mobile device supports Qi technology, check your phone's user manual or visit the CUPRA website.

### ⚠ WARNING

- The mobile phone may heat up due to the wireless charging. Think about this before you pick it up, and take care when removing it.
- There must be no metallic or other objects between the mobile phone and the housing, to prevent the functionality of the Connectivity Box from being affected.

### **i** Note

- Your mobile device must support the Qi inductive charging interface standard for proper operation.
- The charging time and the temperature vary in accordance with the device used.
- The maximum charging capacity is 5 W.
- Qi technology does not allow you to charge more than one mobile device simultaneously.
- You are advised to keep the engine running to guarantee proper wireless charging.
- When a telephone with Qi technology is connected by USB, it will be charged by the means specified by the manufacturer.

## Multimedia

### USB port



**Fig. 132** Centre console: USB port.



**Fig. 133** Rear part of the centre console: USB connectors with power outlet function. >>

<sup>1)</sup> Qi technology allows you to charge your mobile phone wirelessly.

The USB port can be found in the storage compartment area of the front centre console»» **Fig. 132.**

Depending on the equipment and the country, the vehicle may also have USB connections **exclusively for charging or as a power socket.**

These USB ports are located at the rear of the console, between the front seats  
»» **Fig. 133.**

## Driving

### Start and driving

#### Starting and stopping the engine

##### Ignition and start button

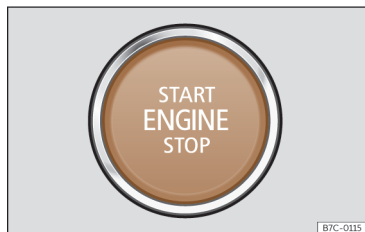

Fig. 134 Starter button

The engine can be started with a start button (Press & Drive). To do so, there must be a valid key inside the vehicle in the area of the front or rear seats, or on the centre console.

The **START ENGINE STOP** button is found at the bottom of the centre console or, depending on

the version, on the multi-function steering wheel.

In vehicles with the Keyless Access >>> page 90 system, the engine can also be started with the key in the luggage compartment.

Opening the driver's door **when exiting the vehicle** activates the electronic lock on the steering column if the ignition is disabled.

##### Switching the ignition on/off

If you only want to switch on the ignition (without starting the engine), briefly press the start button once **without pressing** the brake pedal or the clutch pedal >>> .

The **START ENGINE STOP** push-button text flashes like a heartbeat when the system is ready for the ignition to be turned on or off<sup>1)</sup>.

##### Automatic ignition disconnection

If the driver leaves the vehicle, taking the key with them but leaving the ignition on, the ignition does not switch off automatically. The ignition is switched off by pressing the lock button on the remote control  or by pressing the sensor surface on the door lever >>> Fig. 72.

##### Automatic deactivation of the ignition on vehicles with the Start-Stop system

The ignition is switched off automatically when the vehicle is stopped and the automatic engine shutdown is active, if:

- The driver's seat belt is not fastened,
- the driver does not step on any pedal,
- the driver door is opened.

After automatically turning off the ignition, if the dipped beam  is on, the side light remains on for approx. 30 minutes (if there is enough charge in the battery). If the driver locks the vehicle or manually turns off the light, the side light goes out.

##### Engine restart feature

If no key is detected inside the vehicle after the engine stops, you will only have 5 seconds to restart it. A warning will display on the dash panel screen.

After this interval, it will not be possible to start the engine without a valid key inside the vehicle.

##### "My Beat" function<sup>1)</sup>

For vehicles with a convenience key there is the "My Beat" function. This feature provides »

<sup>1)</sup> Valid for versions with the start button on the centre console.

an additional indication of the vehicle ignition system.

When entering the vehicle, the start button >>> **Fig. 134** flashes to draw attention to it.

When the ignition is on/off, the engine start button flashes. With the ignition is switched off, the start button goes off after a few seconds.

With the engine running, the start button light stays on, indicating that the engine is running. The time elapsed between the moment the user starts the engine with the start button and the lighting changes from flashing to fixed will depend on specific engine size characteristics. When the start button is used to stop the engine, the button starts flashing again.

In vehicles **with the Start-Stop system**, the “My Beat” function also offers additional information:

- When the engine stops during the Stop phase, the light of the start button stays on, as the Start-Stop system remains active even though the engine is off.
- When the engine cannot be started again with the Start-Stop system, >>> page 199 , and needs to be started manually, the start button flashes to indicate this situation.

#### WARNING

When switching on the ignition, *do not* press the brake or clutch pedal, otherwise the engine could start immediately.

#### WARNING

If vehicle keys are used negligently or without due care, this may cause accidents and serious injury.

- Never leave any key inside the vehicle when you leave it. Otherwise, a child or unauthorised person could lock the vehicle, start the engine or connect the ignition and operate any of the electrical equipment.

#### Note

- Before leaving the vehicle, always disconnect the ignition and, if appropriate, take into account the instructions on the screen of the dash panel.
- If the vehicle is stationary for a long time with the engine off and the ignition on, the vehicle battery might be discharged and it might not be possible to start the engine.
- If during the STOP phase you press the **START ENGINE STOP** button, the ignition is switched off and the push-button flashes<sup>1)</sup>.

- If the indication is displayed on the instrument panel display “Start-Stop system deactivated: Start the engine manually”; the **START ENGINE STOP** button will flash<sup>1)</sup>.

## Starting the engine

- Vehicles with automatic transmission: put the selector lever in **P** or **N**, press the brake pedal and keep it pressed in this position until the engine starts.
- Press the starter button >>> **Fig. 134**; do not press the accelerator. There needs to be a valid key inside the vehicle for the engine to start. After starting the engine, the lighting of the **START ENGINE STOP** button remains fixed indicating that the engine is running<sup>1)</sup>.
- Once the engine starts, release the start-up button.
- If the engine does not start, stop and wait for around 1 minute to try again. If necessary, perform an emergency start >>> page 198 .

#### WARNING

Do not keep the engine running in confined spaces, as there is a risk of poisoning.

- The exhaust gases contain carbon monoxide, an odourless and colourless

<sup>1)</sup> Valid for versions with the start button on the centre console.

poisonous gas that can cause loss of consciousness and death.

### WARNING

Do not get out of the vehicle with the engine running, especially if a gear is engaged. The vehicle could then suddenly move or something strange could happen that would cause damage, fire or serious injury.

### WARNING

Never use cold start sprays, they could explode or cause the engine to run at high revs. Doing this risks injury.

### CAUTION

- The starter motor or the engine may be damaged if you try to restart the engine immediately after switching it off.
- When the engine is cold, you should avoid high engine speeds, driving at full throttle and over-loading the engine, as this could cause engine damage.

### For the sake of the environment

Do not warm-up the engine by running the engine with the vehicle stationary. Start off immediately, driving gently. This helps the engine reach operating temperature faster and reduces emissions.

### Note

- Electrical components with a high power consumption are switched off temporarily when the engine starts.
- When starting with a cold engine, noise levels may briefly increase. This is quite normal, and no cause for concern.

## Turning off the engine

- Bring the vehicle to a full stop >>> .
- Move the selector lever to the **P** position.
- Apply the electronic parking brake.
- Briefly press the start-up button >>> **Fig. 134**.

### Emergency disconnection

If the engine does not switch off after briefly pressing the starter button, an emergency disconnect will be required:

- Press the starter button twice within 3 seconds or press it once for more than 1 second >>>  in Ignition and start button on page 196.

### WARNING

Never switch off the engine while the vehicle is moving. This could cause loss of control of the vehicle, accidents and serious injury.

- The airbags and belt tensioners do not work when the ignition is switched off.
- The brake servo does not work with the engine off. Therefore, you need to press the brake pedal harder to brake the vehicle.
- Power steering does not work when the engine is not running. You need more strength to steer when the engine is switched off.
- If the ignition is switched off, the steering column could be locked, making it impossible to control the vehicle.

### WARNING

Always take the key with you when you leave the vehicle. This is particularly important if there are children in the vehicle, as they might otherwise be able to start the engine or use power-operated equipment (e.g. the electric windows), which could cause injuries.

### CAUTION

- If the vehicle is stopped and the Start-Stop system switches off the engine, the ignition remains switched on. Make sure that the ignition is switched off before leaving the vehicle, otherwise the battery could discharge.
- If the engine has been driven at high speed for a prolonged period of time, it may overheat when switched off. To avoid

damage, allow the engine to run for approximately two minutes in neutral before switching it off.

#### Note

After the engine is switched off the radiator fan may run on for up to 10 minutes, even if the ignition is switched off. It is also possible that the fan turns itself on once more if the coolant temperature increases due to the heat accumulated in the engine compartment or due to its prolonged exposure to solar radiation.

## Electronic immobilizer

The electronic immobiliser prevents unauthorised persons from driving the vehicle.

In the key there is a chip that automatically deactivates the electronic immobiliser.

The electronic immobiliser is automatically activated when the key is outside the vehicle.

If the following message is shown on the instrument panel display: **SAFE**, the vehicle cannot be started.

The engine can only be started using a genuine CUPRA key with its correct code.

#### Note

A perfect operation of the vehicle is ensured if genuine CUPRA keys are used.

## Emergency starting function



**Fig. 135** On the right of the steering column» Fig. 135, as close as possible to the Kessy logo.

If no valid key is detected inside the vehicle, an emergency start-up will be required. The relevant message will appear in the dash panel display. This may happen when, for example, the vehicle key battery is very low:

- Immediately after pushing the starter button, keep the key next to the right trim of the steering column» **Fig. 135**, as close as possible to the Kessy logo.
- The ignition connects and the engine starts automatically.

## Instructions for the driver on the instrument panel display

### Press the brake

- This message appears on vehicles with an automatic gearbox if the driver tries to start the engine without having the brake pedal pressed.

### Select N or P

- This message appears if you try to start or stop the engine when the selector lever of the automatic gearbox is not in position **P** or **N**. The engine can only be started and stopped in those positions.

### Engage position P; the vehicle can move; doors can only close in position P.

- For safety reasons, this driver message appears and an audible warning sounds if the selector lever of the automatic gearbox is not in position **P** after you switch off the ignition. Move the selector lever to the **P** position, otherwise the vehicle could move.

### Gear change: selector lever in the drive position!

- This driver message is displayed when the selector lever is not in the position **P** when the driver door is opened. Additionally, a buzzing sound is emitted. Put the selector



lever in position **P**, otherwise the vehicle could roll away.

### Ignition is switched on

- This driver message is displayed and a buzzer is sounded when the driver door is opened with the ignition switched on.

## Start-Stop system

### Control lamps

#### It lights up

The Start-Stop system is available, the automatic engine shutdown is active.

#### It lights up

The Start-Stop system is not available or has been disconnected.

### Instructions for the driver on the instrument panel display

#### Start-Stop system deactivated. Start the engine manually

- This indication for the driver shows that the Start-Stop system **cannot** start the engine again.

#### Start-Stop system: Fault! Function not available

- There is a fault in the Start-Stop system. Take the vehicle to a workshop to have the fault repaired.

### Description and operation

The Start-Stop system helps you to save fuel and reduce CO<sub>2</sub> emissions.

In Start-Stop mode, the engine will automatically switch off when the vehicle stops or is stopping. The ignition remains switched on. The engine automatically switches back on when required.

In this scenario, the light of the **START ENGINE STOP** button stays lit<sup>1)</sup>.

When the ignition is switched on, the Start-Stop function is automatically activated.

### Stopping and starting the engine

- Brake until the vehicle has come to a standstill, and keep your foot on the brake pedal or activate the Auto Hold system so that the vehicle remains braked. The engine will stop. The warning lamp  will appear in the display. The engine can be stopped before stopping completely (approximately 7 or 2 km/h depending on the vehicle's gearbox).
- When you take your foot off the brake pedal the engine will start up again. The warning lamp will switch off. With the Auto Hold system, the engine will not start if you remove your foot from the brake pedal. The car starts when you press the accelerator pedal.

### Basic requirements for the Start-Stop mode

- The driver door must be closed.
- The driver's seat belt must be fastened.
- The bonnet must be closed.
- The engine has reached operating temperature.
- The reverse gear must not be engaged.
- The vehicle must not be on a very steep slope. »

<sup>1)</sup> Valid for versions with the start button on the centre console.

### The engine does not turn off for various reasons

Before stopping the vehicle, the system verifies whether certain conditions are met. The engine **does not** switch off, in the following situations for example:

- The engine has not yet reached the required temperature for the Start-Stop mode.
- The temperature selected on the climate control has not been reached.
- The interior temperature is very high/low.
- Defrost function button activated >>> page 142.
- Park assist is switched on.
- The battery is very low.
- The steering wheel is overly turned or is being turned.
- If there is a danger of misting.
- After engaging reverse gear.
- In case of a very steep gradient.

 is displayed on the instrument cluster screen; it is also displayed in the driver information system, START  STOP.

### The engine starts by itself

When stopped, the normal system mode may be interrupted in the following situations. The engine restarts by itself without involvement from the driver.

- The interior temperature differs from the temperature selected on the climate control.
- Defrost function button activated >>> page 142.
- The brake has been pressed several times consecutively.
- The battery is too low.
- High power consumption.

### Additional information related to the automatic gearbox

The engine stops when the selector lever is in the positions **P**, **D**, **N** and **S** in addition to when in Tiptronic mode. With the selector lever in **P**, the engine will also remain switched off when you take your foot off the brake pedal. In order to start the engine up again the accelerator must be pressed, or another gear engaged or the brake released.

If the selector lever is placed in **R** while stopped, the engine will start up again.

Change from **D** to **P** to prevent the engine from accidentally starting when passing through **R**.

### Additional information about vehicles with Adaptive Cruise Control (ACC)

In vehicles with ACC function, the engine will start up again in certain operating conditions if the radar sensor detects that the vehicle ahead drives off again.

### WARNING

- Never switch the engine off until the vehicle is stationary. The operation of the brake and steering will not be fully guaranteed. More force will be needed to turn the steering wheel or to brake. You could suffer an accident and even serious injuries.
- To avoid injury, make sure that the Start-Stop system is switched off when working in the engine compartment >>> page 201.

### CAUTION

The Start-Stop system must always be switched off when driving through flooded areas >>> page 215.

### Note

- You can control whether the engine should switch off or not by reducing or increasing the brake force applied. While the vehicle remains stopped, the engine will not stop if the brake pedal is slightly pressed, in traffic jams with frequent stopping and starting for example. As soon as strong pressure is applied to the brake pedal, the engine will stop.
- When stopped, the brake pedal must be kept pressed to ensure that the vehicle does not move.
- If the lever is placed in position **D**, **N** or **S** after engaging reverse gear, 10 km/h (6 mph) in a forwards direction must be

reached for the system to be in a condition to stop the engine.

## Manually connecting and disconnecting the Start-Stop system



**Fig. 136** Centre console: Start-stop system button.

If you do not wish to use the system, you can switch it off manually.

- To manually switch on/off the Start-Stop system, press the button»» **Fig. 136**.

The button symbol remains lit up yellow when the system is switched off.

### Note

**The system switches on every time the engine is turned off voluntarily.**

## DSG automatic transmission

### Introduction

Your vehicle is equipped with an electronically controlled manual gearbox. Torque between the engine and the gearbox is transmitted via two independent clutches. They replace the torque converter found on conventional automatic gearboxes and allow for smooth, uninterrupted acceleration of the vehicle.

The **Tiptronic** system allows the driver to change gears *manually*»» page 203, Changing gear in Tiptronic mode.

### Control lamps

#### It lights up green

The brake is not pressed.  
To select a gear range, press the brake pedal.

#### Flashes green

The selector lever locking button is not engaged.  
The vehicle is prevented from moving forwards. Engage the selector lever lock.

### Selector lever positions

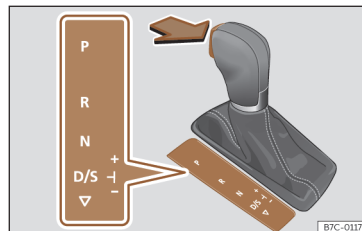

**Fig. 137** Selector lever lock.

The selector lever position is shown when the corresponding sign lights up. With the selector lever in the manual gearbox positions **M**, **D** and **S**, the engaged gear is also shown on the display.

### **P** – Parking lock

When the lever is put in this position, the drive wheels are locked. The lever must only be put in **P** when the vehicle is *stationary* »» .

To put the lever in **P** or take it out of **P**, the locking button must be pressed and held and the brake pedal pressed simultaneously. »»

**R – Reverse gear**

Reverse gear must be engaged only when the vehicle is *stationary* and the engine is idling >>> .

To move the lever to position **R**, the lock button must be pressed and held while pressing the brake pedal at the same time. The reverse lights come on when the lever is in the **R** position with the ignition on.

**N – Neutral**

With the lever in this position, the gear is in neutral.

Press the brake pedal to move the lever from **N** to **D/S** when the vehicle is stationary or at speeds below 3 km/h (2 mph) >>> .

**D/S – Permanent forward drive position**

The lever in the **D/S** position enables the gears to be operated in normal mode (**D**) or sport mode (**S**). To select Sport mode **S**, move the lever backwards. Pushing the lever again will select normal mode **D**. The selected driving mode is shown on the instrument panel display.

In **normal mode (D)**, the gearbox selects the best gear ratio. This depends on the engine load, the road speed and the dynamic gear control programme (DCP).

**Sport mode (S)** should be selected for a sporty driving style. This setting makes use of

the engine's maximum power output. When accelerating the gear shifts will be noticeable.

Under certain circumstances (e.g. on mountain roads) it can be advantageous to switch tiptronic mode >>> page 203, to adapt the gears to suit the road conditions.

**Selector lever lock**

In **P** or **N**, the lever lock prevents a gear range from being engaged, and prevents the vehicle from moving off accidentally.

To release the gear lever lock, press and hold the brake pedal with the ignition on. At the same time, press the lever lock in the direction of the arrow >>> **Fig. 137**.

As a reminder to the driver, when the lever is in positions **P** or **N** the following indication will be shown on the screen:

**When stationary, apply footbrake while selecting a gear.**

The lever is not locked if it is moved quickly through position **N** (e.g. when shifting from **R** to **D**). This makes it possible, for instance, to “rock the vehicle backwards and forwards” if it is stuck in snow or mud. The lever lock engages automatically if the brake pedal is not pressed and the lever is in position **N** for more than about one second at a speed of less than 5 km/h (3 mph).

 **WARNING**

- Take care not to press the accelerator pedal when the vehicle is stopped. The vehicle could start moving immediately (in some cases even if the parking brake is engaged) resulting in the risk of an accident.
- Never move the lever to **R** or **P** when driving. Failure to follow this instruction could result in an accident or failure.
- With lever in any position (except **P**), the foot brake must be pushed down whenever the engine is running. This is because an automatic gearbox still transmits power even at idling speed.
- While you are selecting a gear and the vehicle is stopped with the engine running, do not accelerate. Failure to follow this instruction could result in an accident.
- As a driver you should never leave your vehicle if the engine is running and a gear is engaged. Switch on the electronic parking brake and select the parking lock (**P**).

 **Note**

- If the lever is moved accidentally to **N** when driving, release the accelerator and let the engine speed drop to idling before selecting gear range **D** or **S** again.
- Should the power supply to the lever be interrupted in position **P**, it will not be possible to move the lever. If this should happen the manual release can be used >>> page 207.

**Note**

- If the selector lever lock does not engage, there is a fault. The transmission is interrupted to prevent the vehicle from accidentally moving. To lock the selector lever again, press the brake pedal, place the selector lever in the P or N position and then engage a gear.
- If a gear has been selected, the vehicle does not move forwards or back. Proceed to the next mode:
  - When the vehicle does not move in the required direction, the system may not have the gear range correctly engaged. Press the brake pedal and engage the gear range again.
  - If the vehicle still does not move in the required direction, there is a system malfunction. Seek specialist assistance and have the system checked.

### Changing gear in Tiptronic mode

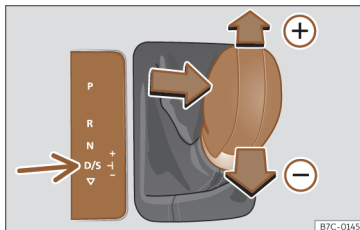

**Fig. 138** Centre console: tiptronic transmission



**Fig. 139** Steering wheel: automatic transmission levers



Tiptronic gives the driver the option to change gears manually.

When you change to the Tiptronic programme, the vehicle remains in the currently selected gear. This is possible as long as the

system is not changing gear automatically due to a traffic situation.



#### Using Tiptronic with the selector lever

It is possible to change to Tiptronic mode, both when the vehicle is stopped and while driving.

- Starting from the **D/S** position, move the lever to the right. The instrument panel will show whether the lever is in manual or Tiptronic mode (e.g. **M4**).
- Push the lever forwards  or backwards  to move up or down a gear >>> **Fig. 138**.
- To exit Tiptronic mode, move the lever to the left.

#### Using Tiptronic with the steering wheel paddles

The gearshift paddles can be used when the selector lever is in the **D/S** or **M** (Tiptronic) positions.

- Press the gearshift paddle  to select a higher gear >>> **Fig. 139**.
- Press the gearshift paddle  to select a lower gear.
- To exit the Tiptronic mode, pull the right-hand lever towards the steering wheel for approximately 1 second or move the lever to the left.

»

If the paddles are not operated for some time and the lever is not in the Tiptronic selection position, it will automatically exit from Tiptronic mode.

#### ⓘ CAUTION

- When accelerating, if a higher gear is not selected, it will automatically change shortly before reaching the maximum permitted RPM.
- Also, if a lower gear is selected, the system will not change until it detects that the engine will not reach its maximum RPM.

### Driving with an automatic gear-box

The gearbox changes gear ratios automatically as the vehicle moves.

The engine can only start with the selector lever in position **P** or **N**. At low temperatures, below -10 °C (+14 °F), the engine can only start with the selector lever in position **P**.

#### Driving down hills

Under certain circumstances it may be advantageous to use the Tiptronic mode to select the gear manually according to driving conditions >>> ⚠.

#### Stop/Park

On level ground, just use the lever to engage position **P**. On slopes you should first apply the parking brake and then set the lever to **P**. This makes it easier to remove the lever from position **P** when starting.

If the driver door is opened and the lever is not in position **P**, the vehicle could move. The following warning is displayed on the instrument panel: ⚠ **Gear change: selector lever in the drive position!**. Additionally, a buzzer will sound.

#### Stopping on a downhill

Always apply the brake pedal firmly to prevent the vehicle from moving; if necessary, apply the electronic parking brake >>> ⚠.

**Do not** accelerate while a range of gears is engaged to prevent the car from rolling downhill >>> ⓘ.

#### Starting off uphill with the Auto Hold function

- Once you have engaged a gear, take your foot off the brake pedal and gently press the accelerator.

#### Starting off uphill without the Auto Hold function

- Pull on the electronic parking brake button.

- Once you have engaged a gear, gently press the accelerator and pull on the electronic parking brake button.

#### Back-up programme

If all the positions of the lever are shown over a light background on the instrument panel display, there is a system fault and the automatic gearbox will operate in with the back-up programme. It is still possible to drive the vehicle, however, at low speeds and within a selected range of gears. **Driving in reverse gear may not be possible.**

#### Kick-down

The kick-down system provides maximum acceleration when the gear selector lever is in the positions **D**, **S** or in the Tiptronic mode.

When the accelerator pedal is pressed right down, the automatic gearbox will shift down to a lower gear, depending on road speed and engine speed. This takes advantage of the maximum acceleration of the vehicle >>> ⚠.

The upshift to the next higher gear is delayed until the engine reaches maximum rpm.

#### ⚠ WARNING

Observe the safety warnings >>> ⚠ in Selector lever positions on page 202.

- Never allow the brake to rub and do not use the brake pedal too often or for long periods, as the brakes can overheat. This reduces the braking power, increases the braking distance or even causes a brake system fault.
- If you have to stop on a hill, keep the vehicle's brakes applied with the brake pedal or parking brake.

### WARNING

Please note that if the road surface is slippery or wet, the kick-down feature could cause the driving wheels to spin, which could result in skidding.

### CAUTION

- If you stop the vehicle on a gradient, do not attempt to stop it from rolling by depressing the accelerator when a gear has been selected. This could cause overheating and damage the automatic gearbox.
- If you allow the vehicle to roll with the lever in position N and the engine off, the automatic gearbox will be damaged by lack of lubrication.

- In certain driving situations or traffic conditions, the gears could overheat and be damaged! If the warning lamp  lights up, stop the vehicle as soon as you can and wait for the gearbox to cool»» page 207 .
- If the gearbox operates with the backup programme, take the vehicle to a specialised workshop and have the fault repaired without delay.

### Launch-control program

The Launch-control programme enables maximum acceleration from a standstill.

*Condition:* the engine must have reached operating temperature and the steering wheel must not be turned.

The engine speed for Launch-control is different on petrol and diesel engines.

To use the Launch-control you must disconnect the anti-slip regulation (ASR) through the infotainment system menu»» page 82 . The warning lamp  will stay switched on or will flash slowly depending on whether or not the vehicle has a driver information system.

On vehicles with the driver information system, the ESC lamp lights up permanently and the corresponding text message **Stability control deactivated** (temporary) appears on the instrument panel to indicate the deactivation status.

- With the engine running, switch off traction control (ASR)»» page 251<sup>1)</sup>.
- Press the brake pedal with your left foot and hold it down for at least one second.
- Set the selector lever to position S or Tiptronic, or select the **Sport** or **Cupra Drive Profile**»» page 210 .
- With your right foot, press the accelerator down to the full throttle or kick-down position. The engine speed will stabilise at about 3,200 rpm (petrol engine) or about 2,000 rpm (diesel engine).
- Take your left foot off the brake pedal. The vehicle starts with maximum acceleration.

### WARNING

- Always adapt your driving style to the traffic conditions.
- Only use the Launch control programme when road and traffic conditions permit, »

<sup>1)</sup> Vehicles without a driver information system: the warning lamp flashes slowly. Vehicles with a driver information system: the warning lamp remains on.

and make sure your manner of driving and accelerating the vehicle does not inconvenience or endanger other road users.

- Make sure that the ESC remains switched on. Please note that when the ASR and ESC are deactivated, the wheels may start to spin, causing the vehicle to lose grip. Risk of accident!
- After moving off, the ESC “sport” mode should be deactivated by briefly pressing the  OFF button.

#### Note

- After using the Launch control programme, the temperature in the gearbox may have increased considerably. In this case, the programme could be disabled for several minutes. The programme can be used again after the cooling phase.
- Accelerating with the launch control programme places a heavy load on all parts of the vehicle. This can result in increased wear and tear.

### downhill assistant

Downhill speed control is activated when the lever is in the **D/S** position and the brake is applied. An appropriate lower gear is engaged.

The assistant attempts to maintain the speed at which the vehicle was travelling when the brake was applied, within logical limits. It may be necessary to correct the speed by pressing the brake.

The assistant can only change down as far as 3rd gear. It is possible that on very steep slopes you may have to switch to tiptronic mode and thus manually change down to 2nd or 1st gear to take advantage of engine braking and take the load off the brake system.

Downhill speed control is deactivated as soon as the road levels out again or you press the accelerator pedal.

On vehicles with a cruise control system >>> page 220, downhill speed control is activated when you set a cruising speed.

#### WARNING

The downhill speed control cannot defy the laws of physics. Therefore, speed cannot be maintained constant in all situations. Always be prepared to use the brakes!

### Inertia mode

The inertia mode allows you to travel certain distances without using the accelerator, which saves fuel. Plan ahead and use the inertia mode to “let” the vehicle “roll”.

### Activation of the inertia mode

*Status:* lever in position **D**, Drive Profile engine mode setting in **ECO**, gradients of less than 12% and speeds between 20 and 130 km/h (12 and 80 mph).

- Gently take your foot off the accelerator.

The indication will be shown on the instrument panel , the engaged gear and current consumption will disappear and the word **Inertia** will appear.

The gears will automatically disengage and the vehicle will roll freely, without the effect of the engine brake. While the vehicle rolls, the engine runs at idling speed.

### Stopping inertia mode

- Press the brake or the accelerator pedal.

To take advantage of the engine's inertia mode, simply remove your foot from the accelerator.

Applying both the **inertia mode** (= prolonged section with less energy) and **inertia disconnection** (= shorter section without the need for fuel) facilitates improved fuel consumption and emission balance.

With **Drive Profile** >>> page 210, the inertia mode can be activated in the **Comfort** or **Individual** profiles. If the engine is set to **ECO** in the **Individual** mode, it is activated when the operating conditions are met.



### **⚠ WARNING**

- If the inertia mode has been switched on, take into account, when approaching an obstacle, that the vehicle will not decelerate in the usual manner: risk of accident!
- When using inertia mode while travelling down hills, the vehicle can increase speed: risk of accident!
- If other users drive your vehicle, warn them about inertia mode.

### **i Note**

- The driver message *Inertia* is only displayed with the current consumption. In inertia mode the gear will no longer be displayed (for example “D” or “E” will appear instead of “D7” or “E7”).
- The inertia mode will be automatically disconnected on gradients steeper than 15%.

## Indications on the instrument panel display

### Clutch

- **⚠ Clutch overheating! Please stop!**
- The clutch has overheated and could be damaged. Stop and wait for the gearbox to cool with the engine at idling speed and the selector lever in position **P**. When the warn-

ing lamp and the driver message switch off, have the fault corrected by a specialised workshop without delay. If they do not turn off, do not continue driving. Seek specialist assistance.

### Faults in the gearbox

- **⚠ Gearbox: Fault! Stop the vehicle and place the lever in the position P.**
- There is a fault in the gearbox. Stop the vehicle in a safe place and do not continue driving. Seek specialist assistance.
- **⚠ Gearbox: System fault! You may continue driving.**
- Have the fault corrected by a specialised workshop without delay.
- **⚠ Gearbox: System fault! You can continue driving with restrictions. Reverse gear disabled**
- Take the vehicle to a specialised workshop and have the fault repaired.

- **⚠ Gearbox: System fault! You can continue driving in D until switching off the engine**
- Park the vehicle in a safe place. Seek specialist assistance.

### ⚠ Gearbox: too hot. Adapt your driving accordingly

- Continue driving at moderate speeds. When the warning lamp switches off, you can continue driving in a normal manner.

### ⚠ Gearbox: press the brake and engage a gear again.

- If the warning was caused by the temperature of the gearbox, this driver message will be displayed when the gearbox has cooled again.

## Manual release of the selector lever

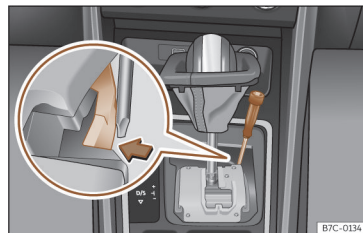



**Fig. 140** Gear selector lever: manual release from the parking position.

In the event of a power failure when starting (e.g. discharged battery), the lever will remain locked in position **P**. To move it to »

position **N** to move the vehicle, there is an emergency release device under the centre console, on the right side. Releasing the selector lever requires a certain degree of practical skill.

### Removing the cover from the selector lever

- Apply the electronic parking brake   .
- Carefully pull the corners of the selector lever boot and twist it upwards over the lever handle.

### Releasing the selector lever

- Using the flat part of a screwdriver, press the yellow tab sideways and keep it pressed down  **Fig. 14.0**.
- Press the lock button on the selector lever and move it to position **N**.
- After completing the emergency release, reattach the selector lever boot to the gear-box console.

#### WARNING

Do not move the lever from position **P** if the parking brake is not firmly engaged. If you still think the car could move, press the brake pedal. Danger! The vehicle could move in an unforeseen way and cause an accident or serious injury.

## Gear-change recommendation

### Selecting the optimal gear

Depending on the equipment on the instrument panel screen, a recommendation is shown with the gear that should be engaged to optimise consumption.

The lever must be in Tiptronic mode  page 203.

No recommendation will appear if the optimal gear is engaged. The current gear will be displayed.

Display	Meaning
<b>3</b>	Optimum gear.
<b>4 ▶ 5</b>	Changing to a higher gear is recommended.
<b>2 ▶ 1</b>	Changing to a lower gear is recommended.

### Information regarding the “cleanliness” of the particulate filter

When the exhaust system detects that the particulate filter is close to saturation, this system’s self-cleaning function recommends the optimal gear for that function  page 288.

#### WARNING

The gear change recommendation is an auxiliary function and in no case should be a substitute for careful driving.

- Responsibility for selecting the correct gear, depending on the circumstances, rests solely with the driver.

#### For the sake of the environment

Selecting the correct gear can help to save fuel.

#### Note

The recommended gear display turns off when you are no longer in tiptronic mode.

## Hill Descent Control (HDC)

### Control lamps



It lights up white

Hill Descent Control is active.



It lights up grey

Hill Descent Control is not active. The system is switched on, but is not adjusting.

Some control and warning lamps will light up briefly when the ignition is switched on to

check certain functions. They will switch off after a few seconds.

#### WARNING

Observe the safety warnings >>>  in Control and warning lamps on page 81.

### Description and operation

Hill Descent Control limits the speed on steep descents by automatically braking all four wheels, both when moving forward and in reverse. As the anti-lock brake system remains active, it prevents the wheels from locking.

After starting the descent of a slope below 30 km/h (18 mph), speed is limited to a minimum of 2 km/h (1 mph) and a maximum of 30 km/h (18 mph). When appropriate, the driver may increase or decrease the speed within the limit by pressing the accelerator or the brake. At this point the function is interrupted and, if necessary, it is then reactivated.

Even so, it is imperative that the surface guarantees sufficient adhesion. For this reason, the Hill Descent Control **will not** fulfil its function when, for example, descending a slope with a frozen or slippery surface.

Hill Descent Control is available when the dash panel display shows the message .

Hill Descent Control automatically intervenes if the following conditions are met:

- The vehicle engine is running.
- The **Offroad** driving profile has been selected >>> page 210 . Driving at a speed below 30 km/h (18 mph) (the message  is shown on the instrument panel).
- The slope of the descent is at least 10% when driving forward and 9% when driving in reverse.
- The brake and the accelerator are not pressed.

Hill Descent Control is deactivated on pressing the brake and the accelerator or if the slope is below 5%. The function can be switched off manually in the infotainment system using the  > **HDC** function button.

#### WARNING

Always be ready to brake. Otherwise, an accident could occur and cause injury.

- Hill Descent Control is only an auxiliary system that in some situations may not sufficiently brake the vehicle when going down a slope.
- The speed of the vehicle may increase despite the intervention of Hill Descent Control.

## Steering

### Information relating to different vehicle processes.

Electro-mechanical power steering adapts *electronically* to the speed of the car, torque and steering angle.

Even if the power steering fails or the engine is stopped, it is possible to continue to rotate the steering wheel as long as the key remains in the ignition, but more force must be applied.

#### Progressive steering

Depending on the vehicle's features, it may or may not incorporate a progressive steering system.

In *city traffic* you do not need to turn so much on parking, manoeuvring or in very tight turns.

On the *road* or on the *motorway*, progressive steering transmits, for example, in bends, a sportier, more direct and noticeably more dynamic driving sensation.

#### Steering assist

This help assists the driver in critical situations. It recommends turning the steering wheel to perform a corrective manoeuvre »

(counter-steering), turning slightly to avoid skidding >>> .

### WARNING

**Steering assist helps the driver in critical situations. The driver is the person who has to control the vehicle's steering at all times.**

## Control lamp

### It lights up red

Faulty steering.

**Do not continue driving**, stop the vehicle as soon as possible and in a safe manner.

Take the vehicle to a specialised workshop and have the fault repaired as soon as possible.

### It lights up yellow

Limited steering operation.

Drive carefully to a specialised workshop to have the steering checked.

If the warning light does not come on again after re-starting the engine and driving a short distance, it is **not** necessary to check the steering.

**OR:** The 12-volt battery was disconnected and reconnected.

Drive a short distance at 15-20 km / h (9-12 mph).

### It flashes yellow

The steering column is jammed.  
When stopped, turn the steering wheel in both directions.

**OR:** The steering column does not unlock or lock. Turn off the ignition and turn it on again. Consider the messages shown on the instrument panel display. **Do not continue driving** if the steering column remains locked after switching on the ignition. Seek specialist assistance.

The control lamp should light up for a few seconds when the ignition is switched on. It should go out once the engine is started.

### WARNING

**Never ignore the warning lamps or messages.**

- **If the warning lamps and the corresponding messages are ignored, the vehicle may stall in traffic, causing serious damage or accidents and injuries.**
- **Stop the vehicle at the next opportunity and in a safe place.**

## Driving modes (Drive Profile)

### Introduction

The Drive Profile enables the driver to choose between six profiles or modes, **Comfort, Sport, Cupra, Individual, Offroad and Snow**, that modify the behaviour of various vehicle functions, providing different driving experiences.

The **Individual** profile can be configured according to personal preferences.

### Description

Depending on the equipment fitted in the vehicle, the Drive Profile can operate on the following functions:

#### Engine

Depending on the profile selected, the engine responds more quickly or smoothly to the accelerator being pressed.

The gear change points are modified to position them in lower or higher engine speed ranges.

In addition, the function for taking advantage of inertia is activated in the **Individual** profile, when the engine is set to **ECO**, allowing consumption to be reduced further.

### Adaptive chassis control (DCC)

DCC continuously adapts the shock absorbers to the condition of the road and current driving conditions, according to the pre-set programme.

In the event of a fault in the DCC, the following message is displayed on the instrument screen **Fault: shock absorber regulation**

### Steering

The power steering varies its driving modes and adapts to the profile selected, thus offering the best behaviour for each situation.

### Air conditioning

Climatronic can operate in **Eco** mode, especially restricting fuel consumption.

### Adaptive Cruise Control (ACC)

Depending on the driving profile, the performance of the ACC varies, to allow more sporty acceleration and braking or a more respectful fuel consumption.

### Electronic Stability Control (ESC)

In the **Offroad** and **Snow** driving profiles, the electronic stability Control (ESC)»» page 250 adjusts to adapt to the terrain.

### Hill descent control assistant

This assistant can be activated or deactivated in the **Offroad** profile. Hill Descent Control limits the speed on steep descents by automatically braking all four wheels, both when moving forward and in reverse »» page 208.

### Hill Start Assist

It is possible to activate or deactivate this assistant in the **Offroad**.

### Parking assistants

The **Offroad** profile allows you to disable the parking assistant to avoid warnings during off-road driving.

## Setting the driving profile

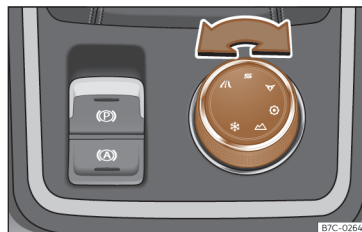

**Fig. 141** Centre console: Driving Experience button.



**Fig. 142** Multifunction steering wheel: button to change the driving profile.

You can choose from the **Comfort**, **Sport**, **Cupra**, **Individual**, **Offroad** and **Snow** profiles. »



The desired mode can be selected as follows:





- Turn the Driving Experience button to select the desired driving profile >>> **Fig. 141**.
- **OR:** briefly press the CUPRA button on the left hand side of the steering wheel >>> **Fig. 142** to change the driving profile. Press and hold the CUPRA button to access the **Cupra** profile directly. Press and hold again to return to the previous profile.

The features of each profile can be seen by pressing the **Profile information** function button.

In the **Individual** profile it is possible to configure the characteristics of the vehicle using the **Profile setup** function button.

An icon on the infotainment system display informs about the active profile. The selector identifies the profile chosen by means of a red LED light.

Driving profile	Characteristics
 Comfort	It permits more relaxed and comfortable driving, for example for long motorway journeys. Its main characteristic is the soft suspension setting (DCC).
 Sport	It represents the vehicle's default behaviour, suitable for dynamic driving.

Driving profile	Characteristics
 Cupra	It gives the vehicle a decidedly sportier nature, and makes for maximum performance.
 Individual	It allows you to personalise the configuration. The functions that can be adjusted depend on the equipment fitted in the vehicle.
 Offroad	Maintains optimal off-road driving by allowing the personalisation of the vehicle's configuration parameters.
 Snow	It adjusts the vehicle's behaviour for driving on slippery road surfaces, optimising grip and manoeuvrability.

#### **WARNING**

**When operating the Drive Profile, pay attention to all traffic: doing otherwise could cause an accident.**

#### **Note**

- **When the engine is switched off it will store the driving profile that was selected when the ignition was turned off. When restarting, the engine and the gearbox will start in their Comfort mode. To return the engine and gear to your desired mode, re-select the corresponding driving profile.**

- **Your speed and driving style must always be adjusted to visibility, weather, and traffic conditions.**

## Driving tips

### Running in

Please observe the instructions for running-in new components.

#### Running-in the engine

A new engine must be driven through a run-in period during its first 1500 kilometres (1000 miles). During its first few hours of running, the internal friction in the engine is greater than later on when all the moving parts have bedded down.

How the vehicle is driven for the first 1500 km (1000 miles) influences the future engine performance. Throughout the life of the vehicle, it should be driven at a moderate speed (especially when the engine is cold) this will reduce engine wear and increase its useful life. Never drive at extremely low engine speeds. Always engage a lower gear when the engine works "irregularly". **For the first 1000 km or 600 miles, please note:**

- Do not use full throttle.

- Do not force the engine above two thirds of its maximum speed.
- Do not tow a trailer.

**Between 1000 and 1500 kilometres (600 to 1000 miles)**, *gradually* increase power until reaching the maximum speed and high engine speeds.

### Running in new tyres and brake pads

- Replacement of wheel rims and new tyres >>> page 305.
- Information about brakes >>> page 245.

### For the sake of the environment

If the engine is run in gently, the life of the engine will be increased and the engine oil consumption reduced.

## Four-wheel drive (4Drive)

On four-wheel drive models, the engine power is distributed to all four wheels

### General notes

On four-wheel drive vehicles, the engine power is distributed to all four wheels. The distribution of power is controlled automatically according to your driving style and the road conditions. Also see >>> page 250.

The four-wheel drive is specially designed to complement the superior engine power. This combination gives the vehicle exceptional handling and performance capabilities, both on normal roads and in more difficult conditions, such as snow and ice. Even so (or perhaps especially for this reason), it is important to observe certain safety points >>> .

### Winter tyres

Thanks to four-wheel drive, your vehicle will have plenty of traction in winter conditions, even with the standard tyres. Nevertheless, we still recommend that winter tyres or all-season tyres be fitted on all *four* wheels to give even better *braking response*.

### Snow chains

On roads where snow chains are mandatory, this also applies to cars with four-wheel drive >>> page 309.

### Changing tyres

On vehicles with four-wheel drive, all four tyres must have the same rolling circumference. Also avoid using tyres with varying tread depths >>> page 305.

### Off-roader?

Your CUPRA vehicle is not an off-roader: it does not have enough ground clearance to

be used as such. It is therefore best to avoid rough tracks and uneven terrain as much as possible.

### WARNING

- Even with four-wheel drive, you should always adjust your speed to suit the conditions. Do not let the extra safety features tempt you into taking any risks when driving. Risk of accident!
- The braking capability of your vehicle is limited by the tyres' grip. It is therefore no different from a car without four-wheel drive. So do not be tempted to drive too fast on firm or slippery roads just because the vehicle still has good acceleration in these conditions. Risk of accident!
- On wet roads bear in mind that the front wheels may start to "aquaplane" and lose contact with the road if the car is driven too fast. If this should happen, there will be no sudden increase in engine speed to warn the driver, as occurs with a front-wheel drive car. For this reason you should always choose a driving speed suitable for the road conditions. Risk of accident!

## Economical and environmentally friendly driving

Fuel consumption, environmental pollution and wear to the engine, brakes and tyres all depend largely on driving style. >>>

Consumption can be reduced between 10-15% with an efficient driving type. The following section gives you some tips on lessening the impact on the environment and reducing your operating costs at the same time.

### Foresight when driving

If you think ahead when driving, you will need to brake less and thus accelerate less. Take advantage of the inertia of the vehicle whenever possible, with a **gear engaged**. This takes advantage of the engine braking effect, reducing wear on the brakes and tyres. Emissions and fuel consumption will drop to zero.

### Changing gear to save energy

An effective way of saving is to change *in advance* to a higher gear.

- Accelerate gradually and without reaching the “kick-down” position.

### Avoid driving at high speed

Avoid travelling at your vehicle’s top speed, whenever possible. Fuel consumption, emission of harmful gases and noise pollution multiply as speed is increased. Driving at moderate speeds will help to save fuel.

### Reduce idling time

In vehicles with the Start-Stop system idling is automatically reduced. In vehicles without the Start-Stop system it is worth switching off the engine, for example, at level crossings and at traffic lights that remain red for long periods of time. When an engine has reached operating temperature, and depending on the cylinder capacity, keeping it switched off for a minimum of about 5 seconds already saves more than the amount of fuel necessary for restarting.

The engine takes a long time to warm up when it is idling. Mechanical wear and pollutant emissions are also especially high during this initial warm-up phase. It is therefore best to drive off immediately after starting the engine. Avoid running the engine at high speed.

### Regular maintenance

Regular servicing helps in saving fuel even before the engine is started. A well-serviced engine gives you the benefit of **improved fuel efficiency** as well as maximum reliability and an enhanced resale value. A badly serviced engine can consume up to 10% more fuel than necessary.

### Avoid short journeys

The engine and catalytic converter need to reach their optimal **operating temperature**

in order to minimise fuel consumption and emissions.

A cold engine consumes a disproportionate amount of fuel. The engine reaches its working temperature after about four kilometres (2.5 miles), when fuel consumption will return to a normal level.

### Check tyre pressure

Always make sure the tyres are inflated to the correct pressures»» page 306 to save fuel. If the pressure is below half bar, fuel consumption may increase by 5%. Due to the greater rolling resistance, under-inflation **also** increases tyre wear and impairs handling.

Do not use **winter tyres** all year round as they increase fuel consumption by up to 10%.

### Avoid carrying unnecessary loads

Given that every kilo of extra **weight** will increase the fuel consumption, it is advisable make sure that no unnecessary loads are being transported.

Since the luggage rack increases the **aerodynamic drag** of the vehicle, you should remove it when not needed. At speeds of 100-120 km/h (62-75 mph), this will save 12% of fuel.



### Save electrical energy

The engine drives the alternator, thereby generating electricity. This implies that any increase in power consumption also increases fuel consumption! For this reason, switch off any unneeded electrical devices. Devices that use a lot of electricity include the blower at a high setting, the rear window heating or the seat heating.

#### Note

- If you have the Start-Stop system, it is recommended that it should not be disconnected.
- It is recommended that you close the windows when driving at more than 60 km/h (37 mph).
- Do not drive with your foot resting on the clutch pedal, as the pressure can make the plate slip. This causes wear and can damage the clutch plate.
- Do not ride the clutch on a hill, use the brake. The fuel consumption will be lower and you will prevent the clutch plate from being damaged.
- Use the engine brake on downhills by changing to the gear that is best suited for the gradient. Fuel consumption will be "zero" and the brakes will not suffer.

### Driving on flooded roads

To prevent damage to the vehicle driving on flooded roads, take the following into account:

- The water should never come above the lower edge of the bodywork.
- Drive at pedestrian speed.

#### WARNING

After driving through flooded zones, braking effectiveness can decrease if the brake discs or pads are damp >>> page 245.

#### CAUTION

- Driving through flooded areas may damage vehicle components such as the engine, transmission or electrical system.
- Whenever driving through water, the Start-Stop system must be switched off >>> page 199.

#### Note

- Check the depth of the water before entering the flooded zone.
- Do not stop in the water, drive in reverse, or stop the engine.
- Vehicles travelling in the opposite direction cause waves that could exceed your vehicle's critical height.

- Avoid driving through salt water (corrosion) >>> page 317.

### Trips abroad

- With petrol vehicles, it should be ensured that lead-free petrol is available throughout the journey >>> page 286, Fuel types. Seek information about service station networks selling unleaded fuel.
- In some countries, it is possible that your vehicle is not sold and some spare parts may not be available or the technical services may only be able to make limited repairs.

CUPRA distributors and importers will provide information about the technical preparation that your vehicle requires and also about necessary maintenance and repair possibilities.

#### CAUTION

CUPRA does not accept liability for any damage to the vehicle due to the use of a lower quality fuel, an inadequate service or the non-availability of genuine spare parts.

## Driver assistance systems

### General notes

#### Safety advice

##### WARNING

- Responsibility for driving rests with the driver at all times. The driver assistance systems are not a replacement for driver attention. Focus all your attention on driving and be prepared to intervene at all times.
- Use the driver assistance systems only when conditions allow. The driving style must always be suitable for the weather, visibility, road and traffic conditions.
- In order for driver assistance systems to react correctly, sensors and cameras must operate without limitations. Please read the notes on sensors and cameras in this chapter.

##### Note

- Keep in mind the specific rules of each country, especially when it comes to driving, formation of an emergency corridor, braking distance, speed, parking position, wheel position, etc. The driver is solely re-

sponsible for always complying with the specific regulations of each country.

- The area in front of and around the radar sensor should not be covered with adhesives, additional headlights or similar items, as this could have a negative impact on the operation of the assistants. If the vehicle is not properly repaired or structural modifications are made to it, the operation of the assistants may be affected.
- The repair and adjustment of sensors and cameras requires special knowledge and tools. It is recommended to visit a CUPRA dealership for this purpose.

#### System limits

##### WARNING

- Driver assistance systems can not overcome the laws of physics. Depending on the circumstances, a collision may not be avoidable.
- Warnings, notices and indicator lamps may not be displayed on time, or may be displayed incorrectly, e.g. if a vehicle approaches too quickly.
- Corrective interventions by driver assistance systems (e.g. interventions in the steering or brakes) may be insufficient or may never occur, depending on the circumstances. As a driver, you must be prepared to act at all times.

##### Note

- Due to the system's detection limits in the surroundings, the systems may not give warnings or intervene on time, or they might do so even if it is not desired. In addition, the auxiliary systems may incorrectly interpret a manoeuvre and, as a result, warn the driver in an unexpected manner.
- When the towing mode is selected, some assist systems may react with limitations, in an unusual way or may not be available. Keep in mind the instructions relating to the towing mode.

## Driver assistance sensors and cameras

### Front radar



**Fig. 143** On the front bumper: radar sensors.

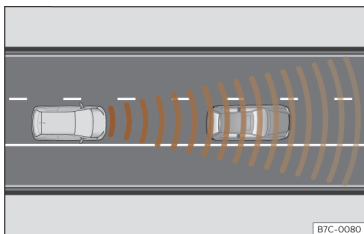

**Fig. 144** Detection area.

A radar sensor may be fitted to the front bumper of the vehicle»» **Fig. 143**. The front radar detects any objects in its detection

zone»» **Fig. 144** and provides support for the following functions:

- Front Assist»» page 223.
- Adaptive Cruise Control (ACC) »» page 226.

The radar can have a range of up to 120m (400ft) depending on road and weather conditions.

#### **⚠ WARNING**

The visibility of the radar sensor can be impaired by dirt or environmental influences such as rain, fog, snow, mud, dust, insects etc. In this case the Front Assist and ACC functions may stop working. The instrument panel displays the following message: **No sensor vision!** And the Front Assist unavailable or ACC unavailable warning lights come on.

- Clean the sensor area on the bumper as indicated in»» page 319, *Cleaning the exterior*. When the radar sensor starts correctly detecting again, the message disappears from the screen and the functions become available again.

#### **⚠ CAUTION**

- If the radar sensor is dirty or poorly adjusted, the Front Assist system may give unnecessary warnings and apply the brakes inappropriately.

- The operation of the radar can be affected by strong reflections of the emitted signal. This may occur, for example, in an enclosed car park or due to the presence of metallic objects (e.g. guard rails or sheets used in road works).

- The sensor may not be adjusted correctly if it receives an impact. This may compromise the system's efficacy or disconnect it. If you have the feeling that the radar sensor is damaged or adjusted incorrectly, switch off the Front Assist and ACC functions to avoid any damage. If this occurs have it adjusted.

### Front camera

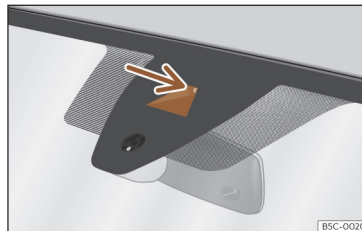

**Fig. 145** On the windscreen: field of vision of the Lane Assist system.

Depending on the equipment, the vehicle may be fitted with a front camera on the front windscreen»» **Fig. 145**. This camera

»

detects lane boundaries (lines) to provide support for the following functions:

- Lane Assist»» page 234 .
- Travel Assist»» page 236 .
- Emergency assist»» page 238 .

#### ⓘ CAUTION

To avoid affecting the operation of the systems, take the following points into consideration:

- Clean the field of vision of the camera regularly and make sure it is free of snow and ice.
- Do not cover the field of vision of the camera.
- Check that the windscreen is not damaged in the area of the camera's field of vision.

## Rear radar



**Fig. 146** Rear view of the vehicle: radar sensor zones.

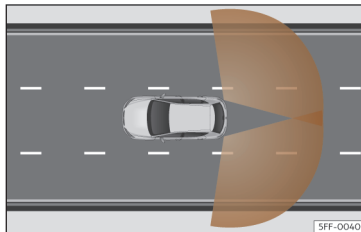

**Fig. 147** Sensor detection zones

The radar sensors are located on the left and right of the bumper and are not visible from the outside»» **Fig. 146** . The sensors monitor both the blind spot and traffic behind the vehicle»» **Fig. 147** .

They support the following functions:

- Lane departure warning (Side Assist) »» page 241.
- Rear cross traffic alert (RCTA)»» page 243 .

### Automatic deactivation of supported functions

The rear radar sensors deactivate automatically when, among other reasons, one of the sensors is detected to be permanently covered. This may be the case if, for example, there is a layer of snow or ice over one of the sensors.

The relevant text message will appear in the dash panel display.

#### ⓘ CAUTION

- The radar sensors on the rear bumper may be damaged or shifted in the event of a collision, for example, when entering or exiting a parking space. This may result in the system disconnecting itself, or at least possibly having its functionality diminished.
- In order to ensure that the radar sensors work properly, keep the rear bumper free of snow and ice and do not cover it.
- The rear bumper should only be painted with paint authorised by CUPRA. The lane departure warning's functions may be limited or work incorrectly if other paints are used.
- The visibility of radar sensors may be affected due to leaves, snow, strong haze or

dirt, among others. Clean the area in front of the sensors.

- Never use the lane departure warning, the rear cross traffic alert or the door opening warning if the radar sensors are dirty.

## Ultrasound sensors

The bumpers are fitted with ultrasound sensors to perform the following functions:

- Park Assist»» page 253.
- Parking aid Plus»» page 261.
- Rear parking aid»» page 264.

### ⓘ CAUTION

- Damage to the radiator grille, bumper, wheel arch and vehicle underbody can modify the orientation of the sensors. This can affect the parking aid function. Have the function checked by a specialised workshop.
- A number plate or number plate holder with dimensions that exceed the space for the number plate, or a cured or deformed number plate can cause false detections or a loss of visibility for the sensors.

### ⓘ Note

- In order to guarantee good operation, keep the sensors clean, free of snow and ice, and do not cover them with stickers or other objects.
- If you use high-pressure or vapour equipment for cleaning, do not apply it directly, unless you do so very briefly, and always keep a distance of more than 10 cm away.
- Fitting certain accessories to the front of the vehicle, such as a plate holder with advertising, may interfere with the operation of the Park Assist.

## Area View system

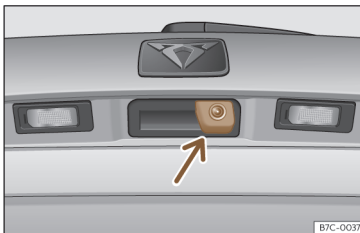

**Fig. 148** In the rear lid handle: Area View system

Depending on your vehicle's equipment, it can be fitted with 1 or 4 cameras that provide support to the following functions:

- Area View»» page 268
- Rear View Camera»» page 272.

### ⚠ WARNING

The use of a number plate may interfere in the views shown on the screen, since the cameras' field of vision may be reduced.

### ⓘ CAUTION

- In order to guarantee good system operation, keep the cameras clean, free of snow or ice, and do not cover them with adhesives or other objects.
- The vehicle is fitted with a cleaning system for the rear camera. To operate it, push the wiper lever away from the steering wheel (the camera will be cleaned at the same time as the rear window). If the camera is still dirty after using it, clean it manually.
- Never use abrasive cleaning products to clean the camera lenses.
- Do not use hot or warm water to remove ice or snow from the camera lenses. Doing so could damage the lenses.

## Cruise control system (CCS)

### Introduction

The cruise control system (GRA) helps maintain a constant speed set by you.

### Speed range

The cruise control system is available when driving in forward gear at a speed of over approx. 20 km/h (15 mph).

### Temporarily switching off the cruise control

The saved speed can be exceeded at any time, e.g. for overtaking. The cruise control is suspended during acceleration and is then resumed with the saved speed.

### Status display

When the cruise control system is switched on, the instrument cluster display shows the saved speed and the system status:

#### It lights up grey

The cruise control system is switched on, but regulation is not active.

#### It lights up green

The cruise control system is switched on and regulation is active.

If there is no speed saved, the instrument cluster display shows  instead of speed.

### Changing gears

As soon as the clutch pedal is depressed, regulation is suspended and resumes once the gear change has been made.

### Driving down slopes

Shift into a low gear before descending a long hill. This makes use of engine braking and relieves the brakes.

### WARNING

If it is impossible to drive with sufficient braking distance and at a constant speed, using the cruise control system may cause accidents and serious injuries may occur.

- Do not use Travel Assist when visibility is bad, on steep roads, on windy roads or in slippery circumstances (such as snow, ice, rain or loose gravel), or on flooded roads.
- Only use the cruise control system on paved roads with a firm surface.
- Adapt your speed and safety distance to the vehicle in front of you at all times to suit the visibility, weather, road and traffic conditions.
- After use, always switch off the speed limiter to prevent the speed being regulated against your wishes.

- It is dangerous to use a set speed which is too high for the prevailing road, traffic or weather conditions.

### Operating the cruise control

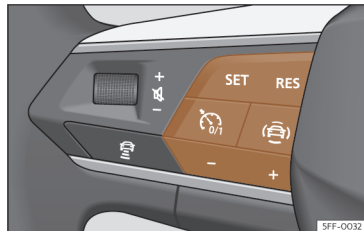

**Fig. 149** On the multifunction steering wheel: buttons to operate the speed limiter.

### Connecting

- Press the  button.

There is no speed saved and regulation is not yet operating.

### Start regulation

- When the vehicle is moving, press the button **SET**.

The cruise control system saves and regulates the current speed.

## Adjusting the speed

While the GRA is set, the stored speed can be adjusted:

- RES** + 1 km/h (1 mph)
- SET** - 1 km/h (1 mph)
- +** + 10 km/h (5 mph)
- - 10 km/h (5 mph)

The cruise control system only operates the acceleration, **it does not brake** the vehicle.

## Interrupting the adjustment

- Briefly press the button  on the multi-function steering wheel or press the brake pedal.

The speed is stored.

## Reinstating the cruise control

- Press the **RES** button.

The cruise control system resumes the saved speed and regulates it.

## Switching off

- Press and hold the button .

The cruise control system switches off and the saved speed is deleted.

## Switching off the speed limiter

- Press the  button.

- Select the speed limiter on the instrument cluster display.

The cruise control system is switched off.

## Problems and solutions

### Temporarily switching off the cruise control

The control lamp switches on yellow.

- Abnormal operation. Switch off the cruise control system and take the vehicle to a specialist workshop.

### The adjustment is interrupted unexpectedly

- If the clutch pedal is pressed for a long time.
- The vehicle has exceeded the saved speed for a long time.
- No forward gear has been selected.
- A brake assistance system has intervened, e.g. TCS or ESC.
- Front Assist has braked the vehicle.
- If the fault continues, disconnect the Emergency Assist and consult a specialised workshop.

## Speed limiter

### Introduction

The speed limited helps the driver not to exceed a set speed.

### Speed range

The speed limiter helps avoid exceeding a programmed speed, from 30 km/h (20 mph) approx. and faster.

### By selecting the speed limiter

The speed limitation can be interrupted at any time by depressing the accelerator pedal fully, beyond the point of resistance. As soon as the saved speed is exceeded, the green indicator light flashes and an audible warning signal sounds. The speed is stored.

The limiter is reactivated automatically after returning to less than the set speed.

### Status display

When the speed limiter is switched on, the instrument cluster display shows the saved speed and the system status:



It lights up grey

The speed limiter is switched on but regulation is not active. »

### It lights up green

The speed limiter is switched on and active.

### WARNING

After use, always switch off the speed limiter to prevent the speed being regulated against your wishes.

- The speed limiter does not relieve the driver of their responsibility to drive at the appropriate speed. Do not drive at high speed if not necessary.
- Using the speed limiter under adverse weather conditions is dangerous and can cause serious accidents, e.g. aquaplaning, snow, ice, leaves, etc. Only use the speed limiter when the status of the road and the weather conditions allow it.

## Operating the speed limiter

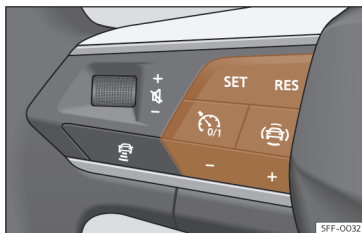

**Fig. 150** On the multifunction steering wheel: buttons to operate the speed limiter.

### Connecting

- Press the  button.

It does not take effect yet.

### Start regulation

- When the vehicle is moving, press the button **SET**.

The current speed is saved as a limit speed.

### Adjusting the speed

The programmed speed can be set:

- RES** + 1 km/h (1 mph)  
**SET** - 1 km/h (1 mph)  
**+** + 10 km/h (5 mph)

- - 10 km/h (5 mph)

### Interrupting the adjustment

- Press the  button.

The speed is stored.

### Reinstating the cruise control

- Press the **RES** button.

The limiter will re-activate as soon as the vehicle is moving at a speed lower than the saved one.

### Switching off

- Press and hold the button .

The speed limiter switches off and the speed is deleted.

### Switch to cruise control (GRA) or adaptive cruise control (ACC)

- Press the .
- Observe the corresponding message on the instrument cluster display.

The speed limiter is switched off.

## Problems and solutions

- ! LIM** The speed limiter is not active.



The control lamp switches on yellow.

- Malfunctions Switch off the speed limiter and go to a specialist workshop.

#### The adjustment is interrupted unexpectedly

- You have switched off the Electronic Stabilization Control (ESC).
- The brakes have overheated. Wait for the brakes to cool down and check the operation again.
- If the fault continues, consult a specialised workshop.

For safety reasons, the speed limiter only switches off fully whenever the driver stops pressing the accelerator pedal or switches the system off manually.

#### Not possible to start regulation

- The selected driving profile does not allow regulation to start. Select another profile and repeat the procedure.

## emergency brake assistance system (Front Assist)

### Introduction



**Fig. 151** On the instrument panel display: advance warning indications.

The objective of the system is to prevent head-on collisions against objects that may be in the vehicle's path or minimise the consequences of such impacts.

Depending on several factors and how critical the situation is, the system operates in a staggered manner. First it warns the driver, and if the driver's reaction does not occur or is insufficient, it activates independent emergency braking.

The function is intended to prevent collisions with parked vehicles or vehicles in the same lane travelling in the same direction, or with pedestrians crossing the vehicle's path or

travelling in the same lane and direction. It may not activate in other hazard situations »»

Front Assist is active between 4 km/h (2.5 mph) and 250 km/h (156 mph). Depending on a range of conditions, some of the functions described below are omitted to optimize the behaviour of the system.

**Front Assist is a driving assistance function that can never replace the driver's attention.**

#### Safety distance warning

If the system detects that you are driving too close to the vehicle in front, it will warn the driver with this indication on the instrument panel display

The timing of the warning varies according to other factors: driver behaviour and speed.

#### Advance warning

If the system detects a possible collision with the vehicle in front, it alerts the driver by means of an audible warning and an indication on the instrument panel display »» **Fig. 151.**

The warning moment varies depending on the traffic situation and driver behaviour. At the same time, the vehicle will prepare for a possible emergency braking »»

»

### Critical warning

If the driver fails to react to the **advance warning**, the system may actively intervene in the brakes and generate a brief jolt to warn the driver of the imminent danger of a collision.

### Automatic braking

If the driver also fails to react to the **critical warning**, the system may initiate independent emergency braking by progressively increasing the braking in accordance with how critical the situation is.

### Driver emergency brake assistance system

The system may detect that the driver is not braking hard enough to avoid the collision. In this case, it will increase the braking intensity.

The system cannot prevent a collision, although it can significantly minimise the consequences by reducing the speed and the force of the impact.

#### WARNING

Observe the safety warnings >>>  in Control and warning lamps on page 81.

#### WARNING

Front Assist cannot change the laws of physics or replace the driver in terms of

keeping control of the vehicle and reacting to a possible emergency situation.

#### WARNING

Following a Front Assist emergency warning, pay immediate attention to the situation and try to avoid the collision as applicable.

- If the Front Assist does not work as described in this chapter (e.g. it repeatedly intervenes unnecessarily), switch it off. Have the system checked by a specialised workshop. CUPRA recommends visiting a specialised CUPRA dealer or any SEAT dealership.
- Always adapt your speed and distance away from the vehicle in front of you at all times to suit visibility, weather, road and traffic conditions.
- The Front Assist alone cannot avoid accidents and serious injuries.
- In complex driving situations, Front Assist may issue warnings and intervene in braking unnecessarily.
- If the operation of the Front Assist is impaired by dirt or because the radar sensor has lost its settings, the system may issue unnecessary warnings and intervene inopportunely in the braking.
- The Front Assist does not react to animals or vehicles crossing your path or approaching head-on down the same lane.

- The Front Assist does not react to pedestrians walking head-on in the same lane.
- The driver must always be ready to take over the control of the vehicle.

#### Note

- When Front Assist is connected, the indications of other functions on the screen may be hidden.
- When the Front Assist causes a braking, the brake pedal is “harder”.
- Automatic interventions by the Front Assist on the brakes may be interrupted by pressing the clutch, accelerator or moving the wheel.
- The Front Assist may brake the vehicle until it stops completely. However, the brake system does not halt the vehicle permanently. Use the foot brake!
- If the Front Assist does not work as described in this chapter (e.g. in intervenes several times unnecessarily), switch it off.

## Operation of the emergency brake assistance system (Front Assist)

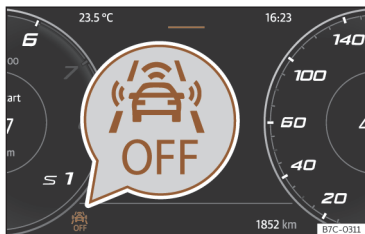

**Fig. 152** On the instrument panel display: Front Assist deactivated indication.

The Front Assist is active whenever the ignition is switched on.

When the Front Assist is switched off, so too are the **advance warning** and the **distance warning** functions.

CUPRA recommends leaving the Front Assist activated. Exceptions»» page 225, Deactivating Front Assist temporarily in the following situations.

### Switching the Front Assist on and off

With the ignition switched on, the Front Assist can be deactivated or activated as follows:

- Select the corresponding menu option using the button for the driver assistance systems»» page 79.
- **OR:** using the Infotainment system: press the function button > **Settings** > **Assistants**»» page 86.

When the Front Assist is deactivated, the indication »» **Fig. 152** will be displayed on the instrument panel.

### Activating or deactivating the pre-warning (advance warning)

The **advance warning** can be activated or deactivated in the infotainment system using the function button > **Settings** > **Assistants**»» page 86.

The system will store the setting for the next time the ignition is switched on.

CUPRA recommends keeping advance warning active.

Depending on the vehicle's infotainment system the **advance warning** function may be adapted in the following modes:

- Advance
- Medium

- Delayed
- Deactivated

CUPRA recommends driving with the function in "Medium" mode.

### Switching distance warning on and off

The safety distance warning can be activated or deactivated in the infotainment system using the function button > **Settings** > **Assistants**»» page 86.

The system will store the setting for the next time the ignition is switched on.

CUPRA recommends keeping the distance warning active.

## Deactivating Front Assist temporarily in the following situations

In the following situations the Front Assist should be deactivated due to the system's limitations:

- When the vehicle is to be towed.
- If the vehicle is on a test bed.
- When the radar sensor is damaged.
- If the radar sensor receives a violent impact.
- If it intervenes several times unnecessarily. »

- If the radar sensor is temporarily covered by an accessory.
- When the vehicle is going to be loaded on- to transportation.

### System limitations



**Fig. 153** On the instrument panel display: initial system self-calibration indication.

Front Assist has certain limitations inherent to the system. Thus, in certain circumstances, some of the reactions may be inappropriate from the driver's standpoint. So pay attention in order to intervene if necessary.

**The following conditions may cause the Front Assist not to react or to do so too late:**

- In the first few instants of driving after switching on the ignition, due to the system's

initial auto-calibration. During this period, a status icon»» **Fig. 153** is displayed.

- If the Front Assist is switched off or damaged.
- If the radar sensor is dirty or covered.
- On taking tight bends or complex paths.
- Pressing the accelerator all the way down.
- If the ASR has been disconnected or the ESC activated in **Sport** mode»» page 251.
- If the ESC is controlling.
- If several brake lights of the vehicle or electrically connected trailer are damaged.
- If there are metal objects, e.g. guard rails or sheets used in road works.
- If the vehicle is reversing.
- In case of snow or heavy rain.
- In case of narrow vehicles, such as motor-bikes.
- Misaligned vehicles.
- Vehicles crossing the other's path.
- Vehicles approaching in the opposite direction.
- Loads and accessories of other vehicles that protrude over the sides, backwards or over the top.

## ACC - Adaptive Cruise Control

### Introduction

**Adaptive Cruise Control (ACC) maintains a constant speed set by the driver. When approaching another vehicle in front, the ACC detects it and adapts the speed automatically, maintaining a distance set by the driver.**

### Does my vehicle have ACC?

Your vehicle has ACC if it has a configuration menu in the infotainment system»» page 86 and if it has the ACC function buttons on the multifunction steering wheel»» **Fig. 154**.

### Speed range

ACC regulates speeds between 30 km/h (20 mph) and 210 km/h (130 mph).

The ACC can brake vehicle until it stops completely before a vehicle that stops.

### Driver intervention prompt

- ⓘ ACC is subject to certain limitations inherent to the system. This means that the driver will have to control the speed and distance from other vehicles in certain situations. In this case, the instrument cluster display **will tell you to**

intervene by applying the brake, and an audio warning will be played.

### Radar sensors

The ACC uses the front radar technology. Read its maintenance instructions and information about its limitations»» page 216.

### ⚠ WARNING

The ACC's technology cannot overcome the system's inherent limitations or change the laws of physics. If used negligently or involuntarily, it may cause serious accidents and injuries. The system is not a replacement for driver awareness.

- Always be prepared to brake or accelerate.
- If you press the accelerator pedal the ACC will stop working. Therefore, it will not brake or request any braking intervention.
- Adapt your speed and safe distance to the vehicle in front of you at all times to suit visibility, weather, road and traffic conditions.
- Do not use the ACC in poor visibility, or on roads that are steep, with lots of curves or slippery.
- Never use ACC when driving off-road or on unpaved roads.
- The system does not react to stationary obstacles (such as a traffic jam queue). React soon enough to avoid a hazardous situation.

- The system does not react to people, animals or vehicles that are crossing or approaching in the opposite direction.
- If you are driving with a spare wheel fitted, the ACC system could automatically switch off. Switch off the system when starting off.
- Brake immediately if the ACC does not slow down enough.
- Brake immediately when a driver intervention instruction is displayed on the instrument cluster screen.
- If the vehicle continues to move involuntarily after a driver intervention prompt, brake the vehicle.

### **i** Note

If the ACC does not work as described in this chapter, do not use it until it has been checked by a specialised workshop. CUPRA recommends visiting a specialised CUPRA dealer or any SEAT dealership.

### ACC operation

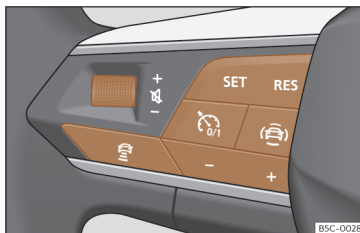

Fig. 154 On the multifunction steering wheel: buttons to operate the ACC

### Connecting

- Press the  button on the multifunction steering wheel.

The ACC does not regulate anything yet (standby).

### Start regulation

- To start regulation, press the button **SET** »» Fig. 154.

The ACC sets the current speed, or the closest speed within the valid range (30–210 km/h), as the cruise speed.

The gear lever must be in the **D**, **S** or **M** position.

Depending on the driving situation, the following indicator lamps come on: »



It lights up green

ACC connected, no vehicle detected in front.



It lights up green

ACC connected, vehicle detected in front.

When the ACC is in standby, the indicator lamps light up grey.

### Setting speed

To program the speed, press the + or - >>> **Fig. 154** buttons to the desired speed. The speed is adjusted at intervals of 10 km/h (5 mph).

When the ACC is active, the button **RES** can be pressed to increase the desired speed by 1 km/h (1 mph). You can then press **SET** to decrease it by 1 km/h (1 mph).

### Setting your distance level

The distance can be set to one of five levels, from very short to very long:

- Press the button and then the button + or - >>> **Fig. 154**.
- Alternatively, press the button as many times as necessary to set the desired distance.

Keep in mind each country's regulations on minimum braking distances.

### Suspend regulation (standby)

- Briefly press the button on the multi-function steering wheel or press the brake pedal.

The ACC indicator lamp is grey; the speed and distance are saved.

If the ESC or ASR is disconnected >>> page 251, the ACC is automatically suspended.

### Reinstating the cruise control

- Press the **RES** button. The ACC regulates to the last speed and distance setting.
- **OR:** Press the **SET** button to use the current speed.

### Switching off

- Press and hold the button . The set speed is cleared.

### Exceeding the speed regulated by the ACC

While driving with the ACC switched on, the driver can increase speed by pressing the accelerator pedal. ACC regulation is suspended until you release the accelerator pedal >>>

### Set the default distance setting

In the Infotainment system, you can pre-select the distance level when connecting the ACC from:

- Very short, Short, Medium, Long and Very long using the Infotainment system: > **Driver assistance > ACC >>>** page 86 .

### Changing the driving profile

*In vehicles with Drive Profile*, the driving profile selected can have an influence on the ACC's acceleration and braking behaviour >>> page 210.

*In vehicles without Drive Profile*, the behaviour of the ACC can also be affected if any of the following drive profiles are selected in the infotainment system in **Driver assistance**. ACC settings will be the same as those in the Drive Profile.



### WARNING

Before driving off, check that the road is clear. The radar sensor may not detect obstacles on the road. This could cause an accident and serious injuries. If necessary, apply the brake.



### CAUTION

If you increase speed using the accelerator pedal, the ACC may not be able to safely adjust the speed of the distance due to the limitations of the system.

- Be prepared to react if required by the situation.

## Status display

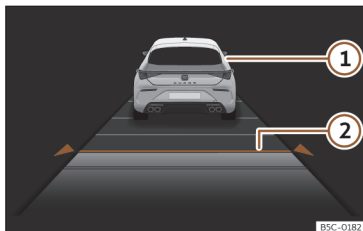

**Fig. 155** On the instrument panel display: ACC active.

- ① Vehicle ahead detected. It will light up if the distance to the vehicle is adjusted.
- ② Selected distance level 2.

This information can be displayed on the central panel of the **Assists** view, or in the left hand information profile >>> page 65 . If these views are not selected, it will be automatically displayed in the lower central part of the instrument cluster in a simplified manner.

The set speed will be displayed next to the function status indicator described in >>> page 227, **Start regulation**.

<sup>1)</sup> Or on the left, in countries that drive on the left hand side of the road.

## Special driving situations

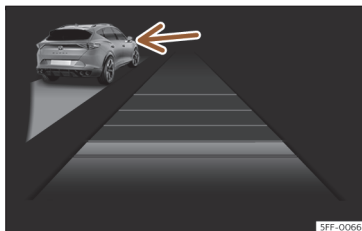

**Fig. 156** On the instrument panel display: ACC active, vehicle detected in an outer lane.

Be aware of the limitations and warnings described at the beginning of this chapter. >>> **⚠** in Introduction on page 227.

### Avoid undertaking on the right<sup>1)</sup>

If a vehicle is detected in the left lane that is travelling at a speed slower than that set by the driver, it will brake the vehicle within the comfort limits of the system to avoid passing it on the right >>> **Fig. 156** .

You can cancel this regulation by changing the set speed or by pressing the accelerator pedal.

The function works at speeds over 80 km/h (50 mph). It may not be available in certain countries.

### Overtaking

When the turn signal is switched on for overtaking, the ACC reduces the distance from the vehicle in front to help with the overtaking manoeuvre. The set cruising speed will not be exceeded.

The function works at speeds over 80 km/h (50 mph). It may not be available in certain countries.

### Stop&Go function

The ACC can bring the vehicle to a standstill (0 km/h) if the vehicle in front stops.

The ACC remains active and the message **ACC ready to start** is displayed on the instrument cluster for a few seconds. You can extend or reactivate this warning by pressing the button **RES** or, depending on your vehicle's equipment, by grabbing the steering wheel. During this time, the vehicle will move off again if the vehicle in front moves forwards. »

To move off when the message **ACC ready to start** is no longer displayed, once the vehicle in front has moved off:

- Press the accelerator pedal.
- **OR:** press the button **RES** or **SET** on the multifunction steering wheel.

The ACC is deactivated while stopped in the following cases:

- If the vehicle stops for several minutes.
- If a door is opened.

#### **⚠ WARNING**

If the message **ACC ready to start** is displayed on the instrument cluster display and the vehicle in front moves off, your vehicle will move off automatically. In this case, any obstacles in the road may not be detected. This may cause serious accidents and injuries.

- Always check the road before moving off, and apply the vehicle brakes yourself if necessary.

### ACC system limitations

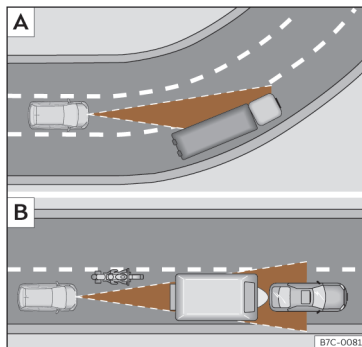

**Fig. 157** **A** Vehicle on a bend. **B** Motorcyclist ahead, out of range of the radar sensor.

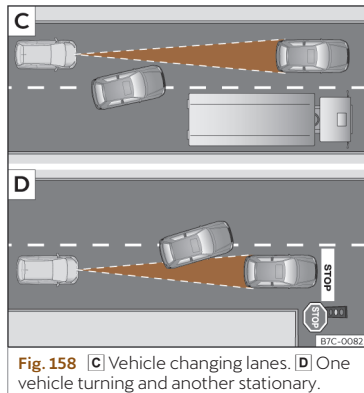

**Fig. 158** **C** Vehicle changing lanes. **D** One vehicle turning and another stationary.

The limits of the ACC system mean that it is not appropriate in all situations >>> **⚠** in Introduction on page 227.

CUPRA does not recommend using the function in the following cases >>> **⚠**:

- Heavy rain, snow or fog.
- When going through tunnels.
- In sections with roadworks.
- On routes with curves, e.g. on mountain roads.
- On off-road routes.
- In covered car parks.



- On roads with embedded metal objects such as train or tram tracks.
- On roads with loose gravel.

Pay special attention when using ACC in the following situations:

### On curves

The ACC may not detect the vehicle in front on a curve, or may regulate the distance from vehicles in other lanes»» Fig. 157 [A].

### Vehicles outside the sensor zone

In the following situations the ACC may not react, or may react slowly or inappropriately:

- Vehicles that are not aligned while driving or that are outside the sensor's detection area, such as motorcycles»» Fig. 157 [B]
- Vehicles that move into your lane, a short distance from your vehicle»» Fig. 158 [C].
- Vehicles with loads or accessories that protrude from the sides, rear or roof.

### Objects that are not detected

The ACC function only detects and reacts to vehicles moving in the same direction. Therefore it does not detect:

- People
- Animals

- Vehicles travelling in the opposite direction or crossing the road.
- Other stationary obstacles

The ACC does not react to stationary vehicles. If, for example, a vehicle detected by the ACC turns or moves over and there is a stationary vehicle in front of it, the ACC will not react to the second vehicle»» Fig. 158 [D].

### WARNING

Using the ACC in the above situations can cause serious accidents and injuries, and you could break the law.

## Problems and solutions

### ACC not available

The indicator lamp lights up yellow:

- The radar sensor is dirty or adjusted incorrectly. Take into account the warnings described at the beginning of this chapter »» page 217
- There is a fault or defect. Turn off the vehicle's ignition and turn it on again after a few minutes.
- If the problem persists, consult a specialised workshop.

### The ACC does not work as expected

- Make sure that the conditions are met for the radar sensor to operate properly »» page 217.
- If the brakes overheat, regulation stops automatically. Wait for them to cool down and check the operation again.
- Unusual noises during automatic ACC braking are normal and do not indicate any anomalies.

### The following conditions may lead the ACC not to react:

- The accelerator or brake is depressed.
- No gear is engaged or the vehicle is in gear R.
- The vehicle is reversing.
- ESC is operating.
- The driver is not wearing his/her seat belt.
- A vehicle or trailer brake light is faulty.
- The RPM is too high or too low.
- The parking brake is applied.
- Driving on an excessive slope.

## Proactive speed adjustment

### Introduction

The proactive speed adjustment adapts the speed to the speed limitations detected and to the road layout (curves, crossings, roundabouts, etc.).

Proactive speed adjustment is an additional function of the ACC»» page 226 and uses the traffic signal detection system »» page 72 and the navigation data of the infotainment system.

Proactive speed adjustment is available depending on the equipment, although not in all countries.

### WARNING

The proactive speed adjustment smart technology cannot overcome the limits imposed by the laws of physics and it only works within the limits of the system. Never allow the enhanced convenience of this function induce you to take any risk that compromises safety. If used negligently or involuntarily, it may cause serious accidents and injuries. The system is not a replacement for driver awareness.

- Always adapt your speed to suit visibility, weather, road and traffic conditions.

- Always pay attention to traffic and always keep the vehicle environment in mind.

• Always be prepared to adjust the speed yourself. If the traffic signal detection system is not working properly or the navigation data is not up to date, the speed may change unexpectedly and suddenly or may not suit the current traffic situation. In addition, the speed adjusted by the system may not suit your driving style.

• Always be prepared to adjust the speed yourself. If you drive without any active guided route, if you leave the route calculated by the navigation system or if the position of the vehicle cannot be determined correctly because the GPS does not provide accurate data, the speed may change unexpectedly and suddenly or may not adapt to the current traffic situation.

- Always use up-to-date navigation data.

• Always take into account the maximum permitted speed. In the case of speed limitations that are not included in the navigation data, the maximum permitted speed may be exceeded.

### Note

Also note the information related to the ACC relevant to safety»» page 226.

## Limitations of the proactive speed adjustment

In addition to the limitations of the traffic signal detection system»» page 72 and of the limitations of the ACC, proactive speed adjustment has the following limitations inherent to the system:

- Proactive speed adjustment only recognizes traffic signals that show a speed limitation. The proactive speed adjustment does not take into account, above all, the rules on priority of passage or traffic lights.
- On roads that are not included in the navigation data, or that are included with little accuracy, proactive speed adjustment is not available.
- If a speed limitation is notified based on the navigation data without it being detected by the traffic signal detection system, the indicated speed will be adjusted to the speed that was saved the last time.
- Proactive speed adjustment is not available for speed limitations below approx. 20 km/h (approx. 15 mph). In this case, a relevant message is displayed on the instrument panel screen.

## Activating the proactive speed adjustment

In the infotainment system, in the assist services menu, you can individually adjust the type of incident the vehicle should react to >>> page 86:

- Response to road layout.
- Reaction at permitted speeds.

## Driving with the proactive speed adjustment

- Connect the ACC >>> page 227.
- Set distance and speed.
- Activate the proactive speed adjustment.

As soon as the system recognises a speed limitation or a relevant road layout during the route, a warning will appear on the instrument panel display. This warning will indicate the reason and the speed to which the vehicle will adjust due to said limitation.

 Adjustment due to a speed limitation.

 Adjustment due to a road layout.

In the event of adjustment due to a speed limitation, the detected speed will be saved as the new desired speed. In the event of ad-

justment due to the road layout, the vehicle will accelerate again after leaving the reason for the adjustment behind and the speed will be adjustment to that which has been saved.

The speeds indicated for curves depend on the driving profile >>> page 210.

### Interrupting speed adjustment

- During the warning, press the button **RES**.
- During the adjustment, press the button **SET**.

### Adjust the announced speed

The announced speed can only be adjusted in the event of adjustment due to a speed limitation.

### Multifunction steering wheel:

**RES** + 1 km/h (1 mph), only while the ACC is adjusting

**SET** - 1 km/h (1 mph), only while the ACC is adjusting

**+** + 10 km/h (5 mph)

**-** - 10 km/h (5 mph)

If you adjust the indicated speed excessively, the proactive speed adjustment is interrupted.

### Note

- When a speed limitation is recognised, the proactive speed adjustment also adapts the saved speed even if the ACC is switched off. However, it will not adjust.
- If the speed of travel considerably exceeds the speed limit detected by the traffic signal detection system, a relevant warning is displayed in the instrument panel display.
- In the event of joining a highway without speed limitation, the recommended speed is automatically saved as the desired speed. If a higher speed has previously been saved for a motorway without a speed limit, this is used instead of the recommended speed.

## Problems and solutions

A message is displayed indicating that proactive speed adjustment is not currently available or not in your country.

- If this message is displayed for a long time and proactive speed adjustment is available in your country, contact a specialised workshop.

### Note

Depending on the anomaly in question, additional information may be displayed in **Vehicle status** >>> page 85.

## Lane Assist

### Introduction

The Lane Assist System helps the driver stay in his/her lane within the physical limits of the system. This function is not suitable and is not designed to keep the vehicle automatically in the lane.

Using the camera located in the windscreen, the Lane Assist system detects the limits (lane lines) dividing the lanes in which the vehicle is travelling. If the vehicle gets too close to the detected lane limits, the system alerts the driver through a corrective motion of the steering wheel. The driver can cancel the steering corrective action at any time.

No warning is produced with the turn signals activated, given that the Lane Assist system understands that a lane change is required.

### System limits

Use the Lane Assist system only on large, well-maintained motorways and highways.

The system is not available under the following conditions:

- The driving speed allowed is below approx. 55 km/h (30 mph).
- The system has not detected any lane lines.

- On tight bends.
- Temporarily in very sporty driving situations.

### WARNING

The intelligent technology in the Lane Assist system cannot change the limits imposed by the laws of physics and by the very nature of the system. Careless or uncontrolled use of the Lane Assist system may cause accidents and injury. The system is not a replacement for driver awareness or manoeuvres when driving.

- Always adapt your speed and the distance to the vehicles ahead in line with visibility, weather conditions, the condition of the road and the traffic situation.
- Always keep your hands on the steering wheel so it can be turned at any time. The responsibility of staying in the lane is always the driver's.
- The Lane Assist system does not detect all road markings. The road surfaces, road structures or objects in poor condition can be incorrectly detected as road markings under certain circumstances by the Lane Assist system. Immediately counter any unwanted intervention of the system.
- Please observe the indications on the instrument panel and act as is necessary if the traffic situation permits.
- In the following situations there may be undesired interventions of the system or it

may be that the system does not intervene at all. In these situations, special attention is required from the driver and, where appropriate, the temporary deactivation of the lane assist warning system:

- In very sporty driving situations.
- In adverse weather conditions and roads in poor condition.
- When passing through areas undergoing works.
- Before gradient changes of grade and river beds.
- Always observe the vehicle surroundings carefully and drive proactively.
- When the area of vision of the camera becomes dirty, covered or is damaged, the Lane Assist system function can be affected.

### Control lamp



It lights up green

Lane Assist system active and available.



It lights up yellow

The Lane Assist system intervening with a rectification of the steering.

Some control and warning lamps will light up briefly when the ignition is switched on to

check certain functions. They will switch off after a few seconds.

### ⚠ WARNING

Observe the safety warnings >>> ⚠ in Control and warning lamps on page 81.

## Driving with the Lane Assist System

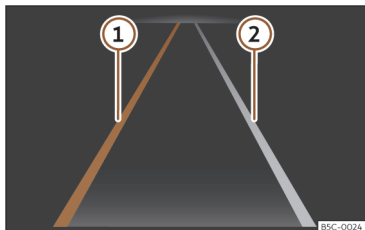



**Fig. 159** On the instrument panel display: indications of the Lane Assist System.

- ① Lane line detected. The system intervenes assisting on the represented side.
- ② Lane line detected. The system does not intervene.

### Switching the lane assist system on or off

In some countries, the Lane Assist System is always activated when the ignition is switch-

ed on. The connection status is shown in the **Driver assistance** menu of the Infotainment system or the driver assistance systems menu after pressing the corresponding button. The Lane Assist system can be activated and deactivated in these menus.

The Lane Assist system is ready to actively intervene as of approximately 60 km/h (35 mph) and if it has detected the lane limits (system status: active). The control lamp  emits a green light. When the system intervenes by rectifying the direction, the control lamp  emits a yellow light.

If the control lamp of the instrument panel display is off, it means that the Lane Assist system is connected but not ready to intervene or it is disconnected.

When you activate a turn signal, the system temporarily goes into a passive state in order to allow manual lane change.

An energetic rotation or rectification of the steering wheel by the driver causes the system to temporarily switch to a passive state.

### Driver intervention prompt

If the steering is not corrected manually, the system prompts the driver through an indication on the instrument panel display and acoustic warnings.

If no reaction is obtained from the driver, the system switches to a passive state.

Regardless of the steering manoeuvres, through an indication on the instrument panel display and acoustic warnings, the driver is also prompted to drive through the centre of the lane if the steering correction lasts more than reasonable.

### Steering wheel vibration

The following situations may result in a steering wheel vibration:

- The lane ceases to be recognised during a sudden intervention in the direction of the system.

It is also possible to select steering wheel vibration in the **Assistants** menu of the infotainment system. In this case, when a vehicle with Lane Assist switched on crosses over a detected lane marking, the steering wheel will vibrate.

## Troubleshooting

### Error message, the system disconnects

- Clean the windscreen. >>> page 317
- Check that the windscreen is not damaged in the area of the camera's field of vision. »

### System behaviour is different than expected

- Clean the field of vision of the camera regularly and make sure it is free of dirt, snow and ice.
- Do not cover the field of vision of the camera.
- Check that the windscreen is not damaged in the area of the camera's field of vision.
- Do not mount objects on the steering wheel.

In the event of doubts or queries, go to a specialised workshop.

## Driving Assist (Travel Assist)

### Introduction

The driving assist (Travel Assist) combines adaptive cruise control (ACC) and adaptive lane guidance. Within the limitations of the system, the vehicle can maintain a distance from the vehicle in front that is preselected by the driver and remain in the preferred position within the lane.

Travel Assist uses the same sensors as Adaptive Cruise Control (ACC) and Lane Assist. Therefore, carefully read the information about the ACC»» page 226 and the Lane Assist»» page 234 and take into account the

limitations of the systems and the indications given in the information.

### Speed range

Travel Assist adjusts at speeds between approx. 30 km/h (approx. 20 mph) and approx. 210 km/h (approx. 130 mph); in the case of the adaptive lane guidance function, between 0 km/h (0 mph) and approx. 250 km/h (approx. 155 mph).

### Driving with Travel Assist

Travel Assist automatically controls the accelerator pedal, the brakes and the steering. In addition, Travel Assist may, within its limitations, decelerate the vehicle until it stops behind another that stops and automatically starts again.

You can override assisted adjustment at all times.

### How to know if the vehicle is fitted with Travel Assist

The vehicle is fitted with Travel Assist if the multifunction steering wheel has the button »» Fig. 162.

### Driver intervention prompt

If you remove your hands from the steering wheel, after a few seconds the system asks you to take over the steering with an indica-

tion on the instrument panel display and acoustic warnings.

### WARNING

The Travel Assist smart technology cannot overcome the limits imposed by the laws of physics and it only works within the limits of the system. If Travel assist is used negligently or involuntarily, it may cause serious accidents and injuries. The system is not a replacement for driver awareness.

- Bear in mind the system limitations and the indications regarding the control of the Adaptive Cruise Control (ACC) and Lane Assist.
- Adapt your speed and safety distance to the vehicle in front of you at all times to suit visibility, weather, road and traffic conditions.
- Do not use Travel Assist when visibility is bad, on steep roads, on windy roads or in slippery circumstances (such as snow, ice, rain or loose gravel), or on flooded roads.
- Do not use Travel Assist offroad or on roads where the surface is not firm. Travel Assist has been designed for use on paved roads only.
- Travel Assist does not react to people or animal or vehicles crossing your path or which approach you head-on in the same lane.
- Brake immediately if Travel Assist does not slow down enough.

- Brake immediately when a braking message is displayed on the instrument panel screen.
- Brake when, after an indication to brake, the vehicle rolls without it being desired.
- Keep your hands on the steering wheel at all times, to ensure you have control over the steering at all times. The driver is always responsible for keeping the vehicle in its own lane.
- If possible, do not wear gloves while driving. The system could interpret this as no driving activity.
- If driver intervention is requested on the instrument panel display, immediately resume control of the vehicle.
- Always be prepared to adjust the speed yourself.

## Indications on the instrument panel display

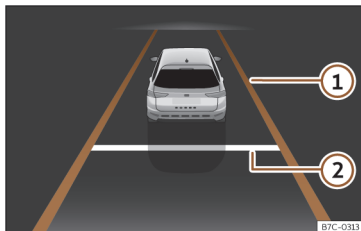

**Fig. 160** On the instrument panel display: indication with active adjustment.



**Fig. 161** On the instrument panel display: control lamps.

### Displays on the screen

>>> **Fig. 160**

- ① The adaptive lane guidance function is active.

- ② Distance set.

In addition, depending on the equipment, control lamps indicate the status of the system on the instrument panel display:

>>> **Fig. 161**

- A Travel Assist active, adaptive cruise control and adaptive lane guidance function are active.
- B Travel Assist active, adaptive cruise control active and adaptive lane guidance function passive.
- C Travel Assist active, adaptive cruise control passive and adaptive lane guidance function active.
- D Travel Assist active, adaptive cruise control and adaptive lane guidance function are passive.
- E Inactive Travel Assist.

Depending on the equipment, more details may be displayed on the instrument cluster, such as dashed lines or other vehicles on the road.

## Operating Travel Assist

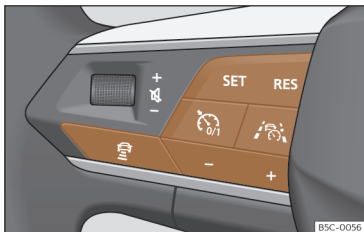

**Fig. 162** Left side of the multifunction steering wheel: buttons for operating Travel Assist.

### Connecting

- Press the  button on the multifunction steering wheel.

The control lamp  will light up green. The following warning is also displayed on the instrument panel screen: The Travel Assist maintains the current speed and the preset distance from the vehicle in front. At the same time, if it detects road markings it keeps the vehicle in the lane by moving the steering wheel.

### Interrupting the adjustment

- Briefly press the button  on the multifunction steering wheel or press the brake pedal.

The set distance remains saved.

### Making other adjustments

For all else, Travel Assist is operated like the ACC >>> page 227.

## Problems and solutions

### Travel Assist is not available or does not work as expected

The control lamp switches on yellow. A relevant warning is also displayed on the instrument panel screen.

- There is a fault in the sensors. Check the causes and solutions described in >>> page 217.
- The system limits are exceeded.
- If the fault continues, consult a specialised workshop.

### Take the wheel

The warning lamp comes on white or red, depending on the urgency of the intervention. A message is also displayed.

- You released the steering wheel for a few seconds. Take hold of the steering wheel and take control of the vehicle.

- The system limits have been reached. Take hold of the steering wheel and take control of the vehicle.

### Travel Assist disconnects automatically

*Vehicles without Emergency Assist:* You have released the steering wheel for a long period.

- Abnormal operation. Contact a specialised workshop.

### The adjustment is interrupted unexpectedly

*Vehicles without lane departure warning:* You have turned on the turn signal.

## Emergency Assist

### How it works

**Emergency Assist can detect whether there is inactivity by the driver and can automatically keep the car within the lane and stop it altogether if necessary. This way the system can actively help avoid an accident or reduce its consequences.**

Emergency Assist uses the same sensors as Adaptive Cruise Control (ACC) and Lane Assist. Therefore, carefully read the information about the ACC >>> page 226 and the



Lane Assist»» page 234 and take into account the limitations of the systems and the indications given in the information.

If the Emergency Assist detects that the driver does not perform any activity, it requests that the driver take control of the vehicle. To do this, it emits optical and acoustic warnings and causes braking jolts. The seat belt is tightened (depending on the equipment). The system slows down the vehicle and keeps it in its lane.

You can cancel the adjustment at any time by moving the steering wheel, over-accelerating or braking.

While the emergency assistant is in operation, other road users are warned as follows:

- The hazard warning lights are switched on soon after.

The following happens as soon as the vehicle stops:

- The electronic parking brake is activated.

The Emergency Assist is only activated if the following requirements are met:

- The adaptive cruise control (ACC) must be switched on .
- The Travel Assist or the Lane Assist are switched on.

- The system has detected a road lane marking on both sides of the vehicle.

### Troubleshooting

#### Emergency Assist not available

The control lamp switches on yellow. A relevant warning is also displayed on the instrument panel screen.

- The field of vision of the camera is dirty. Clean the windscreen.
- The visibility of the camera is diminished due to weather factors, e.g. snow, or detergent residue or some coating. Clean the windscreen.
- The visibility of the camera is diminished due to accessories or adhesives. Leave the area around the camera's field of vision free.
- The camera has been altered or damaged, e.g. because of damage caused to the windscreen. Check for visible damage.
- There is a fault or defect. Turn the drive system off and on again.
- If the fault continues, disconnect the Emergency Assist and consult a specialised workshop.

#### WARNING

The smart technology fitted into the Emergency Assist cannot overcome the limits imposed by the laws of physics; it only

works within the limits of the system. The driver is responsible for driving the vehicle.

- Adapt your speed and safety distance to the vehicle in front of you at all times to suit the visibility, weather, road and traffic conditions.
- The Emergency Assist cannot always avoid accidents or serious injuries by itself.
- If possible, do not wear gloves while driving. The system could interpret this as no driving activity.
- If the radar sensor or the camera are covered or have been altered or damaged, the system may intervene on the brakes or on the direction in an inappropriate manner.
- The Emergency Assist does not react to people or animal or vehicles crossing your path or which approach you head-on in the same lane.

#### WARNING

If the Emergency Assist Intervenes inopportunistically, serious accidents and injuries may occur.

- If the vehicle behaves differently than expected, interrupt the intervention of the Emergency Assist by over-accelerating, braking or moving the steering wheel.
- Do not use Travel Assist or Lane Assist. Have the system checked by a specialised workshop.

»

**Note**

- Automatic interventions by the Emergency Assist on the brakes may be interrupted by pressing the accelerator or brake or by moving the wheel.
- Hazard warning lights that come on automatically can be switched off by pressing the accelerator or the break, moving the steering wheel or pressing the hazard warning light switch.
- If this occurs, the Emergency Assist may decelerate the vehicle until it comes to a complete stop.
- When the Emergency Assist is activated, it is only available again after the ignition has been switched off and back on again.

## Side Assist with Rear Cross Traffic Alert (RCTA)

### Introduction

The lane departure warning (LCA) helps detect traffic that is at the rear of the vehicle.

The rear cross traffic alert (RCTA) helps the driver when backing out of a parallel parking spot and when manoeuvring.

**WARNING**

The smart technology incorporated into the blind spot detector (BSD) with parking assistance (RCTA) included cannot overcome the limits imposed by the laws of physics; it only works within the limits of the system. Accidents and severe injury may occur if the blind spot detection system or the rear cross traffic alert are used negligently or involuntarily. The system is not a replacement for driver awareness.

- Adapt your speed and safe distance to the vehicle in front of you at all times to suit visibility, weather, road and traffic conditions.
- Keep your hands on the wheel at all times to be ready to intervene in the steering at any time.
- Pay attention to the indicator lamps that may come on in the external rear view mirrors and on the instrument cluster, and follow any instructions they may give.
- The lane departure warning could react to any special constructions that might be present to the sides of the vehicle, e.g. high or irregular dividers. This may cause erroneous warnings.
- Never use the lane departure warning on unpaved roads. The lane departure warning has been designed for use on paved roads.
- Always pay attention to the vehicle's surroundings.

- The control lamps of the lane departure warning may have limited functionality due to solar radiation.

**Note**

If the blind spot detector with parking assistant does not work as described in this chapter, stop using it and contact a specialised workshop.

## Control lamp



**Fig. 163** Control lamp of the lane departure warning.



**Fig. 164** Control lamp of the lane departure warning.

**indicator lamp in external rear view mirrors:**

## It lights up

It turns on once briefly: the lane departure warning is activated and ready to operate, i.e. when activating the system.

It lights up continuously: the lane departure warning has detected a vehicle in the blind spot.

## Flashes

A vehicle has been detected in the adjacent lane and the turn signal has been engaged in the direction of the detected vehicle >>> ⚠.

For vehicles that are also equipped with Lane Assist >>> page 234, a warning to switch lanes will also appear even though the turn signal has not been engaged (Lane Assist "Plus" >>> page 242).

The control lamps light up when the ignition is switched on and should turn off after approximately 2 seconds. This is the time taken for the function check.

If there are no indications from the control lamp of the lane departure warning, this means that the lane departure warning has not detected any other vehicles at the rear area >>> ⚠.

When the exterior lighting is low, the intensity with which the control lamps come on is dimmed. The user can modify the intensity of the control lamps with up to 5 levels in the infotainment system menu.

## ⚠ WARNING

If the warning lamps and the corresponding messages are ignored when they light up, the vehicle may stall in traffic and cause accidents and severe injuries.

- Never ignore the warning lamps or messages.
- Carry out the necessary operations.

## ⓘ CAUTION

Failure to heed the control lamps and corresponding text messages when they light up may result in damage to the vehicle.

## Lane departure warning (Side Assist)

The lane departure warning uses radar sensors to monitor the areas behind the vehicle >>> page 7. The system does this by measuring the vehicle's distance from other vehicles and its speed differential. The lane departure warning will not work at speeds of less than approx. 15 km/h (9 mph). The system uses optical signals in the external rear view mirrors to notify the driver.

The lane width is not detected individually, but is rather pre-configured in the system. Thus if you are driving in wide lanes or in between two lanes, the indications may be incorrect. Furthermore, the system can detect »

vehicles driving in the lane next to you (if there are any), and can also detect stationary objects such as dividers, and thus give an incorrect indication.

## Indication on the exterior mirror

The control lamp provides an indication on the corresponding side regarding the traffic situation behind the vehicle, if it is deemed to be critical. The control lamp of the left-hand side»» **Fig. 163** indicates the traffic situation to the rear left of the vehicle, and the control lamp of the right-hand side»» **Fig. 164**, indicates the traffic situation to the rear right of the vehicle.

In the case of retrofitted tinted windows or windows with tinted film, the indications of the external mirrors may not be seen clearly or correctly.

Keep the external mirrors clean and free of snow and ice, and do not cover them with adhesives or other similar materials.

## Lane assist Plus.

The Lane Assist Plus function can be used by activating the **Lane Assist**»» page 234 and **Side Assist** functions. In this case its functions are expanded as described below.

If the driver initiates a lane change manoeuvre in a potential critical situation:

- The lamp flashes in the corresponding rear-view mirror even though the turn signal has not been activated.
- The steering wheel vibrates to warn the driver of the risk of collision.
- torque is applied to correct the steering and return the vehicle to its lane.

## Driving situations

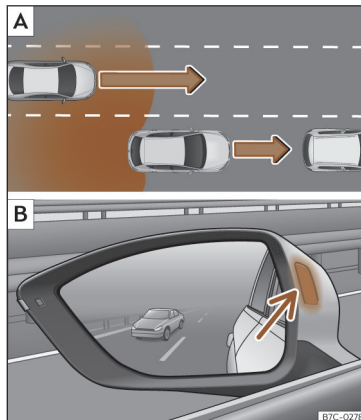

**Fig. 165** Schematic representation: **[A]** Passing situation with traffic behind the vehicle. **[B]** Indication from the blind spot detector in the left-hand external mirror.

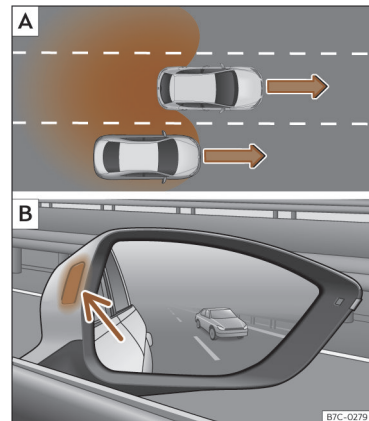

**Fig. 166** Schematic representation: **[A]** Situation of passing and then moving into the right-hand lane. **[B]** Indication from the blind spot detector in the right-hand external mirror.

In the following situations, an indication will be displayed in the external mirror»» **Fig. 165 [B]** (arrow) or»» **Fig. 166 [B]** (arrow):

- When being overtaken by another vehicle»» **Fig. 165 [A]**.
- When passing another vehicle»» **Fig. 166 [A]** with a speed differential of approx. 10 km/h (6 mph). If the vehicle is passing at a

considerably higher speed, no indication will be displayed.

The faster the vehicle approaches, the sooner an indication will be displayed in the external mirror, because the blind spot detector takes into account the speed differential with other vehicles. Thus even though the distance from the other vehicle is identical, the indication will appear sooner in some cases and later in others.

### Physical limitations inherent to the system

In some situations the lane departure warning may not interpret the traffic situation correctly. I.e. in the following situations:

- on tight bends;
- in the case of lanes with different widths;
- in areas with significant gradient changes;
- in adverse weather conditions;
- in the case of special constructions to the side of the vehicle, e.g., high or irregular dividers.

### Rear cross traffic alert (RCTA)



**Fig. 167** Schematic representation of the rear cross traffic alert assistant: zone monitored around the vehicle while leaving a parking space.

Park Assist uses the radar sensors on the rear bumper»» page 217 to monitor the traffic crossing behind the vehicle as it backs out of a parallel parking space or as it is being manoeuvred, for example in very low visibility conditions.

When the system detects a relevant vehicle on the road that is approaching the rear of the vehicle»» Fig. 167, an acoustic alarm may sound if the relevance so requires it.

In addition to the acoustic alarm, the driver is also informed by means of a visual signal on infotainment system display. This signal is

displayed in the form of a red or yellow strip at the back of the image of the vehicle on the infotainment system screen. This strip displays the side of the vehicle towards which traffic is approaching in transverse direction<sup>1)</sup>.

### Automatic braking to reduce damages

If the rear cross traffic alert detects that someone else on the road is approaching the rear of the vehicle and the driver does not step on the brake, the system will engage the brakes automatically.

The parking system helps the driver by automatically engaging the brakes to reduce any damage. The automatic intervention on the brakes takes place when driving in reverse at approx. 1-12 km/h (1-7 mph). After detecting that the vehicle is stationary, the system keeps it that way for around 2 seconds.

After automatically braking to reduce damage, the system will not be able to automatically brake again for approximately 10 seconds.

You can interrupt the automatic braking by stepping hard on the accelerator pedal or the brake pedal in order to regain control of the vehicle. »

<sup>1)</sup> It is only displayed if the vehicle is equipped with a parking system.

**⚠ WARNING**

The smart technology incorporated into the rear cross traffic alert cannot overcome the limits imposed by the laws of physics; it only works within the limits of the system. The parking assistant function should not tempt you into taking any risks. The system is not a replacement for driver awareness.

The parking assistant function should not tempt you into taking any risks. The system is not a replacement for driver awareness.

- The system should never be used in limited visibility conditions or complicated traffic, e.g., in high-traffic areas or when crossing multiple lanes.
- Be sure to always be aware of the vehicle's surroundings, since the system often fails to detect things such as bicycles or pedestrians.
- The rear cross traffic alert itself will not brake the vehicle to a complete stop.

**Managing the assist systems****Enabling and disabling the assist systems**

The blind spot detector with parking assistant can be switched on and off by accessing the **Assistance systems** menu on the dash panel display using the steering wheel controls. If the vehicle is equipped with a multi-function camera, it can also be accessed by means of the driver assistance systems key located on the main beam headlight lever.

Open the **Assistants** menu.

- Side Assist
- Rear cross traffic alert

If the verification box on the instrument panel or the infotainment system is checked , the functionality will be automatically activated when switching on the ignition.

When the blind spot detector is ready to operate, the indications in the external mirrors will turn on briefly as confirmation.

When the vehicle is restarted, the last adjustment in the system will remain active.

**Trailer mode**

The Blind spot detector and the rear cross traffic alert will be automatically deactivated and it will be impossible to activate them if the tow hitch is electrically connected to a trailer or other similar object.

As soon as the driver starts to drive with a trailer connected electrically to the vehicle, a message will appear on the instrument panel display indicating that the blind spot detector and the rear cross traffic alert are deactivated. Once the trailer has been unhitched from the vehicle, if you want to use the blind spot detector and the rear cross traffic alert, you will have to reactivate them in the corresponding menu.

If the towing hitch is not factory equipped, then the blind spot detector and the rear

cross traffic alert will have to be deactivated manually when driving with a trailer.

## Braking and parking

### Braking system

#### Control lamps

##### It lights up red

Brake fluid level too low»» page 297 or fault in the brake system.

 Do not carry on driving!

##### It lights up red

Electronic parking brake»» page 247.

The warning lamp turns off when the handbrake is released.

##### It lights up green

Auto Hold function activated»» page 248.

##### It lights up yellow

Front brake pads worn.



Contact a specialised workshop immediately.

#### WARNING

• When the ignition is switched on, the status of the brake system and the brake assist functions is automatically checked. The control lights on the instrument cluster light up briefly and then turn off again. If a warning light stays on permanently, there is

a fault. Seek qualified technical assistance immediately.

• If the brake warning lamp  does not go out or if it lights up when driving, the brake fluid level in the reservoir is too low so there is a risk of an accident»» page 297, Brake fluid. Stop the vehicle and do not drive on. Obtain technical assistance.

• If the brake warning lamp lights up  together with the ABS lamp  this could be due to an ABS fault. When this function fails, the rear wheels can lock up. Under certain circumstances, the rear of the vehicle may skid, with the danger of losing control. Stop and seek technical assistance.

• If the  lamp lights up, alone or accompanied by a warning message on the instrument panel display, please go immediately to a specialised workshop to check the brake pads and to replace them if they are worn.

#### Information about the brakes

##### New brake pads

For the first 200 to 300 km (100 to 200 miles), new brake pads have not yet reached their maximum braking capacity, and need to be “run in” first. However, you can compensate for the slightly reduced braking effect by applying more pressure on the brake

pedal. Avoid overloading the brakes while running them in.

##### Wear

The rate of wear on the **brake pads** depends a great deal on how you drive and the conditions in which the vehicle is operated. This is a particular problem in urban traffic and short stretches, or with very sporty driving.

Depending on the speed, the braking force and the environmental conditions (e.g. temperature, air humidity, etc.) noises may be produced when braking.

##### Wet roads or road salt

In certain situations (for example, on driving through flooded areas, in severe downpours or after washing the vehicle) the braking action could be delayed if the discs and pads are damp, or frozen in winter. In this case the brakes should be “dried” by pressing the brake pedal several times.

At high speed and with the windscreen wipers activated, the brake pads will briefly touch the brake discs. This takes place, although unnoticeable to the driver, at regular intervals to improve the response time of the brakes when they are wet.

The effectiveness of the brakes can also be temporarily reduced if the vehicle is driven for some distance without using the brakes when there is a lot of salt on the road in



winter. The layer of salt that accumulates on the discs and pads can be removed by gently applying the brakes a few times.

### Corrosion

There may be a tendency for corrosion to form on the discs and dirt to build up on the brake pads if the vehicle is used infrequently or the brakes are not used very often.

If the brakes are not used frequently, or if rust has formed on the disks, it is advisable to clean off the pads and disks by braking firmly a few times at a moderately high speed »» .

### Fault in the brake system

If the brake pedal travel should ever increase *suddenly*, this may mean that one of the two brake circuits has failed. Drive immediately to the nearest specialised workshop and have the fault repaired. Drive there slowly and remember that you will have to apply more pressure on the brake pedal and allow for longer stopping distances.

### Low brake fluid level

Malfunctions can occur in the brake system if the brake fluid level is too low. The brake fluid level is monitored electronically.

### Brake servo

The brake servo increases the pressure you apply to the brake pedal. It works only when the engine is running.

#### WARNING

Any anomaly in the brake system can increase the braking distance, with the resulting risk of an accident.

- New brake pads and discs must be run in and do not have the correct friction during the first 200 km (124 miles). This reduced braking capacity may be offset by pressing on the brake pedal a little harder.
- If you are driving on roads which have been salted, braking effectiveness may be decreased.
- Brakes can overheat if used excessively on slopes. Before driving down a long steep slope, it is advisable to reduce speed and change down into a lower gear or range. Therefore, using the engine brake relieves the brakes.
- Gentle continuous braking causes the brakes to overheat and the braking distance will increase. Apply and then release the brakes alternately.
- Apply the brakes heavily to clean the brake system only in a suitable traffic situation. Do not put other road users in danger: there is risk of causing an accident.
- Ensure the vehicle does not move while in neutral, when the engine is stopped. The

braking distance is increased considerably when the brake servo is not active.

- If the brake is subjected to high stresses, vapour bubbles may form in the brake system's pipes. This reduces the efficiency of the brakes.
- Non-standard or damaged front spoilers could restrict the airflow to the brakes and cause them to overheat. Before purchasing accessories please read the relevant instructions.

#### CAUTION

- Never let the brakes "drag" by leaving your foot on the pedal when it is not necessary to brake. This overheats the brakes, resulting in longer stopping distances and greater wear.
- Before driving down a long, steep gradient, it is advisable to reduce speed and select a lower gear. This makes use of engine braking and relieves the brakes. If you still have to use the brakes, it is better to brake firmly at intervals than to apply the brakes continuously.

#### Note

- If the brake servo is out of action, for example when the car is being towed, you will have to press the brake pedal considerably harder than normal to make up for the lack of servo assistance.



- If you wish to equip the vehicle with accessories such as a front spoiler or wheel covers, it is important that the flow of air to the front wheels is not obstructed, otherwise the brakes can overheat.

### Electronic parking brake



**Fig. 168** In the lower part of the centre console: electronic parking brake button

The electronic parking brake replaces the handbrake » .



#### Applying the electronic parking brake

The electronic parking brake can be activated whenever the vehicle is at a standstill, even when the ignition is switched off. Activate it whenever you leave or park the vehicle.

- Pull and hold the  **Fig. 168** button.

- The parking brake is activated when the control light of button » **Fig. 168** (arrow) is on and the red  control lamp on the instrument panel is always on.
- Release the button.

#### Disconnecting the electronic parking brake

- Switch the ignition on.
- Press the button  » **Fig. 168**. At the same time step hard on the brake pedal or, if the engine is running, press the accelerator pedal slightly.
- The control lamp of button » **Fig. 168** (arrow) and the red  control lamp on the instrument panel go out.

#### Automatic release of the electronic parking brake upon moving off

The electronic parking brake is automatically switched off when starting if, after the driver's door is closed and the driver's seat belt fastened, **any** of the following situations take place:

- A gear range is engaged or switched to another one and the accelerator pedal is lightly pressed.
- To facilitate certain manoeuvres there are exceptions that allow the automatic parking brake to be released without the driver's seat belt being fastened.

The parking brake can be prevented from being automatically released by continuously pulling up the  » **Fig. 168** switch when starting off.

The electronic parking brake is not disconnected until the  button is released. This can facilitate starting off when a heavy load is towed » page 274.

#### Automatic activation of the electronic parking brake when exiting the vehicle incorrectly

In vehicles with automatic transmission, the electronic parking brake is activated automatically when exiting the vehicle incorrectly if:

- The selector lever is in the **D/S** or **R** position or in the Tiptronic selector gate.
- **AND:** the vehicle is stationary.
- **AND:** the driver door is open.

#### Emergency brake function

Only use the emergency brake function if you are unable to stop the vehicle with the foot brake » .

- Pull and hold the  » **Fig. 168** button in this position to **forcefully** brake the vehicle. At the same time, an acoustic warning can be heard. »

- To stop the braking process, release the  button or press the accelerator.

### WARNING

The improper use of the electronic parking brake can cause accidents and serious injury.

- Never use the electronic parking brake to stop the vehicle, unless it is an emergency. Braking distances can be considerably longer, since, under certain circumstances, only the rear wheels brake. Always use the foot brake.
- Never accelerate from the engine when a gear range or a gear is engaged and the engine is running. The vehicle could move, even if the electronic parking brake is activated.
- When the electronic parking brake is switched on or off, there is a slight movement of the brake pedal. Be careful not to position your foot under the pedal.

### CAUTION

To prevent the vehicle from unintentionally moving when parking it, first apply the electronic parking brake and then remove your foot from the brake pedal.

### Note

- If the vehicle battery is flat, it will not be possible to disconnect the electronic parking brake. Use the jump-start»» page 50.
- When the electronic parking brake is applied or released, noises may be heard.
- The system performs automatic and audible tests sporadically in the parked vehicle if some time elapses without the electronic parking brake being used.

## Auto Hold Function

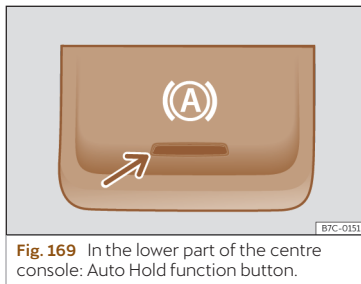

**Fig. 169** In the lower part of the centre console: Auto Hold function button.

The indicator lamp of the  **Fig. 169** button remains on when the Auto Hold function is connected.

Once connected, the Auto Hold function assists the driver in keeping the vehicle station-

ary at repeated intervals or for a certain period of time with the engine running, for example, when going up a slope, when stopped at traffic lights or in heavy traffic with intermittent stops.

When connected, the Auto Hold function automatically prevents the vehicle from rolling when stationary without pressing the brake pedal.

After detecting that the vehicle is stationary and the brake pedal has been released, the Auto Hold function holds the vehicle. The driver can lift their foot off the brake pedal.



When the driver touches the accelerator pedal or accelerates slightly to continue driving, the Auto Hold function releases the brake. The vehicle moves according to the slope of the road.

If the vehicle is stationary and one of the conditions required by the Auto Hold function is impaired, it disconnects itself and the button's control light goes out»» **Fig. 169**. The electronic parking brake connects automatically, if necessary, to park the vehicle safely»» .

### Conditions for keeping the vehicle stationary with the Auto Hold function

- The driver door must be closed.
- The driver's seat belt must be fastened.
- The engine is running.

### Switching the Auto Hold function on and off

Press the  button  $\ggg$  . The control lamp on the button goes out when the Auto Hold function is switched off.

### Automatically engaging and disengaging the Auto Hold function

If the Auto Hold function was switched on via the  button before switching the ignition off, the function will remain on the following time the ignition is switched on.

If the Auto Hold function was not switched on, it will automatically remain off next time the ignition is engaged.

**The Auto Hold function connects automatically if the following conditions are met** (all points must be met at the same time  $\ggg$  ):

1. The vehicle is kept **stationary** with the brake pedal on a flat surface or on a slope.
2. The engine rotates “correctly”.

**The Auto Hold function is automatically turned off if the following conditions are met:**

1. If any of the conditions mentioned on  $\ggg$  page 248, Conditions for keeping the vehicle stationary with the Auto Hold function are no longer met.

2. If the engine is running irregularly or an anomaly is detected.
3. If the engine is turned off or stalls.
4. If the accelerator is pressed
5. If any of the tyres has only minimal contact with the ground, e.g. in the case of axle articulation.

### WARNING

The smart technology incorporated into the Auto Hold function cannot defy the laws of physics; it only works within the limits of the system. The greater convenience provided by the Auto Hold function should never tempt you to take any risk that may compromise safety.

- Never leave the vehicle running and with the Auto Hold function switched on.
- The Auto Hold function cannot always keep the vehicle stationary uphill or downhill or stop it sufficiently, for example, on slippery or frozen surfaces.

### Note

Before entering a car wash, always switch off the Auto Hold function, because if the electronic parking brake is automatically connected, it may cause damage.

## Stabilisation and brake assistance systems

### Control lamps

#### It lights up

Fault in the ESC or ABS, or disconnection caused by the system.

The ESC works in combination with the ABS. If the ABS fails, the lamp also lights up.

#### Flashes

ESC or ASR activated.

#### It lights up

ESC manually deactivated.

Or: ESC in Sport mode  $\ggg$  page 251.

#### It lights up

ABS faulty or does not work.

### WARNING

When the ignition is switched on, the status of the brake system and the brake assist functions is automatically checked. The control lights on the instrument cluster light up briefly and then turn off again. If a warning light stays on permanently, there is  $\ggg$

**a fault. Seek qualified technical assistance immediately.**

## Brake assist systems

### Electronic Stability Control (ESC)

The ESC helps to improve safety. It reduces the tendency to skid and improves the stability and roadholding of the vehicle. The ESC detects critical handling situations, such as vehicle understeer or oversteer, or wheel-spin on the driving wheels. It stabilises the vehicle by braking individual wheels or by reducing the engine torque. The warning lamp will flash on the instrument panel when the ESC is intervening .

The ESC includes the anti-lock brake system (ABS), the hydraulic brake assist (HBA), the traction control system (ASR), electronic differential lock (EDS), electronic torque control (XDS) and tractor-trailer sway mitigation.

ESC also helps stabilise the vehicle by changing the torque.

The ASR can be deactivated when wheel spin is desirable»» page 251.

### Anti-lock brake system (ABS)

ABS prevents the wheels from locking up under braking until the vehicle has reached a virtual standstill. You can continue to steer

the vehicle even when the brakes are on full. Keep your foot on the brake pedal and do not pump the brakes. You will feel the brake pedal pulsate while the ABS is working.

If the running gear or brake system is modified, the effectiveness of the ABS could be severely limited.

### Hydraulic Brake Assist (HBA)

The brake assist system can reduce the required braking distance. The braking force is automatically boosted if you press the brake pedal quickly in an emergency. You must keep pressing the brake pedal until the danger has passed.

### Traction control system (ASR)

In the event of the wheels spinning, the ASR reduces the engine torque to adapt to the road condition. This helps the car to start moving, accelerate or climb a gradient.

### Electronic differential lock (EDL)

When the EDL detects wheelspin, it brakes the spinning wheel and directs the power to the other driven wheel. This function is active up to approximately 100 km/h (62 mph).

To prevent the disc brake of the braked wheel from overheating, the EDL cuts out automatically if subjected to excessive loads. The vehicle can still be driven. The EDL will

switch on again automatically when the brake has cooled down.

### Tractor-trailer sway mitigation

If the vehicle is pulling a trailer, it will control the following: tractor-trailers tend to sway. When the swaying of the trailer is felt by the vehicle and detected by the ESC, it will automatically brake the towing vehicle within the limits of the system and mitigate the sway. Tractor-trailer sway mitigation is not available in all countries»» page 280.

### Electronic engine torque management (XDS)

When taking a curve, the driveshaft differential allows the outer wheel to turn at a higher speed than the inner wheel. In this way, the wheel that is turning faster (outer wheel) receives less drive torque than the inner wheel. This may mean that in certain situations the torque delivered to the inner wheel is too high, causing the wheels to spin. On the other hand, the outer wheel is receiving a lower drive torque than it could transmit. This can cause a loss of grip on the drive axle, in this case the front axle, which results in understeer or "lengthening" of the trajectory.

The XDS can detect and correct this effect via the sensors and signals of the ESC.

Via the ESC, the XDS will brake the inside wheel and counter the excess driving torque

of that wheel. This means that the requested trajectory is much more precise.

XDS works in combination with the ESC and is always active, even when ASR is switched off, or when the ESC is in Sport mode or disconnected.

### Multi-collision brake

The multi-collision brake consists of automatic braking activated by the Airbag control unit. It is activated when, in the event of an accident, the Airbag control unit detects decelerations above the activation level, and braking is managed by the ESC system.

In the event of an accident, the multi-collision brake can help the driver by braking to avoid the risk of skidding during the accident and causing other collisions.

The following actions control automatic braking during the accident:

- When the driver presses the accelerator, the automatic braking does not take place.
- When the braking pressure through pressing the brake pedal is greater than the system's braking pressure the vehicle will brake automatically.
- Multi-collision braking will not be available if there is an anomaly in the ESC system.

### WARNING



Driving at high speed on icy, slippery wet ground can result in loss of vehicle control and serious injury to the driver and passengers.

- The ESC, ABS, ASR, EDS and the electronic torque control systems cannot exceed the limits imposed by the laws of physics. Always bear this in mind, especially on wet or slippery roads. If you notice the systems cutting in, you should reduce your speed immediately to suit the road and traffic conditions. Do not be encouraged to take risks by the presence of more safety systems. If you do, an accident may occur.
- Please remember that the accident risk always increases if you drive fast, especially in corners or on a slippery road, or if you follow too close behind the vehicle in front of you. The ESC, ABS, brake assist, EDS and the electronic torque control system cannot prevent accidents: risk of accidents!
- Accelerate with caution on slippery surfaces (for example, icy or snow-covered). Despite the control systems, the driven wheels could spin, affecting the stability of the vehicle: risk of accident!

### Note

- The ABS and ASR will only operate correctly if the four wheels have identical tyres. Any differences in the rolling radius

of the tyres can cause the system to reduce engine power when this is not desired.

- The regulating processes of the systems can make noises due to their operation.
- If the warning lamp  or  lights up, there could be a fault >>> page 80 .
- Any modifications made to the vehicle (for example, to the engine, brake system, running gear or to the combination of wheels and tyres) may affect the operation of the ABS, ASR and EDS.

## Connecting and disconnecting the ESC

The ESC is switched on automatically when the engine is started, and only works when the engine is running and includes the ABS, EDS and ASR systems.

### Disconnecting and connecting the ESC in "Sport" mode

- In "Sport" mode, the ESC can be disconnected and connected using the infotainment system >>> page 82 . In vehicles with a driver information system the corresponding indication will be displayed.

When "Sport" mode is connected, the ESC interventions are limited and the ASR is completely disconnected. In addition, the  control lamp lights up on the instrument panel. »

### Disconnecting and connecting the ESC

In some versions of the model, besides the traction control system (ASR), the electronic stability programme (ESC) can also be switched off.

- The ESC can be switched on and off in the infotainment system: press  > **Driver assistance > ESC menu** >>> page 86. In vehicles with a driver information system the corresponding indication will be displayed.

When the ESC is disconnected the control warning lamp  lights up on the instrument panel.

### ESC in "Offroad" mode

Turn the Driving Experience button to select the Offroad mode and connect it >>> page 211. The interventions of the ASR, as well as of the EDS and the ABS system adapt to irregular terrain.

In the following exceptional situations it may make sense to activate the Offroad mode to allow the wheels to spin:

- When "swinging" the vehicle to get it unstuck.
- Driving in deep snow or on loose surfaces.
- When driving on rough terrain with much of the car's weight is lifted off the wheels (axle articulation).

- Steep descents with braking on unpaved terrain.

For your safety we recommend that you turn off the Offroad mode when it is not absolutely necessary.

To **disconnect** the "Offroad" mode, select a different driving mode.

### ESC in "Snow" mode

Turn the Driving Experience button to select the "Snow" mode and connect it >>> page 211. Traction control system (ASR) interventions adjust to the adhesion of snowy roads.

To **disconnect** the "Snow" mode, select a different driving mode.

#### WARNING

The ESC Sport mode should be activated only when traffic conditions and the ability of the driver allow it. Danger of skidding!

- With ESC in Sport mode, the stabilising function will be limited to allow for a sportier drive. The driving wheels could spin and the vehicle could skid.
- If the ESC is deactivated, the vehicle stabilisation function is not available.

#### WARNING

You should only activate the Offroad Mode or disable the ASR if the experience of the

driver and traffic conditions allow it. Danger of skidding!

- With the Offroad mode activated, the stabilisation function is limited. In particular, if the road is too smooth and slippery, the driving wheels could spin and the vehicle could skid.

#### Note

- If the ESC Sport mode is selected, the cruise control system will be switched off.
- In ESC OFF mode, the ESC will be temporarily reactivated to assist the driver during braking and will then switch back to passive mode when the brake pedal is released (depending on the model version).

## Parking

### To park the vehicle

When parking your vehicle, all legal requirements should be observed.

Always note the following points when parking the vehicle:

- Park the vehicle on a suitable surface >>> .
- Connect the electronic parking brake >>> page 247.
- Set the selector lever to the P position.

- Stop the engine and turn off the ignition. Turn the steering wheel slightly to engage the steering lock.
- When leaving the vehicle, take all keys with you.

#### Additionally, on steep slopes and inclines

Before switching off the engine, rotate the steering wheel so that if the vehicle should move, it will be held by the kerb.

- On slopes, turn the front wheels so that they are against the edge of the kerb.
- Uphill, turn the wheels towards the centre of the road.

#### WARNING

- Avoid parking the vehicle where the hot exhaust system could ignite inflammable materials, such as dry grass, low bushes, spilled fuel or flammable materials.
- Do not leave passengers inside a closed vehicle, they may not be able to open doors or windows. Locked doors hinder the possibility of a rescue.
- Children should not be left alone in the vehicle. They could tamper with the handbrake or the gears, which could cause the vehicle to move without control.
- Depending on weather conditions, it may become extremely hot or cold inside the vehicle. This can be fatal.

## Help with parking and manoeuvring

### Assisted parking system (Park Assist)

#### Introduction

The parking assist system is an additional function of the ParkPilot»» page 259 and helps the driver find a suitable parking space from among the following types:

- park driving in reverse in suitable perpendicular and parallel spaces,
- park driving forwards in suitable perpendicular spaces,
- exit a parking space driving forwards from a parallel space.

In vehicles with a Park Assist system and factory infotainment system, the front, rear and side areas are represented, and the position of obstacles is shown relative to the vehicle.

The Park Assist system is subject to certain limitations inherent to the system and its use requires special attention by the driver »» .

#### WARNING

The technology used in the park assist system involves a series of limitations inherent

in the actual system and in the use of ultrasonic sensors. The use of Park Assist should never tempt you to take any risk that may compromise safety. The system is not a replacement for driver awareness.

- Any accidental movement of the vehicle could result in serious injury.
- Adapt your speed and driving style at all times to suit visibility, weather, road and traffic conditions.
- Certain surfaces of objects and garments do not reflect the ultrasound sensors' signals. The system cannot detect, at least correctly, these objects or people wearing such clothes.
- Ultrasound sensor signals may be affected by external sound sources. In certain circumstances this may prevent them from detecting people or objects.
- The ultrasound sensors may have blind spots in which obstacles and people are not detected.
- Monitor the area around the vehicle at all times, since the ultrasound sensors do not detect small children, animals or certain objects in all situations.

#### WARNING

Quick turns of the steering wheel when parking or exiting a parking space with Park Assist can cause serious injury. »»

- Do not hold the steering wheel during manoeuvres to park or exit a parking space until the system requests it. Doing so disables the system during the manoeuvre, resulting in the parking being cancelled.

### ⓘ CAUTION

- In certain circumstances, the ultrasonic sensors do not detect objects such as trailer tongues, bars, fences, posts or thin trees, or an open (or opening) rear lid, which could damage the vehicle.
- Retrofitting of certain accessories to the vehicle, such as a bicycle rack, may interfere with the operation of the Park Assist system and cause damage.
- The Park Assist system uses as a reference parked vehicles, curbs and other objects. Make sure that the tyres and wheels are not damaged while parking. If necessary, opportunely interrupt the parking manoeuvre to avoid damaging the vehicle.
- The ultrasound sensors on the bumper may be damaged or shifted in the event of a collision, for example, when entering or exiting a parking space.
- If you use high-pressure or vapour equipment to clean the ultrasound sensors, do not apply it directly unless very briefly and always from a distance of more than 10 cm.
- A registration plate or plate holder on the front with larger than the space for the reg-

istration plate, or a registration plate that is curved or warped can cause:

- False detections.
  - The sensors to lose visibility.
  - Cancellation of the parking manoeuvre or defective parking.
- If one of the ultrasonic sensors is damaged, the area corresponding to that group of sensors (front or rear) is deactivated and cannot be activated until the fault is corrected. However, you can still use the sensors of the other bumper as per usual. If there is a fault in the system, consult a specialist workshop. To do so, CUPRA recommends going to a specialised CUPRA dealer or any SEAT dealership.

### ⓘ Note

- In order to guarantee good system operation, keep the ultrasound sensors of the bumper clean, free of snow or ice, and do not cover them with adhesives or other objects.
- Certain sources of noise, such as rough asphalt or paving stones and the noise of other vehicles can induce the Park Assist system or ParkPilot to give erroneous warnings. The presence of metal objects can also affect the manoeuvre.
- To become familiar with the system and its functions, CUPRA recommends that you practice operating the Park Assist system in

an area where there is not too much traffic or in a car park.

## Description of the parking assist system



**Fig. 170** In the upper part of the centre console: button to switch on the Park Assist system.

The components of the Park Assist system are the ultrasonic sensors located in the front and rear bumpers, the **P** button to switch the system on and off and the messages on the instrument cluster display.

### Prerequisites for parking

- The traction control system (ASR) must be turned on»» page 251.
- Speed when passing next to the parking space (parallel parking): do not exceed approx. 40 km/h (25 mph).



- Speed when passing next to the parking space (angle parking): do not exceed approx. **20 km/h (12 mph)**.
- Keep a distance between **0.5 and 2.0 metres** when driving past the parking space.
- Space length (parallel parking): **vehicle length + 0.8 meters**.
- Space width (angle parking): **vehicle width + 0.8 meters**.
- Do not exceed approximately **7 km/h (4 mph)** when parking.

### Requirements for leaving the parking space (only for parallel parking)

- The traction control system (ASR) must be turned on >>> page 251.
- Space length: **length of the vehicle + 0.5 metres**.
- Do not exceed approximately **7 km/h (4 mph)** when exiting the parking space.

### Prematurely stopping or automatically interrupting the manoeuvres for parking or exiting a parking space

Park Assist interrupts the manoeuvres for parking or exiting a parking space in any of the following cases:

- Press the **P@** button.
- The speed exceeds approximately **7 km/h (4 mph)**.

- The driver takes control of the steering wheel.
- The parking manoeuvre does not end within 6 minutes from the activation of automatic steering.
- There is a fault in the system (the system is temporarily unavailable).
- The ASR is disconnected.
- ASR or ESC intervene with regulation.
- The driver door is opened.

To restart the manoeuvre it is necessary that none of these things occur and that the **P@** button is pressed again.

### Special characteristics

The Park Assist system is subject to certain limitations inherent to the system. For example, it is therefore not possible to enter or exit a parking space on sharp bends.

While entering or exiting a parking space, a brief signal sounds to prompt the driver to change between forward and reverse gears (depending on the case). In successive manoeuvres, the assistant tells the driver to change gears, at the latest, when the continuous audible signal is given (object present at a distance of  $\leq 30$  cm) by Park Pilot.

When the Park Assist system turns the steering wheel with the vehicle stationary, the instrument panel also displays the symbol .

Keep the brake pedal depressed while the symbol remains on the dash panel display to turn the wheels with the vehicle stopped. This way, the system will require fewer manoeuvres to complete the parking action.

### Trailer mode

The Park Assist system cannot be switched on if the factory-fitted towing bracket >>> page 274 is electrically connected to a trailer.

### After changing a wheel

If, after changing a wheel, the vehicle stops entering and exiting parking spaces correctly, the circumference of the new wheel may be different and the system may need to adapt to it. The adaptation is automatic and takes place during driving. Making turns slowly and in both directions (20 km/h [12 mph]) for a few minutes may contribute to this adaptation process >>>  in Introduction on page 253.

## Selecting a parking mode



**Fig. 171** On the instrument panel display: view of the parking assist system with reduced view.

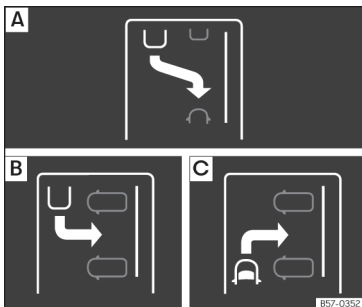

**Fig. 172** On the instrument panel display: indication of parking modes.

Park assist has 3 parking modes:

- A** Reverse parallel parking.
- B** Reverse angle parking.
- C** Forward angle parking.

### Selecting a parking mode after passing in front of the space

After activating the Park Assist system and after detecting a parking space, the display on the instrument panel proposes a parking mode. The Park Assist system selects the parking mode automatically. The selected mode is shown on the instrument panel display >>> **Fig. 171**. The reduced display of other possible parking modes is also shown >>> **Fig. 172**. If the mode selected by the system does not correspond to the desired mode, you can select another mode by pressing the **P** button >>> **Fig. 170**.

- The necessary conditions to park with Park Assist have to be met >>> page 254 .
- Press the **P** button.
- A control lamp on the **P** button lights up when the system is switched on. Additionally, the selected parking mode is shown on the instrument panel display and the reduced display shows another parking mode it can be changed to.
- Turn on the corresponding turn signal towards the side of the road where you are parking. The instrument panel displays the side corresponding to the road. By default, if

the turn signal is not on, it parks on the right in the direction of traffic.

- If necessary, press the **P** button again to change to the next parking mode.
- Once you have switched to all possible parking modes, if the **P** button is pressed again, the system switches off.
- Press the **P** button again to switch the system back on.
- Follow the instructions displayed on the instrument panel while paying attention to traffic and drive the vehicle past the parking space.

### Special case of perpendicular parking space to park forwards without driving past first

- The necessary conditions to park with Park Assist have to be met >>> page 254 .
- Move forward towards the parking space while paying attention to traffic and stop the vehicle with the front part partially inside the parking space.
- Press the **P** button *once*.
- A control lamp on the **P** button lights up when the system is switched on. Additionally, the selected parking mode is shown on the instrument panel display without reduced display.
- Release the steering wheel >>> **⚠** in Introduction on page 253.

## Parking with the parking assist system

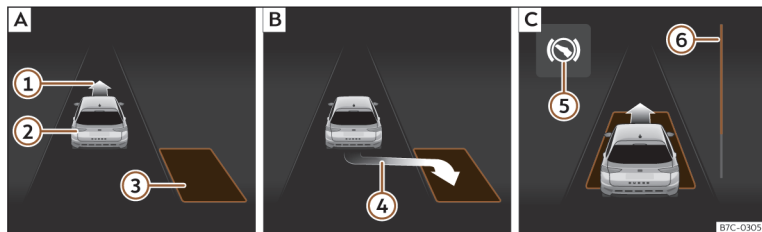

**Fig. 173** On the instrument panel display: parallel parking. **[A]** Finding a parking space. **[B]** Parking position. **[C]** Manoeuvring.

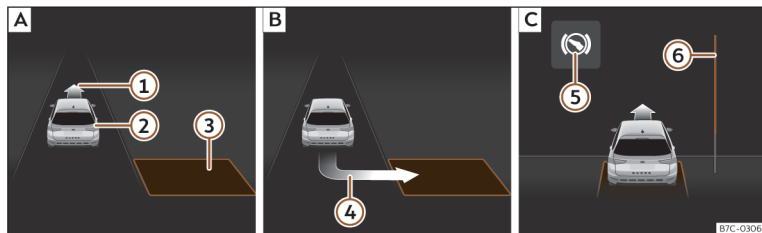

**Fig. 174** On the instrument panel display: angle parking. **[A]** Finding a parking space. **[B]** Parking position. **[C]** Manoeuvring.

- ① Message to move forwards
- ② Your vehicle
- ③ Parking space detected
- ④ Message to park
- ⑤ Message to press the brake pedal
- ⑥ Progress bar

The necessary conditions have to be met to park with Park Assist >>> page 254 and the

parking mode must be selected >>> page 256.

#### Parking

- Look at the display on the instrument panel to see if the space has been detected as “appropriate” and if the correct position for parking has been reached >>> **Fig. 173 [B]** or >>> **Fig. 174 [B]**. The space is considered

“appropriate” if the display on the instrument panel shows the message to park ④.

- Stop the vehicle and, after a brief pause, engage the reverse gear.
- Release the steering wheel >>> ⚠ in Introduction on page 253.
- Please note the following message: **Intervention in active direction. Watch your surroundings!**. While you keep >>

watch around you, carefully start accelerating up to no more than 7 km/h (4 mph). During the parking manoeuvre, the system **only** takes charge of the steering. **You, as the driver, have to accelerate, engage the clutch if necessary, change gears and brake.**

- Reverse until the continuous ParkPilot signal sounds; **OR:** reverse until the indication to move forward appears on the instrument panel display >>> Fig. 173 [C] or >>> Fig. 174 [C]; **OR:** reverse until the **Park Assist finished** message appears on the instrument panel display. The progress bar ⑥ indicates the distance to cover >>> page 258.
- Press the brake pedal until the parking assist system completes the steering wheel turns; **OR:** until the symbol (S) goes out on the instrument panel screen.
- Select first gear.
- Move forward until the continuous ParkPilot signal sounds; **OR:** move forward until the reverse indication appears on the instrument panel display. The Park Assist system steers the vehicle forward and back until it centres it in the space >>> Fig. 173 [C] or >>> Fig. 174 [C].
- For best results, wait at the end of each manoeuvre until the Park Assist system has finished turning the steering wheel. The parking manoeuvre ends when a corresponding message is displayed on the instrument panel and, in some cases, an acoustic signal sounds.

### Progress bars

The progress bar >>> Fig. 173 ⑥ and >>> Fig. 174 ⑥ on the screen of the instrument panel displays the relative distance to be covered. The greater the distance, the fuller the progress bar. When driving forward, the content of the progress bar decreases upwards, and when reversing, it decreases downwards.

#### Note

If the manoeuvre is terminated prematurely during parking, the result may not be the best.

### Leaving a parking space with the parking assist system (only for parallel parking)

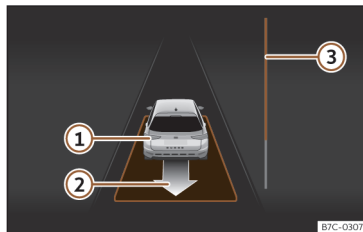

**Fig. 175** On the instrument panel display: exit a parallel parking space.

- ① Your vehicle in reverse gear
- ② Message giving the proposed manoeuvre to exit the parking space
- ③ Progress bar to indicate the distance left to cover

### Leaving a parking space (parallel parking)

The necessary conditions to exit a parking space with Park Assist have to be met >>> page 255.

- Press the P@ button >>> Fig. 170. A control lamp on the P@ button lights up when the system is switched on.
- Turn on the corresponding turn signal towards the road you will enter when exiting the parking space.
- Select reverse gear.
- Release the steering wheel >>> Δ in Introduction on page 253. Please note the following message: **Automatic steering enabled Pay attention to your surroundings.** While you keep watch around you, carefully start accelerating up to no more than 7 km/h (4 mph). When exiting the parking space, the system **only** takes charge of the steering. **You, as the driver, have to accelerate, engage the clutch if necessary, change gears and brake.**
- Reverse until the continuous ParkPilot signal sounds; **OR:** reverse until the instrument panel display shows the forward indication.

The progress bar »» Fig. 175 ③ indicates the distance to cover »» page 258 .

- Press the brake pedal until the parking assist system completes the steering wheel turns; **OR**: press the brake pedal until the symbol ③ goes out on the instrument cluster screen.
- Move forward until the continuous ParkPilot signal sounds; **OR**: move forward until the reverse indication appears on the instrument panel display. The Park Assist system steers the vehicle forward and back until it can exit the space.
- The vehicle can exit the space when a corresponding message is displayed on the instrument panel and, in some cases, an acoustic signal sounds. Take charge of the steering with the turning angle set by the Park Assist system.
- Paying attention to the traffic, exit the parking space.

### Automatic operation of the brakes by the parking assist system

Park Assist helps the driver by automatically braking in certain situations.

The driver is always responsible for braking in time »» ⚠.

### Automatic braking intervention to avoid exceeding the speed limit

To avoid exceeding the allowed speed of approx. 7 km/h (4 mph) when entering or leaving a parking space, the brakes may activate automatically. After automatically activating the brakes, the manoeuvres to enter or exit a parking space may continue.

The brakes are only automatically activated once for each attempt to enter or exit a parking space. If the speed of approximately 7 km/h (4 mph) is exceeded again, the corresponding operation is halted.

### Automatic braking to reduce damages

Depending on certain conditions, the Park Assist system can automatically brake the vehicle when faced with an obstacle, briefly acting and holding down the brake pedal »» ⚠. Following this the driver must press the brake pedal.

Automatic braking intervention to reduce damage leads to the parking manoeuvre finishing.

#### ⚠ WARNING

The automatic braking intervention by Park Assist should never tempt you to take any risk that may compromise safety. The system is not a replacement for driver awareness.

- The Park Assist system is subject to certain limitations inherent to the system. In certain situations, the automatic braking intervention may only work in a limited way or not work at all.
- Always be ready to use the brakes yourself!
- The automatic braking intervention will end after approximately 1.5 seconds. Afterwards, brake the vehicle yourself.

## Parking aid parking and manoeuvring (ParkPilot)

### Introduction

These assist systems help you when parking and manoeuvring:

- **Plus Parking Aid** »» page 261 . It is an assistant that gives a visual and audio warning of obstacles detected in *front* and *behind* the vehicle »» page 261 .
- **Rear Parking Aid** »» page 264 . An audio and visual assistant that warns of obstacles located *behind* the vehicle »» page 264 .

#### ⚠ WARNING

- Always pay attention, by looking directly, to traffic and the area around the vehicle. Assistance systems are not a replacement »»

for driver awareness. Responsibility always lies with the driver.

- The sensors have blind spots in which obstacles and people are not detected. Pay special attention to children and animals.
- Always keep visual control of the surroundings: use the mirrors for additional help.

### ⓘ CAUTION

Parking distance warning system functions can be affected by different factors that can cause damage:

- Under certain circumstances, the system does not detect or display certain objects:
  - Chains, trailer draw bars, bars, fences, posts and thin trees.
  - Objects that are located above the sensors, such as protrusions in a wall.
  - Objects with certain surfaces or structures, such as wire mesh fences or powder snow.
- Certain surfaces of objects and garments do not reflect the ultrasound sensors' signals. The system cannot detect these objects or people wearing such clothes correctly.
- Sensor signals may be affected by external sound sources. This may prevent them from detecting people or objects.
- If the system warns you of the proximity of a low obstacle, please note that after be-

ing detected by the system, the obstacle in question may disappear from the measurement sensors as the vehicle moves closer, and the system will no longer warn of its presence. In certain circumstances, objects such as high kerbs that could damage the underside of the vehicle are not detected.

- If the parking distance warning system is ignored, the vehicle could suffer considerable damage.
- Damage to the radiator grille, bumper, wheel arch and vehicle underbody can modify the orientation of the sensors. This can affect the parking aid function. Have the function checked by a specialised workshop.
- A number plate or number plate holder with dimensions that exceed the space for the number plate, or a cured or deformed number plate can cause false detections or a loss of visibility for the sensors.

### ⓘ Note

- The display on the Infotainment system screen shows a slight time delay.
- In certain situations, the system can give a warning even though there is no obstacle in the detected area:
  - Rough or cobbled surfaces or surfaces with long grass.
  - External ultrasound sources, such as other vehicles equipped with ultrasound systems.

– Heavy rain or snow, hail or dense exhaust gases.

– If the number plate is not properly secured to the surface of the bumper.

– Gradient changes.

- In order to guarantee good operation, keep the sensors clean, free of snow and ice, and do not cover them with stickers or other objects.
- If you use high-pressure or vapour equipment for cleaning, do not apply it directly, unless you do so very briefly, and always keep a distance of more than 10 cm away.
- Fitting certain accessories to the front of the vehicle, such as a plate holder with advertising, may interfere with the operation of the Park Assist.
- We recommend that you practice parking in an area without traffic.
- The volume and tone of the signals and indications can be changed»» page 265 .
- Please observe information on towing a trailer»» page 265 .

## Parking System Plus

### Description

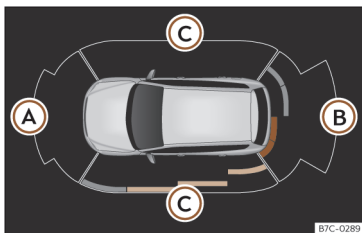

**Fig. 176** Parking aid view on the Infotainment system display.

**Parking aid plus** assists the driver by giving visual and audio warnings about obstacles detected in front of and behind the vehicle.

The bumpers are fitted with sensors. When an obstacle is detected, it is indicated by audible signals and in the Infotainment system »» **Fig. 176**.

When moving close to an obstacle, it is possible to know if the obstacle is in front of the vehicle or behind it by choosing different sounds.

The approximate measurement range of the sensors is:

**A** 1.20 m

**B** 1.60 m

**C** 0.90 m

As you approach the obstacle, the frequency of the audible signals will increase. The signal will sound continuously at around 0.30 m: Stop!

If the separation is maintained, the warning volume is reduced after about 4 seconds.

In order to view the entire periphery of the vehicle, the vehicle must be moved a few metres forwards or backwards. Thus, the missing areas are screened and obstacles at the sides of the vehicle are displayed **C**.

### Special features of ParkPilot with Area View

In the following situations the screened area on the side of the vehicle is automatically hidden:

- When a vehicle door is opened.
- When the ASR is switched off.
- When there is ASR or ESC regulation.
- If the vehicle remains stationary for more than approximately 3 minutes.

### Parking Aid operation

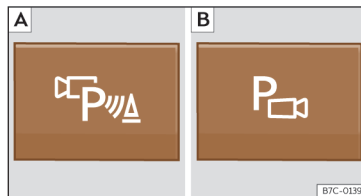

**Fig. 177** Centre console: parking aid button (depending on the version).

### Manually connecting and disconnecting the parking aid

- Press the **P** button *once*.

### Manual disconnection of Parking Aid display (the audible sounds remain active)

- Press the **BACK** ↩ function button.

### Automatic connection of Parking Aid

- Select reverse gear.
- **OR:** If you drive forward at a speed of less than 15 km/h (9 mph) and an obstacle is encountered, it is detected when it is approx. less than 95 cm. away. If the automatic connection is activated, a reduced view is shown.
- **OR:** if the vehicle moves backwards. »»

### Automatic disconnection of Parking Aid

- Drive forward at 15 km/h (9 mph) or faster.
- **OR:** move the selector lever to position **P**.

### Temporary suppression of sound in Parking Aid

- Press the  function button.

### Change from reduced view to full view

- Select reverse gear.
- **OR:** press the car icon on the reduced view.

### Switch to the reverse assist image (Rear View Camera "RVC")

- Select reverse gear.
- **OR** press the RVC function button.

A short confirmation signal will be heard and the button symbol will light up when the system is switched on.

### Automatic activation

When the **Plus Parking Aid** connects automatically, a diagram of the vehicle and the segments will appear on screen.

It only operates every time the speed is reduced below 15 km/h (9 mph) for the first time.

If it is switched off using the **PWA** button, one of the following actions must be taken for it to reactivate automatically:

- Switch off the ignition and switch it on again.
- **OR:** drive forward at over 15 km/h (9 mph) approx.
- **OR:** move the lever into position **P** and park again.
- **OR:** switch the automatic activation on and off in the Infotainment system.

The automatic activation of the parking aid can be switched on and off in the Infotainment system»» page 82»» page 86 :

- Switch the ignition on.
- Select: infotainment button  **Settings** > **Parking and manoeuvring**.
- Select **Automatic activation**. If the box is checked, the function is connected.

If activated automatically, an audible sound warning will only be given when obstacles in front are at a distance of less than 50 cm. approx.

#### CAUTION

**The automatic connection of the Parking Aid only works when you are driving slowly. If driving style is not adapted to the circum-**

**stances, an accident and serious injury or damage may be caused.**

### Visual indication segments

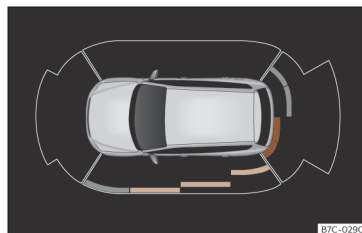

**Fig. 178** Parking aid view on the Infotainment system display.

The optical indication of the segments works as follows:

- **White and grey:** the obstacle is more than approx. 30 cm away from the path or in the direction opposite to travel. They are also displayed when the electronic parking brake is activated.
- **Yellow segments:** the obstacles lie on the vehicle's path and are at a distance of less than approx. 30 cm away.
- **Red segments:** obstacles are less than approx. 30 cm away.



A wake will indicate the anticipated forward or backward trajectory, depending on the engaged gear.

If an obstacle is located in the vehicle's way, the corresponding audible warning will sound.

When the penultimate segment is displayed, the vehicle has reached the collision zone. In the collision zone, the obstacles are represented in red (including those out of the path). Stop the vehicle! »» » ⚠ in Introduction on page 259, »» » 🚫 in Introduction on page 260!

In the event the car is equipped with the Top View Camera system, Park Assist visual guidance will appear in accordance with the view selected in the Top View Camera system.

### Setting the indications and audio signals

The displays and audio signal settings are set in the infotainment system »» » page 82.

Setup	
Automatic activation	On/off
Front volume	Volume in the front and rear area.
Rear volume	Volume in the rear area.

Setup	
Adjust volume	When the parking aid is switched on, the volume of the audio source will be reduced, depending on the selected option.
Front sound settings/sharpness	Sound tone in the front area.
Rear sound settings/sharpness	Sound tone in the rear area.

### Error messages

If an error or fault message appears on the instrument cluster in Park Assist, there is a fault.

If the fault doesn't disappear before disconnecting the ignition, it will not be indicated next time the parking aid is connected.

If a rear sensor is faulty, only the obstacles in area **(A)** are displayed »» » Fig. 176. If a front sensor is faulty, only the obstacles in area **(B)** are displayed. Symbol **(A)** is displayed.

We recommend taking the vehicle to a specialised workshop to have the fault repaired.

### Trailer mode

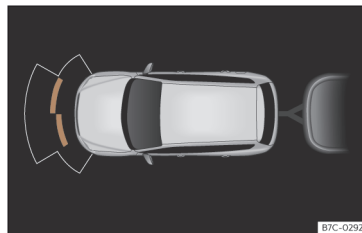

Fig. 179 Parking assist display on the screen with trailer attached.

On vehicles with a factory-fitted trailer hitch, when the trailer is connected, the rear sensors will not activate when reverse gear is engaged or button **P<sub>R</sub>** is pressed. Therefore, any objects behind or to the side of the vehicle will not be indicated on the screen and no audio signals will sound.

The screen will only display objects detected at the front, and the vehicle's trajectory will be hidden.

### Manoeuvre braking function

The emergency braking function is used to minimise damage in the event of a collision.

Depending on the equipment, if the Parking Aid is active, the braking while manoeuvring »»

function activates emergency braking when it detects an obstacle in the vehicle's path that could cause a collision, driving forwards or in reverse.

The function will not brake if the Parking Aid is activated automatically. For the system to operate, manoeuvring speed must be between 2.5-10 km/h (1.5-6 mph) for the front area and between 1.5-10 km/h (1-6 mph) for the rear.

Following an intervention, the braking while manoeuvring function will be inactive in the same direction of travel for 5 metres. Once the gear is changed, or the selector lever's position is changed, the function will be active again. The Parking Aid's limitations apply.

The braking while manoeuvring function is set in the Infotainment system: function button  > **Settings** > **Parking and manoeuvring**.

- **on** – permits the use of the braking while manoeuvring function.
- **off** – does not permit the use of the braking while manoeuvring function.

#### Temporary suppression of emergency braking

- When the function is deactivated with the **Braking while manoeuvring** button that ap-

pears on the **Parking aid** screen of the Infotainment system.

- Whenever any of the car doors, rear lid or bonnet are opened.

## Rear parking aid

### Description

The **rear parking aid** is an optical and audible assistant that warns of obstacles located *behind* the vehicle.

There are sensors integrated in the rear bumper. When they detect an obstacle, you are alerted by audible and visible warnings on the Infotainment system.



If the Top View Camera is installed, the rear parking aid will issue an audible warning about objects near the rear of the vehicle, and the Top View Camera image will be available on the infotainment screen, giving a real image of the objects around the car.

Make particularly sure that the sensors are not covered by adhesives, residues, dirt and the like, as this could affect the system's operation. Cleaning instructions >>> page 318.

The approximate measurement range of the rear sensors is:

- Side area: 0.60 m

- Central area: 1.60 m

As you approach the obstacle, the frequency of the audible signals will increase. The signal will sound continuously at around 0.30 m: Stop! >>>  in Introduction on page 259, >>>  in Introduction on page 260!

If the separation is maintained, the warning volume is reduced after about 4 seconds.

### Parking Aid operation

#### Parking Aid connection

- Select reverse gear.

#### Parking Aid disconnection

- Position the selector lever in **P**, **N** or **D**.

Set the lever to the **N** or **D** position to maintain the system active for approximately 8 seconds before switching off. During that time, Parking assist will switch off if:

- The selector lever is moved to position **P**.
- **OR**: the vehicle accelerates to approx. 15 km/h (9 mph) or faster.

If the Top View Camera is installed, rear parking aid will be automatically deactivated when disengaging reverse gear.

### Manual disconnection of Parking Aid display (the audible sounds remain active)

- Press a button on the main menu of the factory-assembled infotainment system.
- **OR** press the **BACK** ↩ function button.

### Temporary suppression of sound in Parking Aid

- Press the **🔇** function button. If you have the Top View Camera system installed, you cannot use the temporary suppression of sound in Parking Aid.

### Change from reduced view to full view

- Select reverse gear.
- **OR:** on vehicles fitted with reverse assist (Rear View Camera "RVC") click on the car icon of the reduced display.

### Switch to the reverse assist image (Rear View Camera "RVC")

- Select reverse gear.
- **OR:** press the **RVC** function button.

### Setting the indications and audio signals

The indications and audio signal settings are in the infotainment system»»» page 82.

- **Rear volume:** volume in the rear area.
- **Rear sound settings/treble:** sound tone in the rear area.

- **Lower volume:** when the parking aid is switched on, the volume of the audio source will be reduced, depending on the selected option.

### Error messages

If an error or fault message appears on the instrument cluster in Park Assist, there is a fault.

If the fault doesn't disappear before disconnecting the ignition, it will not be indicated next time the parking aid is connected.

If there is a fault in a sensor, the **⚠** symbol is displayed on the infotainment system display.

We recommend taking the vehicle to a specialised workshop to have the fault repaired.

### Towing device

In vehicles equipped with a towing bracket device from the factory, when the trailer is connected, the parking aid will not be activated when reverse gear is engaged.

## Visual indication segments

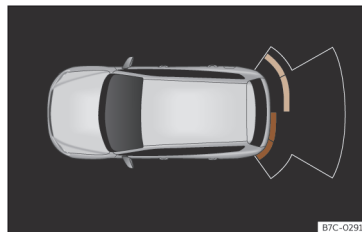

**Fig. 180** Parking aid view on the Infotainment system display.



The distance to the obstacles can be estimated with the help of the segments at the rear of the vehicle.

The optical indication of the segments works as follows:

- **White segments:** the obstacle is more than approx. 30 cm away from the path or in the direction opposite to travel. They are also displayed when the electronic parking brake is activated.
- **Yellow segments:** the obstacles lie on the vehicle's path and are at a distance of less than approx. 30 cm away.
- **Red segments:** obstacles are less than approx. 30 cm away.



Whenever the obstacle is located in the vehicle's direction of travel, the corresponding audible warning will sound.

As the vehicle approaches an obstacle, the segments are displayed closer to the vehicle. When the penultimate segment is displayed, this means that the vehicle has reached the collision zone. In the collision zone, the obstacles are represented in red (including those out of the path). Do not continue to reverse >>>  in Introduction on page 259, >>>  in Introduction on page 260!

#### If equipped with the Top View Camera

Segments are not displayed when the vehicle is equipped with a Top View Camera.

The Parking Aid system will issue an audible warning for objects that are near the rear of the vehicle, and the Top View Camera image will be available on the screen, giving a real image of the objects around the car.

## Trailer Assist

### Introduction

Trailer assist helps the driver to reverse and manoeuvre with a trailer.

By moving the rotary knob of the exterior mirrors, the trailer assist directs the trailer

that is hitched. The driver has to accelerate, change gears and brake!

#### System limitations

Under certain circumstances, the camera does not detect objects such as trailer draw bars, bars, fences, posts or thin trees, or an open (or opening) rear lid, which could damage the vehicle.

In order to guarantee good system operation, keep the camera clean, free of snow or ice, and do not cover it with adhesives or other objects. Do not allow the draw bar to be covered by external influences.

Use the trailer manoeuvre assistant only when the rear lid is closed correctly.

#### CAUTION

**The trailer maneuver assistant does not take the vehicle's surrounding as a reference. No obstacle detection takes place. The driver alone has to assess whether it is possible to manoeuvre safely with the tow vehicle and trailer set.**

- Always observe the movement of the trailer and, if necessary, actively interrupt the manoeuvre to avoid damage. Even if the trailer manoeuvring assistant is operated correctly, on rare occasions the trailer may move in a different way to the setting.
- Do not rely solely on the indications on the instrument cluster display.

#### Note

**The trailer manoeuvre assistant automatically switches off approx. 10 minutes after being activated. The assistant is also deactivated if the driver does not perform any action over the course of approx. 3 minutes.**

### Requirements

The following requirements must be met for the trailer manoeuvre assistant to work:

- The engine is running.
- The ESC must be connected.
- The driver's door and the rear lid are closed.
- The exterior mirrors are not folded.
- There is a non-articulated one or two axle trailer hitched and electrically connected.
- Both the tow vehicle and trailer are stopped.
- The maximum bending angle has not been exceeded.
- The length of the trailer's drawbar has been determined.

### Determine the length of the trailer's drawbar

In order for the trailer manoeuvre assistant to determine the length of the trailer's drawbar, drive the vehicle-trailer set through some turning manoeuvres or curves. The more precisely the length of the drawbar is determined, the wider the angles that will be available when manoeuvring. The assistant subdivides the maximum available end stops of the angle indicator into four levels: approx. 30°, 45°, 60° and 75°.

#### Note

For technical reasons, the trailer manoeuvre assistant cannot always correctly detect trailers with LED technology taillights.

### Operating

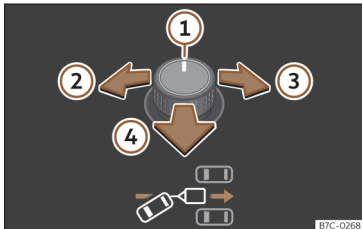

**Fig. 181** Rotary exterior mirror controls: adjust the trailer angle.

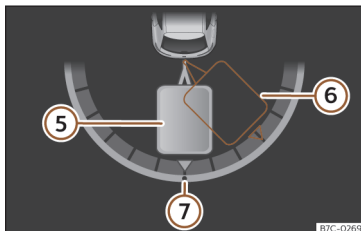

**Fig. 182** Instrument panel display: engage reverse gear

Key of the **Fig. 181**, **Fig. 182** :

- ① Rotary exterior mirror controls.
- ② Trailer orientation to the left
- ③ Trailer orientation to the right
- ④ Move the vehicle in the direction of the towing device.
- ⑤ Actual trailer position
- ⑥ Target trailer position
- ⑦ Angle indicator zero position

### Manoeuvre with the tow vehicle and trailer set

The system requirements must be met  
»» page 266.

- Select reverse gear.
- Press button **P**.
- Release the steering wheel »» **Δ**.

• Tilt the rotary control until the desired direction is reached »» **Fig. 181**. A representation of the tow vehicle and trailer set is shown on the instrument cluster screen for guidance purposes »» **Fig. 182**.

- Reverse by accelerating slowly. Pay attention to your surroundings!
- If necessary, correct the angle with the rotary control. Press the control towards the left or right: the set will move to the left or right. Press the control backwards: the vehicle will follow the trailer.
- Reverse and move forwards until the desired position is reached.
- The manoeuvre ends when a message is displayed on the instrument cluster display and, in some cases, an audio signal sounds.

### Automatic brake operation

The trailer manoeuvre assistant helps the driver by automatically operating the brakes in certain situations.

The driver is responsible for braking in time »» **Δ**.

The brakes may be applied automatically and the function deactivated in the following situations:

- A certain speed is exceeded.
- The steering wheel is grabbed. The vehicle brakes automatically until it stops. »»

- If the key  is pressed during the manoeuvre or the driver's door opens.

### WARNING

The quickly turning steering wheel can cause serious injuries.

- Do not hold the steering wheel during the manoeuvre until the system requests it.
- Exception: If a dangerous situation occurs, intervene and take over the steering.

### WARNING

Never allow the automatic operation of brakes to lead you to take any risk that compromises safety. The system is not a replacement for driver awareness.

- The manoeuvre assist system is subject to certain limitations inherent to the system. In certain situations, the automatic braking intervention may only work in a limited way or not work at all.
- Always be ready to use the brakes yourself!
- Automatic brake operation ends after 1.5 seconds approx. if the vehicle is stopped. After this, brake the vehicle yourself.

### Note

The exterior mirrors cannot be adjusted while the assistant is active. The saved setting for the passenger's mirror can be activated»» page 121.

## Problems and solutions

### Camera with no visibility, fault message, the system disconnects

- Clean the camera or remove possible adhesives or accessories from it»» page 319.
- Check for visible damage.

### The system behaves differently than expected

There can be several causes:

- The camera is dirty»» page 319. In addition to dirt and snow, camera visibility can be reduced by detergent residue or any type of coating.
- The system requirements must be met »» page 266.
- The camera is covered with water.
- The vehicle has some type of damage in the camera area, e.g. due to a parking impact.
- The field of view of the camera is blocked by an accessory, e.g. a bicycle carrier system.
- Changes have been made to the paint in the camera area and structural modifications have been made, e.g. to the front part of the vehicle and the running gear.

### Solution for all cases

- Temporarily disconnect the system.

- Check if one of the causes indicated above has occurred.
- Once the source of the problem has been eliminated, the system may be reconnected.
- If the system still behaves unpredictably, have it checked by a specialised workshop.

## Peripheral view system (Top View Camera)

### Introduction

Using 4 cameras, the system generates a representation that is shown on the infotainment system display. The cameras are located on the radiator grille, the exterior mirrors and the rear lid.

The functions and representations of the Area View system may vary depending on whether or not the vehicle has ParkPilot.

### WARNING

The image from the cameras does not make it possible to calculate the distance to the obstacles (people, vehicles, etc.) precisely, so using them could cause serious accidents and injury.

- The camera lenses augment and distort the visual field and the objects on the screen are seen differently and imprecisely.

- Certain objects may not be shown or may not be shown very clearly, for example, posts or thin rails, due to the screen resolution or if light conditions are insufficient.
- The cameras have blind spots in which obstacles and people are not registered.

### **⚠ WARNING**

The smart technology incorporated into the Top View Camera system cannot overcome the limits imposed by the laws of physics and it only works within the limits of the system. The greater convenience provided by the Area View system should never tempt you to take any risk that may compromise safety. If used negligently or involuntarily, it may cause serious accidents and injuries. The system is not a replacement for driver awareness.

- Adapt your speed and driving style to suit visibility, weather, road and traffic conditions.
- Do not be distracted from the traffic by looking at the screen.
- Monitor the area around the vehicle at all times, since the cameras do not capture small children, animals and certain objects in all situations.
- The system will probably be unable to represent all areas clearly.

### **⚠ CAUTION**

- The camera images are only two-dimensional. Due to a lack of spatial depth, objects that jut out or holes on the road, for example, are more difficult to detect or may not be seen at all.
- In certain circumstances, the camera does not capture objects such as beams, fences, posts or thin trees, which could damage the vehicle.
- The system displays the auxiliary lines and boxes regardless of the vehicle's environment, no objects are detected. The driver is responsible for determining that the vehicle will fit in the parking space.

### Area View system

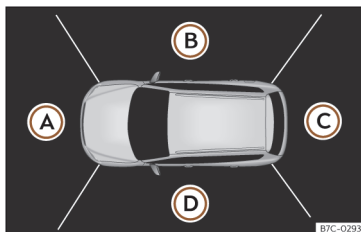

**Fig. 183** Viewing the top view system: aerial view.

There are four different views to choose from:

- (A)** Front camera area
- (B)** Right camera area
- (C)** Rear camera area
- (D)** Left camera area

Function buttons **Fig. 183**:

- ✕** Exit the current display.
- ☼** Adjust the display: bright, contrast and colour.
- 3D** Three-dimensional views
- 🔊** Depending on the equipment: connecting and disconnecting the ParkPilot sound.

The aerial view is generated by combining the images from all the cameras **📷** **>>> Fig. 183**. The aerial view can be selected by pressing the **vehicle** in the area.

Select the corresponding view by pressing the different areas **>>> Fig. 183 (A) to (D)** of the aerial view or the reduced aerial view.

### Conditions necessary for the use of the Area View system

- The doors and the rear lid must be closed.
- The image must be reliable and clear. For this reason, for example, the camera lens must be clean.



- The area around the vehicle must be clearly and totally visible.
- The area for parking or manoeuvring should be a flat surface.
- The vehicle should **not** be loaded very heavily at the rear.
- The driver must be used to the system.
- There should be no damage to the vehicle in the camera area. If the position or installation angle of the cameras have been changed, e.g. after a rear-end collision, the system should be checked by a specialised workshop.

### Special characteristics

The images on the area view system cameras are only two-dimensional. Due to a lack of spatial depth, it is difficult or impossible to make out on-screen any holes there may be on the ground, objects jutting out from the ground or parts protruding from other vehicles.

Situations in which the objects or other vehicles appear to be further away or closer than they really are:

- On moving from a horizontal plane to a slope.
- On moving from a slope to a horizontal plane.
- If the vehicle is heavily loaded at the rear.

- If the vehicle approaches protruding objects. These objects may be outside the cameras' angle of visibility.

### Trailer mode

The Area View system conceals, in the rear camera area, all the auxiliary guiding lines when the factory-fitted towing bracket is connected electrically to a trailer  
 >>> page 274.

#### Note

**To become familiar with the system and its functions, CUPRA recommends that you practice handling the Area View system in an area where there is not too much traffic or in a car park.**

## Connecting and disconnecting

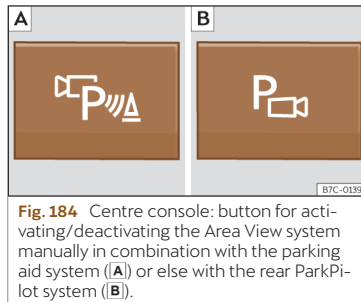

**Fig. 184** Centre console: button for activating/deactivating the Area View system manually in combination with the parking aid system (A) or else with the rear ParkPilot system (B).

### Manual activation

- Press button  once >>> **Fig. 184**.

The infotainment system screen displays the aerial view >>> **Fig. 183**. If you press the  button when driving at over 15 km/h (9 mph), the image will not be displayed.



### Automatic activation

- Select reverse gear.
- **OR:** The vehicle moves backwards.

The view of the image of the vehicle's rear camera is shown in parallel parking mode with the reduced aerial view.



### Manual disconnection

- Press button  again >>> **Fig. 184**.
- **OR:** press a button on the factory-equipped infotainment system, for example the  button.
- **OR:** press the X function button.



### Automatic off

- Drive forwards at over 15 km/h (9 mph) approximately.
- **OR:** switch off the ignition. The Area View system menu disappears immediately.

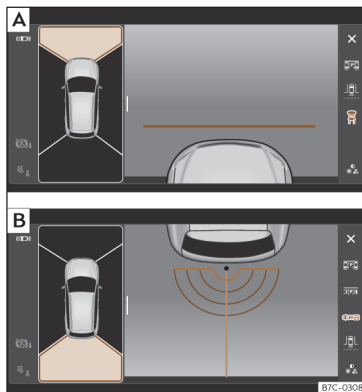
### Views of the peripheral vision system (modes)



**Fig. 185** Display on the top view system screen: **A** Front camera: off-road view. **B** Rear camera: off-road view.

-  Depending on the equipment: connecting and disconnecting the ParkPilot sound.
-  Exiting the Area View system screen:
-  Adjust the display: bright, contrast and colour.

The selected view is displayed on the right side of the screen. The reduced aerial view

shown on the right side displays the view framed in yellow. In addition, the right margin of the screen displays the menu options possible and the views (the so-called “modes”) of the camera in question. The active view (mode) at the time is highlighted.



The red lines are indicate a distance of approx. 40 cm away from the vehicle.

### Aerial views (bird's eye view)

*Main mode:*

-  The vehicle and its immediate vicinity seen from above are shown. Depending on the equipment, the ParkPilot's path may also be displayed.

*Three-dimensional views:*

-  The vehicle and its vicinity seen from above are shown.
-  The vehicle and its vicinity seen from above are shown obliquely.
-  The vehicle and its vicinity seen obliquely are shown.

Swipe the infotainment system display with your finger in the direction of the arrows to change the angle of vision in the three-dimensional views of the vehicle and its vicinity. »

### Front camera views (front view)

 Cross traffic. This visualization helps to monitor traffic to the left, front and right of the vehicle and can be used, for example, when exiting garages or narrow exits.

 Angle parking. The area in front of the vehicle is shown. Orientation lines are shown to give guidance.

 Off-road. The area directly in front of the vehicle seen from above is shown. For example, on a slope, in order to see the area directly in front of the vehicle.

### Side camera views (side view)

 Right and left sides. The areas located directly to the side of the vehicle seen from above are represented in order to navigate possible obstacles more precisely.

 The driver's or passenger's side seen from above is shown. This makes it possible to visualize the blind spots along the vehicle.

### Rear camera views (rear view)

 Angle parking. The area behind the vehicle is shown. Auxiliary lines are shown to give guidance.

 Parallel parking. The area directly behind the vehicle is shown. The col-

oured boxes and auxiliary lines serve as orientation.

 Off-road or hitching a trailer function. The vehicle's rear is presented.

Green and red semicircular auxiliary lines are displayed in vehicles with a factory-fitted towing bracket. The auxiliary lines indicate the distance from the towing bracket. The distance between the auxiliary lines (green and red) is approx. 30 cm The orange auxiliary line indicates, according to how the steering wheel is turned, the precalculated direction of the towed device.

 Cross traffic. This visualization helps to monitor traffic to the left, front and right of the vehicle and can be used, for example, when exiting garages or narrow exits.

## Reverse Assist (Rear View Camera)

### Operating and safety warnings

#### WARNING

- The reverse assist does not make it possible to precisely calculate the distance from obstacles and nor can it overcome the system's own limits, hence its negligent use

may cause serious accidents and injuries if used without due care. The driver should be aware of his/her surroundings at all times to ensure safe driving.

- The camera lens expands and distorts the field of view and displays the objects on the screen in a way that is different from reality. Distance perception is also distorted.
- Due to the screen resolution or light conditions, some items may be blurry or not displayed at all. Take care with thin posts, fences, railings or trees that might not be seen on the screen and could damage the vehicle.
- The reverse assist has blind spots where it cannot see people or objects. Monitor the vehicle's surrounding area at all times.
- Keep the camera lens clean, free of ice and snow, and do not cover it.
- The system is not a replacement for driver awareness. Supervise the parking manoeuvre and the vehicle's surrounding area at all times.
- Do not be distracted from the traffic by looking at the screen.
- The images are only two-dimensional. Protruding objects or holes in the road, for example, are more difficult to detect or may not be seen at all.
- Vehicle load modifies the representation of the guide lines»» Fig. 186 . The width

represented by the lines decreases with vehicle load. Pay special attention to the surroundings when the inside of the vehicle or the luggage compartment are loaded.

- In the following situations, objects or other vehicles appear to be further away or closer than they actually are. Pay special attention:
  - If moving from a flat surface to a slope and vice-versa.
  - If the vehicle is heavily loaded.
  - When the vehicle approaches objects that are not on the ground surface or that protrude from it. These objects may be outside the camera angle when reversing.

### Note

- It is important to take great care and pay special attention if the driver is not familiar with the system.
- Reverse assist will not be available if the rear lid is open.

### Usage instructions

A camera installed in the rear lid handle assists the driver with reverse parking or manoeuvring» page 219.

The camera image is viewed together with orientation lines projected on the Infotain-

ment system screen. Part of the bumper can be seen at the bottom, which can be used by the driver as a reference point.

### Rear assist settings

Rear assist offers the user the possibility to change the image's *brightness*, *contrast* and *colour* settings.

To change these settings:

- Stop the vehicle in a safe place without switching off the ignition or the infotainment system.
- Apply the parking brake.
- Select reverse gear.
- Press the  function button displayed on the screen.
- Make the desired adjustments on the menu by pressing the  $-/+$  function buttons or by moving the scroll button.

### Requirements for parking and manoeuvring with the rear assist

The system should not be used in the following cases:

- If the image displayed is not very reliable or is distorted, or if the lens is dirty.
- If the area behind the vehicle is incomplete.
- If the vehicle is heavily loaded.

- If the position of the camera has changed after a rear-end collision. Have the system checked by a specialised workshop.

### Familiarising yourself with the system

To familiarise yourself with the system, the orientation lines and their function, CUPRA recommends practising in a place without too much traffic or in a car park when there are good weather and visibility conditions.

### Parking and manoeuvring with reverse assist

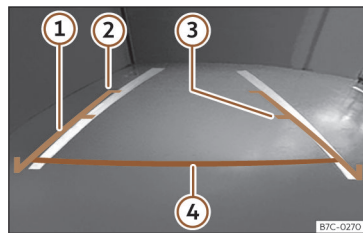

**Fig. 186** On the Infotainment system screen.: guide lines.

### Meaning of the orientation lines

»» **Fig. 186**

- ① **Lateral lines:** extension of the vehicle (approximately in its total width) on the road.



- ② **End of the side lines:** approx. 2 m behind the vehicle on the road.
- ③ **Intermediate line:** approx. 1 m behind the vehicle on the road.
- ④ **Horizontal red line:** a safe distance of approx. 40 cm at the rear of the vehicle on the road.

#### Switching the system on and off

- Reverse assist is connected by a contact when engaging reverse gear.
- The system switches off 8 seconds after disengaging reverse gear and immediately after removing the contact.
- The camera will stop transmitting images above the speed of 15 km/h (9 mph) with reverse engaged.

In combination with the parking aid plus system»» page 261, the camera image will no longer be displayed when reverse gear is disengaged, and the system will display the optical information provided by the parking aid system.

It is also possible to hide the reverse assist image:

- By pressing one of the Infotainment system buttons on the display.

- **OR:** by clicking on the miniature vehicle shown on the screen.

If you wish to display the rear assist image again:

- Disengage and re-engage reverse gear.
- **OR:** Press the **RVC** function button<sup>1)</sup>

#### Parking manoeuvre

- Stop the vehicle in front of a space and select reverse gear.
- Reverse slowly, and turn the steering wheel so that the side lines lead towards the parking space.
- Guide the vehicle into the parking space so that the side lines run parallel to it.

## Towing bracket device

### Trailer mode

#### Introduction

Take into account country-specific regulations about driving with a trailer and the use of a towing bracket.

The vehicle has been developed primarily for carrying people, although it can also be used to tow a trailer if fitted with the corresponding technical equipment. This additional load has an effect on the useful life, fuel consumption and vehicle performance and in some cases can reduce the service intervals.

Driving with a trailer requires more force from the vehicle, and thus more concentration from the driver.

In winter, winter tyres should be fitted on both the vehicle **and** the trailer.

#### Maximum vertical load technically permitted on the coupling device

The *maximum* vertical load technically permitted from the trailer draw bar on the towing bracket's tow ball is **90 kg**.

<sup>1)</sup> The RVC button will only be displayed when reverse gear is engaged.

### Vehicles with the Start-Stop system

If the vehicle has a factory-fitted towing bracket or one that is retrofitted by CUPRA, the Start-Stop system operates as normal. No special characteristics need to be taken into account.

If the system does not recognise the trailer or the trailer bracket has not been retrofitted by CUPRA, the Start-Stop system must be disconnected by pressing the corresponding button in the lower part of the centre console before driving with the trailer, and it should remain off for the rest of the journey »»» ⚠.

### Vehicles with driving profile selection

If you are going to be towing a trailer, the use of the **Eco** driving profile is not recommended. You are advised to select another of the available driving profiles before beginning to drive with a trailer.

### Trailer weight/drawbar load

Never exceed the authorised trailer weight. If you do not load the trailer up to the maximum permitted trailer weight, you can then climb correspondingly steeper slopes.

The maximum trailer weights listed are only applicable for **altitudes** up to 1000 m above sea level. Since higher altitude decreases engine performance and the ability to climb slopes, the tow load decreases proportional-

ly. The weight of the vehicle and trailer combination must be reduced by 10% for every 1000 m of altitude. When possible, operate the trailer with the maximum **authorised drawbar load** on the ball joint of the towing bracket, but **do not exceed** the specified limit.

#### ⚠ WARNING

Never use the trailer to transport people, since it would put their life in danger and is also prohibited.

#### ⚠ WARNING

Undue use of the towing bracket may cause injury and accidents.

- Only use the towing bracket if it is in a perfect state of repair and is properly secured.
- Never modify or repair the towing bracket in any way.
- In order to reduce the danger of injury in the event of rear-end collisions and to avoid injury to pedestrians and cyclists when parking the vehicle, cover or remove the tow hook when you are not using a trailer.
- Never fit a towing bracket “with weight distribution” or “load compensation”. The vehicle has not been designed for this type of towing bracket. The towing bracket could fail and the trailer could be released from the vehicle.

#### ⚠ WARNING

Driving with a trailer and transporting heavy or large objects can affect driving properties and even cause an accident.

- Always secure the load properly using belts or straps that are suitable and in good condition.
- Adapt your speed and driving style at all times to suit visibility, weather, road and traffic conditions.
- Trailers with a high centre of gravity are more likely to overturn than those with a low one.
- Avoid sudden braking and manoeuvres.
- Take great care when overtaking.
- Reduce speed immediately if you notice that the trailer is swaying, however slightly.
- Never drive at more than 80 km/h (50 mph) when towing a trailer (or at more than 100 km/h (60 mph) in exceptional circumstances). This also applies in countries where driving at higher speeds is permitted. Take into account the speed limit for vehicles with trailers in the corresponding country, as it could be less than the speed limit for vehicles without a trailer.
- Never attempt to “straighten” the towing vehicle and trailer while accelerating.

#### ⚠ WARNING

If the towing bracket has been retrofitted by a non-CUPRA workshop, the Start-Stop »

system must be disconnected manually whenever driving with a trailer. Otherwise the brake system could be damaged and could consequently cause a serious accident or injury.

- Always disconnect the Start-Stop system manually when using a towing bracket that has not been fitted by a CUPRA workshop.

#### **i** Note

- Before hitching or unhitching a trailer, always deactivate the anti-theft alarm >>> page 90. Otherwise, the tilt sensor could cause the alarm to go off.
- Do not drive with a trailer for the engine's first 1000 km >>> page 212.
- CUPRA recommends that, if possible, the tow hook be removed or covered when it is not going to be used. In the event of a rear-end collision, the damage to the vehicle could be greater if the tow hook is fitted.
- Some retrofitted towing brackets cover the rear towing eye. In these cases, the towing eye should not be used for tow-starting or for towing other vehicles. For this reason, if the vehicle has been retrofitted with a towing bracket, always keep the tow hook in the vehicle when you remove it.

## Technical requirements

Vehicles that are **factory-mounted** with a towing device meet all the technical and legal requirements for driving with a trailer >>> page 281.

If the **vehicle is retrofitted** with a towing bracket, only a bracket that is authorised for the maximum authorised load of the trailer that is to be towed may be fitted. The towing bracket must be suitable for the vehicle and the trailer and must be properly secured to the vehicle's chassis. Only use a towing bracket that has been authorised by CUPRA for this vehicle. Always check and take into account the towing bracket manufacturer's instructions.

### Towing bracket fitted on the bumper

Never fit a towing bracket to the bumper or to the area where the bumper is mounted. The towing bracket should not impair the bumper's function. Do not make modifications or repairs to the exhaust system or the brake system. Make regular checks to ensure that the towing bracket is secure.

### Engine cooling system

Driving with a trailer increases the load on the engine and cooling system. The cooling system should have sufficient coolant and be prepared for the additional effort involved in driving with a trailer.

### Trailer brakes

If the trailer has its own brake system, please take the relevant legal requirements into account. Never connect the trailer's brake system to the vehicle's brake system.

### Tow cable

Always use a cable between the vehicle and the trailer >>> page 277.

### Trailer tail lights

The trailer's rear lights should comply with the statutory safety regulations >>> page 277.

Never connect the trailer's rear lights directly to the vehicle's electric system. If you are not sure that the trailer's electrical connection is correct, have it checked by a specialised workshop. To do so, CUPRA recommends going to a specialised CUPRA dealer or any SEAT dealership.

### Exterior mirrors

If you cannot see the area behind the trailer with the exterior mirrors of the towing vehicle, additional mirrors will have to be installed in accordance with the regulations of the country in question. The exterior mirrors should be adjusted before you start driving and must provide a sufficient field of vision at the rear.

## Towing bracket device

### Trailer maximum electricity consumption

Never exceed the values indicated!

#### Europe, Asia, Africa, South America and Central America

Brake lights (total)	84 Watts
Turn signal (on each side)	42 Watts
Side lights (on each side)	50 Watts
Reverse lights (in total)	42 Watts
Rear fog light	42 Watts

#### Australia

Brake lights (total)	108 Watts
Turn signal (on each side)	54 Watts
Side lights (on each side)	100 Watts
Reverse lights (in total)	54 Watts
Rear fog light	54 Watts

### ⚠ WARNING

If the towing bracket is wrongly fitted or is not the right one, the trailer could become detached from the vehicle and cause serious injury.

### ⚠ CAUTION

- If the rear lights of the trailer are not correctly connected, the vehicle's electronic system may be damaged.

- If the trailer absorbs excessive electric current, the vehicle's electronic system may be damaged.
- Never connect the trailer's electric system directly to the electrical connections of the tail lights or any other power sources. Only use the connections intended for providing electric current to the trailer.

### Hitching and connecting a trailer

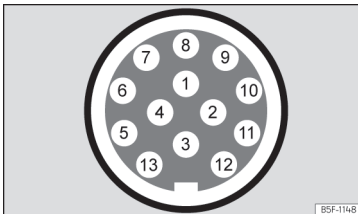

**Fig. 187** Schematic representation: assignment of the pins of the trailer's electrical socket.

Pin	Meaning
1	Left turn signal
2	Rear fog light
3	Earth for pins 1, 2, 4, 5, 6, 7 and 8
4	Right turn signal

Pin	Meaning
5	Rear light, right
6	Brake lights
7	Rear light, left
8	Reverse lights
9	Permanent live
10	Live charge cable
11	Earth for pin 10
12	Unassigned
13	Earth for pin 9

### Power socket for trailer

The vehicle is fitted with a 13-pole power socket for the connection between the trailer and the vehicle. With the engine running, electrical devices on the trailer receive power from the electrical connection (pin 9 and pin 10 of the trailer power socket).

If the system detects that a trailer has been connected, the consumers on the trailer will receive electricity through this connection (pins 9 and 10). Pin 9 has a permanent live. This powers, for example, the trailer's interior lighting. Electrical devices such as a fridge in a caravan **only** receive electrical power if the engine is running (through pin 10). »

To avoid overloading the electrical system, you cannot connect the ground wires of pin 3, pin 11 or pin 13.

If the trailer has a **7-contact connector**, you will need to use an adapter cable. In this case the function corresponding to pin 10 will not be available.

### Tow cable

The tow rope must always be securely fixed to the towing vehicle and loose enough so that the vehicle can handle turns smoothly. However, make sure that the cable does not rub on the ground while driving.

### Trailer tail lights

Always check the trailer's rear lights to ensure they are working correctly and that they comply with the relevant safety regulations. Make sure that the maximum permissible power that can be absorbed by the trailer is not exceeded»» page 277.

### Include in the anti-theft alarm

The trailer is included in the anti-theft system if the following conditions are met:

- If the vehicle is factory-equipped with an anti-theft alarm and towing bracket.
- If the trailer is electrically connected to the towing vehicle through the trailer power socket.

- If the electrical systems of the vehicle and trailer are in perfect condition and have no faults or damage.
- If the vehicle is locked with the key and the anti-theft alarm is activated.

When the vehicle is locked, the alarm is triggered if the electrical connection with the trailer is cut off.

Before hitching or unhitching a trailer, always turn off the anti-theft alarm. Otherwise, the tilt sensor could cause the alarm to go off.

### Trailers with LED tail lights

For technical reasons, trailers fitted with LED rear lights cannot be connected to the anti-theft alarm system.

When the vehicle is locked, the alarm does not go off when the electrical connection with the trailer is cut if it has rear lights with light-emitting diodes.

### WARNING

If the cables are improperly or incorrectly connected, it may lead to an excessive amount of current supplied to the trailer, which can cause abnormalities in the entire vehicle electronic system, as well as accidents and serious injuries.

- Ensure that any repairs that need to be carried out on the electrical system are carried out by a specialised workshop.

- Never connect the trailer's electric system directly to the electrical connections of the tail lights or any other power sources.

### WARNING

Contact between the pins of the trailer power socket can cause short circuits, overloading of the electrical system or failure of the lighting system, and consequently can cause accidents and serious injuries.

- Never connect the pins of the trailer power socket to each other.
- Make sure any work on bent pins is carried out by a specialised workshop.

### CAUTION

Do not leave the trailer connected to the vehicle when parked; place it on its support wheel or its supports. If the vehicle rises or falls due, for example, to a variation of the load or a burst tyre, increased pressure will be placed on the towing bracket and the trailer, and both the vehicle and the trailer can be damaged.

### Note

- In case of anomalies in the electrical systems of the vehicle or trailer, as well as in the anti-theft alarm system, have them inspected by a specialised workshop.



- If the trailer accessories consume energy through the power socket to the trailer and the engine is turned off, the battery will discharge.
- If the vehicle battery is running low, the electrical connection with the trailer will be automatically cut.

### Trailer loading

#### Technically permissible maximum trailer weight and vertical load on the coupling device

The technically permissible maximum trailer weight is the weight that the vehicle can tow >>> ⚠. The vertical load on the coupling is exerted vertically from above on the hook of the towing bracket.

The information on the maximum trailer weight and vertical load on the coupling device contained in the type plate of the towing bracket are experimental values only. The correct figures for your specific model, which may be *lower* than these figures, are given in the vehicle documentation. The information in the vehicle documentation takes precedence at all times.

To promote safety while driving, CUPRA recommends making the most of the maximum **vertical load** technically permissible on the coupling device >>> page 274 . An insufficient

vertical load has a negative influence on the behaviour of both the vehicle and trailer.

The vertical load increases the weight on the rear axle, reducing the vehicle's carrying capacity.

#### Gross combination weight of the towing vehicle and trailer

The gross combination weight is the actual weight of the loaded vehicle plus the actual weight of the loaded trailer.

In some countries trailers are classified into distinct categories. CUPRA recommends obtaining information from a specialised workshop regarding which type of trailer is most suitable for your vehicle.

#### Trailer loading

The weight of the towing vehicle and trailer must be balanced. In order to do this, the load must be as close as possible to the maximum vertical load technically permissible on the coupling point, and it must be evenly distributed between the back and front of the trailer:

- Distribute loads in the trailer so that heavy objects are as near to the axle as possible or above it.
- Secure the trailer load properly.

#### Tyre pressure

Set the tyre pressure of the trailer tyres in accordance with the trailer manufacturer's recommendations.

When towing a trailer, inflate the tyres of the towing vehicle with the maximum allowable pressure >>> page 306 .

#### ⚠ WARNING

**If the maximum permissible axle weight, the maximum load technically permissible on the coupling point, the maximum authorised vehicle weight or the gross combination weight of the towing vehicle and trailer are exceeded, accidents and serious injuries may occur.**

- Never exceed the values indicated!
- The actual weight on the front and rear axles must never exceed the maximum permissible axle weight. The weight on the front and rear axles must never exceed the maximum permissible weight.

#### ⚠ WARNING

**A shift in weight could jeopardize the stability and security of the towing vehicle and trailer, which could lead to accidents and serious injuries.**

- Always load the trailer correctly.
- Always secure the load properly using belts or straps that are suitable and in good condition.

## Driving with a trailer

### Adjusting the headlights

The front part of the vehicle may be raised when the trailer is connected and the light may dazzle the rest of the traffic.

Adapt the height of the headlights using the headlight range adjuster»» page 117<sup>1)</sup>.

### Specific features of driving with a trailer



- If your trailer has an **overrun brake**, brake *gently at first* and then rapidly. This will prevent the jerking that can be caused by the locking of trailer wheels.
- Due to the gross combination weight of the towing vehicle and trailer, the braking distance increases.
- When going down a slope, go into a lower gear (in tiptronic automatic gearbox mode) to take advantage of the braking power provided by the engine. Otherwise, the braking system could overheat and even fail.
- The trailer weight, as well as the gross combination weight of the towing vehicle and trailer, change the centre of gravity and the properties of the vehicle.
- If the towing vehicle is empty and the trailer is loaded, then the load distribution is in-

correct. Under these conditions, drive slowly and with extra caution.

### Hill starts with a trailer

Depending on the slope of the hill and the combination weight of the towing vehicle and trailer, the vehicle might start rolling backwards slightly when you first start up.

For hill-starting with a trailer, do the following:

- Press and hold the brake pedal.
- Press the  button once to disconnect the electronic parking brake»» page 247.
- Move the selector lever to the **D/S** position »» page 201.
- Pull out the  button and hold it in that position to immobilise the towing vehicle and trailer with the electronic parking brake.
- Release the brake pedal.
- Start driving slowly.
- Do not release the  button until the engine has sufficient power to start driving.

### WARNING

**If a trailer is pulled incorrectly, this may lead to loss of control of the vehicle and serious injury.**

- Driving with a trailer and transporting heavy or large objects will change the vehicle handling and braking distances.
- Always drive cautiously and carefully. Brake earlier than usual.
- Adapt your speed and driving style at all times to suit visibility, weather, road and traffic conditions. Slow down, especially when driving down hills or slopes.
- Accelerate with particular care and caution. Avoid sudden braking and manoeuvres.
- Take great care when overtaking. Reduce speed immediately if you notice that the trailer is swaying, however slightly.
- Never attempt to “straighten” the towing vehicle and trailer while accelerating.
- Take into account the speed limit for vehicles with a trailer, as it could be lower than for vehicles without a trailer.



## Stabilisation of the towing vehicle and trailer combination

The stabilisation of the vehicle and trailer combination is an additional function of the electronic stability control (ESC).

<sup>1)</sup> This does not apply for vehicles with Full LED xenon headlights.

If the vehicle and trailer stabilisation system detects that the trailer is weaving, it takes action on the steering control to reduce the weaving of the trailer.

### Vehicle and trailer combination stabilisation requirements

- The vehicle is factory-equipped with a towing bracket or has been retro-fitted with a compatible towing bracket.
- The ESC and the ASR are switched on. The control lamp  or  is not lit up on the instrument cluster.
- The trailer is connected to the towing vehicle through the trailer power socket.
- The vehicle is travelling at over 60 km/h (approx. 37 mph).
- The maximum vertical load technically permissible is not being exceeded on the coupling device.
- The trailer has a rigid draw bar.
- If the trailer has brakes, it must be equipped with a mechanical overrun brake.

### WARNING

The enhanced safety provided by the electric stability control of the vehicle and trailer should not lead you to take any risks that could compromise your safety.

- Adapt your speed and driving style at all times to suit visibility, weather, road and traffic conditions.
- Accelerate with caution when the road is slippery.
- When adjusting any settings, stop accelerating.

### WARNING

The electric stability control for the vehicle and trailer may not correctly detect all driving conditions.

- When the ESC is switched off, the stabilisation of the towing vehicle and trailer is also switched off.
- The stability system does not always detect light trailers, so it may not stabilise these correctly.
- When driving on surfaces with poor grip, the trailer can even *interfere* with the stability system.
- Trailers with a high centre of gravity can tip over without having previously weaved.
- If a trailer is not attached, but a connector is plugged into the power socket (e.g. installation of a bicycle rack with lights), repeated automatic braking may occur in extreme driving conditions.

## Electrically unlocking trailer hook

### Description

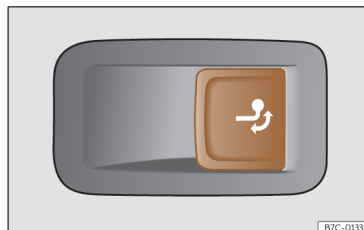

**Fig. 188** On the right side of the luggage compartment: button for unlocking the tow hook.

The towing bracket's hook is located in the bumper. Tow hooks for electrical unlocking cannot be removed.

There should be no person, animal or object in the path of the tow hook >>> .

### Unlocking the tow hook and removing it

- Stop the vehicle and connect the electronic parking brake >>> page 247.
- Switch off the engine.
- Open the rear lid. »

- Pull the **>>> Fig. 188** button briefly. The tow hook unlocks electrically and automatically turns outwards. The button's control lamp flashes.
- Finish remove the tow hook by hand until you feel and hear that it has engaged and the control lamp on the button stays on.
- Close the rear lid.
- Hitching and connecting a trailer **>>> page 277**.

### Retracting the tow hook

- Stop the vehicle and apply the electronic parking brake.
- Switch off the engine.
- Unhook the trailer and interrupt the electrical connection between it and the vehicle. If you are using an adapter, remove it from the trailer's power socket.
- Open the rear lid.
- Pull the **>>> Fig. 188** button briefly. The tow hook unlocks electrically.
- Turn the tow hook under the bumper with your hand until you feel and hear that it engages and the control lamp on the button remains on continuously.
- Close the rear lid.

### The control lamp →

- If the warning light on the button **>>> Fig. 188** → flashes, this means that the

tow hook has not been attached properly or is damaged **>>> ⚠**.

- If the warning lamp **>>> Fig. 188** → remains on with the rear lid open, the tow hook is correctly in place both when extracted and when covered.

The control light of the lamp switches off approximately 1 minute after closing the rear lid.

### ⚠ WARNING

Undue use of the towing bracket may cause injury and accidents.

- Only use the tow hook if it is properly engaged.
- Always ensure that no person, animal or object is to be found in the path of the tow hook.
- Never use a tool or instrument while the tow hook is moving.
- Never press the **>>> Fig. 188** button when there is a trailer hooked to the vehicle or when a carrier system or other accessories are mounted on the tow hook.
- If the tow hook is not attached properly, do not use it. Instead, go to a specialised workshop and have the towing bracket checked.
- If you detect any fault in the electrical system or in the towing bracket, contact a specialised workshop and ask them to check it.

- If the ball has a diameter of less than 49 mm at any one point, do not use the towing bracket under any circumstances.

### ⓘ CAUTION

If you clean the vehicle with high-pressure or steam devices, do not point the jet directly towards the retractable tow hook or the trailer power socket, as this may damage the joints or remove the grease necessary for lubrication.

### ⓘ Note

At extremely low temperatures, the tow hook may be impossible to operate. In this case, place the vehicle in a warmer location (for example, a garage).

### Fitting a bicycle carrier on the retractable towbar

The maximum allowed weight of the carrier system, including the load, is **75 kg**. The carrier system should not protrude more than 700 mm backwards from the spherical head. Only carrier systems on which up to 3 bikes can be mounted are allowed. Heavier bicycles must be mounted as close to the vehicle as possible (tow hook).

**⚠ WARNING**

The incorrect use of the tow hitch with a bicycle rack mounted on the tow hook can cause accidents and injury.

- Never exceed the maximum weight or the limits indicated above.
- The bicycle rack may not be mounted to the neck of the hook below the ball because, due to the shape of the neck and depending on the rack model, the rack could be incorrectly mounted on the vehicle.
- Always read and take the manufacturer assembly instructions into account.

**ⓘ CAUTION**

If the maximum weight and limits indicated above are exceeded, the vehicle may suffer considerable damage.

- Never exceed the values indicated!

**i Note**

CUPRA recommends removing, as far as possible, all removable parts of the bicycles before setting off. These parts include, for example, baskets and saddlebags, child seats or batteries. This improves aerodynamics and the centre of gravity of the rack system.

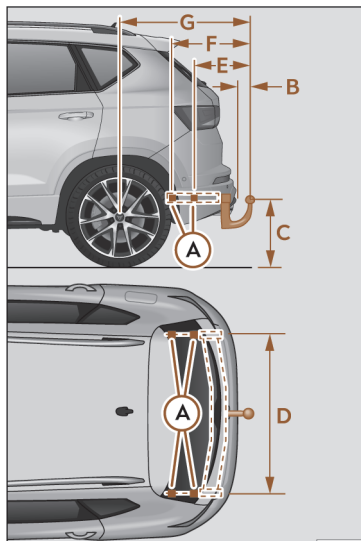
**Retrofitting a towing bracket****Description**

**Fig. 189** Limits and attachment points for retrofitting a towing bracket.

CUPRA recommends that towing brackets be retrofitted at a specialised workshop. For example, it may very well be necessary to adjust the cooling system or mount thermal protection plates. To do so, CUPRA recommends going to a specialised CUPRA dealer or any SEAT dealership.

If a towing bracket is retrofitted, the distance specifications should always be kept in mind.

The distance between the centre of the ball head and the road»» **Fig. 189** **ⓐ** must never be less than that indicated. This also applies when the vehicle is fully loaded, including the technically permissible maximum vertical load on the coupling device.

**Distance specifications»» Fig. 189 :**

- ⓐ** Mounting points on the vehicle
- ⓑ** 65 mm (minimum)
- ⓒ** 350 mm to 420 mm (fully laden vehicle)
- ⓓ** 1,043 mm
- ⓔ** 413.5 mm
- ⓕ** 633.5 mm
- ⓖ** 959 mm

**⚠ WARNING**

If the cables are improperly or incorrectly connected, this may lead to malfunctions in the entire vehicle electronic system, as well as to accidents and serious injuries. »

- Never connect the trailer's electric system to the electrical connections of the tail lights or any other unsuitable power sources. Only use suitable connectors to connect the trailer.
- The towing bracket should be retrofitted only at a specialised workshop.

### WARNING

If the towing bracket is badly fitted or unsuitable, the trailer may separate from the vehicle while driving. This could cause serious accidents and fatal injuries.

### Note

- Only use towing brackets that have been approved by CUPRA for the model in question.
- In some versions, the fitting of a conventional towing hook solution is not recommended. Please consult your Technical Service.

### Practical tips

## Checking and refilling levels

### Refuelling

#### Refuelling

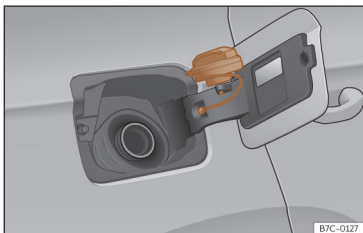

**Fig. 190** Fuel tank flap with tank cap attached.

The fuel tank flap is on the rear right of the vehicle.

The flap that covers the tank cap is unlocked and locked automatically using the central locking.

- Open the fuel tank flap by pressing on the retainer zone.
- Unscrew the cap by turning it to the left.

- Place it in the space on the hinge of the open flap»» Fig. 190 .
- Start refuelling. The tank is full as soon as the pump's automatic nozzle cuts off the fuel supply. Do not try to put in more fuel after the nozzle cuts out, as this will fill the expansion chamber in the fuel tank.
- Unscrew the cap by turning it to the right as far as it will go.
- Close the lid.

The correct fuel grade for your vehicle is given on a sticker on the inside of the fuel tank flap. Further notes on fuel can be found at »» page 286.

The capacity of your vehicle's fuel tank is given in»» page 331 .

#### **⚠ WARNING**

Fuel is highly flammable and can cause serious burns and other injuries.

- When refuelling, turn off the engine and turn off the ignition for safety reasons.
- Do not smoke when filling the fuel tank or a canister. Naked flames are forbidden in the vicinity due to the risk of explosion.
- Observe legislation governing the use, storage and carrying of a spare fuel canister in the vehicle.
- For safety reasons we do not recommend carrying a spare fuel canister in the vehicle.

In an accident the canister could be damaged and could leak.

• If, in exceptional circumstances, you have to carry a spare fuel canister, please observe the following points:

- Never fill fuel into the spare fuel canister if it is inside or on top of the vehicle. This could cause an explosion. Always place the canister on the ground to fill it.
- Insert the filling nozzle as far as possible into the spare fuel canister.
- If the spare fuel canister is made of metal, the filling nozzle must be in contact with the canister during filling. This helps prevent an electrostatic charge building up.
- Never spill fuel in the vehicle or in the luggage compartment. Fuel vapour is explosive. Risk of fatal accident!

#### **ⓘ CAUTION**

- If any fuel is spilt onto the vehicle, it should be removed immediately. It could otherwise damage the paintwork.
- Never run the tank completely dry. The catalytic converter can be damaged.
- When filling the fuel tank after having run it completely dry on a vehicle with a diesel engine, the ignition must be switched on for at least 30 seconds before starting the engine. When you then start the engine it

»

may take longer than normal (up to one minute) to start firing.

#### For the sake of the environment

Do not overfill the fuel tank, it may cause the fuel to overflow if it becomes warm.

#### Note

There is no emergency mechanism for the manual release of the fuel tank flap. If necessary, request assistance from specialised personnel.

#### Note

Diesel vehicles are fitted with a protective device that prevents the insertion of the wrong fuel hose<sup>1)</sup>. It is only possible to refuel with Diesel nozzles.

- If the pump nozzle is worn, damaged, or if it is very small, it is possible that it will not be able to open the protective device. Before trying to insert the pump nozzle by turning it, try a different pump or request specialist help.
- If you fill the tank from a reserve fuel canister, the protective device will not open.

One way to resolve this is to pour the fuel in very slowly.

## Fuel types

### Identification of fuels<sup>1)</sup>

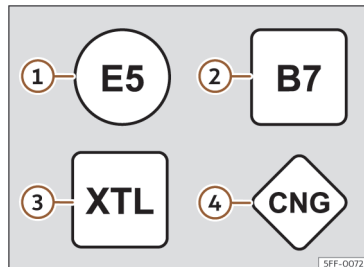

**Fig. 191** Identification of fuels according to European Union (EU) Directive 2014/94/

Fuels are identified by different symbols on the pump and on your vehicle's tank flap. The identification serves to prevent confusion when choosing the fuel.

- 1) **Petrol** with ethanol ("E" stands for Ethanol). The number indicates the percentage of ethanol in the petrol. "E5" means, for example, an ethanol ratio of 5% max.
- 2) **Diesel** according to EN590 standard. The number indicates the maximum percentage of Biodiesel in the fuel. "B7" means a maximum of 7% Biodiesel.
- 3) Synthetic **diesel** according to EN15940 standard.
- 4) **Natural gas**: "CNG" means Compressed Natural Gas.

### Type of petrol

The correct grade of petrol is listed inside the fuel tank flap.

The vehicle is equipped with a catalytic converter and must only be run on **unleaded petrol**. The petrol must comply with the standard EN 228 and be **sulphur-free**. Fuels with a 10% ethanol ratio can be refuelled (E10)<sup>2)</sup>. The types of petrol are differentiated by using the **octane numbers (RON)** or via the **anti-knock index (AKI)**.

<sup>1)</sup> Depending on country

<sup>2)</sup> Follow the regulations of the country you are driving in.



### Unleaded super plus 98 octane petrol or super 95 octane petrol at least

We recommend refuelling with super plus 98 octane petrol (93 AKI). If not available: super 95 octane petrol (91 AKI) (with a slight power loss).

If super is not available, *if necessary*, use normal 91 octane petrol (87 AKI). In this case only use moderate engine speeds and a light throttle. Refuel with super as soon as possible.

#### ⓘ CAUTION

- Fuels high percentage of ethanol, e.g. E30 - E100 button must not be used. The fuel system would be damaged.
- A single refuelling with leaded fuel or other metal additives entails a permanent deterioration of the effectiveness of the catalytic converter.
- Only use fuel additives that have been approved by SEAT. The products that contain substances to increase the octane rating or decrease knocking may contain metal additives that damage the engine and catalytic converter. This type of products must not be used.
- Do not use fuels shown in the pump as containing metals. LRP (*lead replacement petrol*) fuels contain high concentrations of metal additives. Risk of engine damage!
- High engine speed and full throttle can damage the engine when using petrol with

an octane rating lower than the correct grade for the engine.

#### ⓘ Note

- Fuel with an octane rating higher than the one required by the engine can be used.
- In countries in which there is no sulphur-free fuel, it is also allowed to use low sulphur content fuel.

## Engine management and emissions control system

### Introduction

#### ⚠ WARNING

- Due to the high temperatures reached by the exhaust gas scrubbing system, you should not park your vehicle near a surface that can catch fire easily. **Fire hazard!**
- Do not apply wax underneath the vehicle around the area of the exhaust system: **Fire hazard!**

## Control lamps

### It lights up

Fault in the emission control system. Reduce speed and drive carefully to the nearest specialised workshop to have the engine checked.

### Flashes

Combustion failures that can damage the catalytic converter. Reduce speed and drive carefully to the nearest specialised workshop to have the engine checked.

### It lights up



Particulate filter blocked»» page 288 .

### **EPC** It lights up

Fault in the petrol engine management. Have the engine checked as soon as possible by a specialised workshop.

When the ignition is switched on, the **EPC** (Electronic Power Control) lights up and should go off once the engine has started.

#### ⓘ Note

While the indicator lamps ,  or **EPC** are on, there might be faults in the engine, fuel consumption may go up and the engine might lose power.

## Catalytic converter

### To maintain the useful life of the catalytic converter

- Only use unleaded petrol with petrol engines.
- Never run the fuel tank dry.
- When changing or adding engine oil, do not exceed the necessary amount  
»» page 294, Topping up the engine oil.
- Never tow the vehicle to start it, use jump leads if necessary»» page 50.

If you should notice misfiring, uneven running or loss of power when the car is moving, have the vehicle inspected by a specialised workshop. In general, the emissions warning lamp  will light up when any of these symptoms occur. If this happens, any unburnt fuel can enter the exhaust system and escape into the atmosphere. The catalytic converter can also be damaged by overheating.

### ⓘ CAUTION

Never run the fuel tank completely dry because an irregular fuel supply can cause ignition faults. This allows unburnt fuel to enter the exhaust system, which could cause overheating and damage the catalytic converter.

### For the sake of the environment

Even when the emission control system is working perfectly, there may be a smell of sulphur from the gases on occasions. This depends on the sulphur content of the fuel used. This can quite often be avoided by changing to another brand of fuel.

## Particulate filter

The particulate filter eliminates most of the soot from the exhaust gas system. Under normal driving conditions the filter cleans itself. If the filter does not clean itself (e.g. if short journeys are made continuously), it becomes blocked with soot and the following indication is displayed to the driver:  **Particulate filter: cleaned while the vehicle is moving. See Manual.** The particulate filter needs cleaning (regeneration).

### Regeneration of the particulate filter

*Requirements for the regeneration journey:* the engine is at operating temperature.

- Drive at a speed of at least 80 km/h »» 
- Completely remove your foot from the accelerator pedal for a few seconds to let the vehicle roll with the gear engaged.
- Consider the legal speed limits as well as the recommended gears.

- Repeat this procedure (accelerate and let roll) until the control lamp turns off.

This procedure involves an autonomous particulate filter cleaning process and may take some time.

If the warning lamp **does not turn off**, go immediately to a specialised workshop to repair the fault.

### WARNING

Always adjust your speed to suit the weather conditions, roads, braking distance and traffic if the particulate filter is in its regeneration phase. Route recommendations should never make you disregard each country's specific traffic regulations.

### ⓘ CAUTION

- Due to the high temperatures caused by the regeneration of the particulate filter, it is possible that the radiator fan will activate after stopping the engine, even if its operating temperature has not been reached.
- Noise, smells and high idle speeds can occur during regeneration.
- Always use the correct engine oil and the correct fuel to make sure the useful life of the particulate filter is not affected. Also avoid making short trips all the time.

### Engine compartment

#### Working in the engine compartment

Always be aware of the danger of injury and scalding as well as the risk of accident or fire when working in the engine compartment (e.g. when checking and refilling fluids).

Always observe the warnings listed below and follow all general safety precautions.

The vehicle's engine compartment is a potentially hazardous area >>> ⚠.

#### ⚠ WARNING

When work is done in the engine compartment, injuries, burns, accidents and even fires can occur.

- Turn off the engine, disconnect the ignition e and apply the electronic parking brake. Place the selector lever in P. Let the engine cool.
- Never open the bonnet if you see steam or drips of coolant being released from the engine compartment. Wait until no steam or coolant can be seen before opening the bonnet.
- Keep children away from the engine compartment.
- Never spill liquids used for vehicle operation on the engine compartment, as these

may catch fire (e.g. the antifreeze in coolant).

- Avoid causing short-circuits in the electrical system, particularly at the points where the jump leads are attached >>> page 50. The battery could explode.

• If working inside the engine compartment, remember that, even when the ignition is switched off, the radiator fan may start up automatically, and therefore there is a risk of injury.

- Never cover the engine with additional insulating materials such as a blanket. Risk of fire!
- Do not unscrew the cap on the coolant expansion tank when the engine is hot. The cooling system is under pressure.
- Protect face, hands and arms by covering the cap with a large, thick rag to protect against escaping coolant and steam.
- Always make sure you have not left any objects, such as cleaning cloths or tools, in the engine compartment.

• If you have to work underneath the vehicle, you must use suitable stands additionally to support the vehicle, there is a risk of accident!. A hydraulic jack is insufficient for securing the vehicle and there is a risk of injury.

- If any work has to be performed when the engine is started or with the engine running, there is an additional, potentially fatal, safety risk from the rotating parts, such

as the drive belts, alternator, radiator fan, etc., and from the high-voltage ignition system. You should also observe the following:

- Never touch the electrical wiring of the ignition system.
- Ensure that jewellery, loose clothing and long hair do not get trapped in rotating engine parts. Danger of death. Before starting any work remove jewellery, tie back and cover hair, and wear tight-fitting clothes.
- Never accelerate with a gear engaged without taking the necessary precautions. The vehicle could move, even if the handbrake is applied. Danger of death.
- Observe the following additional warnings if work on the fuel system or the electrical system is necessary:
  - Always disconnect the battery from the on-board network.
  - Do not smoke.
  - Never work near naked flames.
  - Always keep an approved fire extinguisher immediately available.

#### 🌿 For the sake of the environment

- Inspect the ground underneath your vehicle regularly so that any leaks are detected at an early stage. If you find spots of oil or other fluids in the area where it was

»

parked, have your vehicle inspected at the workshop.

- Service fluids leaks are harmful to the environment. For this reason you should make regular checks on the ground underneath your vehicle. If you find spots of oil or other fluids, have your vehicle inspected in a specialised workshop.

### **i** Note

In right-hand drive vehicles some brake fluid reservoirs are on the other side of the engine compartment»» Fig. 194.

## Opening and closing the bonnet

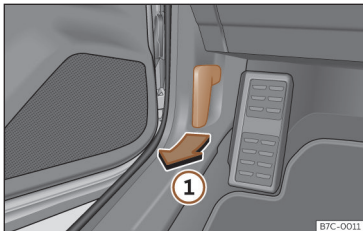

**Fig. 192** Release lever in the driver's footwell area.

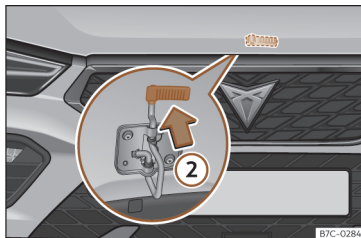

**Fig. 193** Cam under the bonnet

### Opening the bonnet

The bonnet is released from inside the vehicle.

Before opening the bonnet, make sure that the windscreen wiper arms are in place against the windscreen.

- Open the door and pull the lever under the dashboard»» Fig. 192 ①.
- To lift the bonnet, press the release catch under the bonnet upwards»» Fig. 193 ②. The arrester hook under the bonnet is released.
- The bonnet can be opened. Release the bonnet stay and secure it in the fixture designed for this in the bonnet.

### Closing the bonnet

- Slightly lift the bonnet.
- Release the bonnet stay and replace it in its support.
- At a height of approximately 20 cm let it fall so it locks.

If the bonnet does not close, do not press downwards. Open it again and let it fall as mentioned above.

### **⚠** WARNING

Make sure that the bonnet is properly closed. If it opens when driving, it can cause an accident.

### **ⓘ** CAUTION

To avoid damage to the bonnet and to the windscreen wiper arms, only open it when the windscreen wipers are in place against the windscreen.

### Checking levels

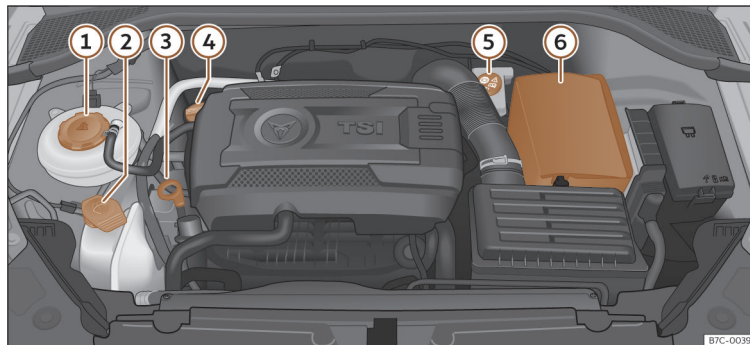

**Fig. 194** Diagram for the location of the various elements.

From time to time, the levels of the different fluids in the vehicle must be checked. Never fill with incorrect fluids, otherwise serious damage to the engine may be caused.

#### **i** Note

**The layout of parts may vary depending on the engine.**

- ① Coolant expansion tank»» page 295
- ② Windscreen washer reservoir  
»» page 298
- ③ Engine oil level dipstick»» page 293
- ④ Engine oil filler cap»» page 294
- ⑤ Brake fluid reservoir»» page 297
- ⑥ Vehicle battery (underneath a cover)  
»» page 299

## Engine oil

### General notes

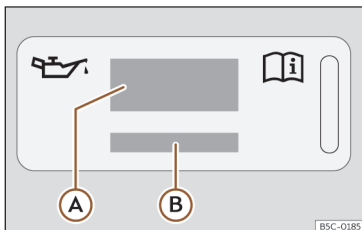

**Fig. 195** In the engine compartment: engine oil label

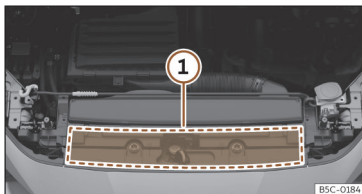

**Fig. 196** In the engine compartment: area where the engine oil label is located

Key to the»» **Fig. 195:**

- A** Information about the engine oil standard.
- B** Information about engine oil viscosity.

The engine comes with a special, multi-grade oil that can be used all year round.

Because the use of high-quality oil is essential for the correct operation of the engine and its long useful life, when topping up or changing oil, use only those oils that comply with VW standards.

#### For vehicles with an engine oil label

If the engine oil has to be topped up, use one of the oils shown on the label»» **Fig. 195**. The label with the prescribed standard is located at the front of the engine compartment»» **Fig. 196** **1**. If you use the recommended engine oil, you can top up the oil as often as necessary.

#### For vehicles without an engine oil label

Contact a specialised workshop or SEAT official service for information about the corresponding standard.

#### If the engine oil level is too low

If the recommended engine oil is not available, in the event of an **emergency** you can change the oil **once** with a maximum of 0.5 L of the next oil until the next oil change:

- *Petrol engines:* VW 504 00, ACEA C3 or API SN standard.

CUPRA recommends changing the oil at a specialised workshop. CUPRA recommends

a specialised CUPRA Service or SEAT Official Service.

CUPRA recommends the use of engine oils approved according to the appropriate VW standard. Use of engine oils that do not meet these quality requirements can cause engine damage.

CUPRA recommends the use of Original SEAT Spare Part engine oils.

#### Engine oil additives

No type of additive should be mixed with the engine oil. The deterioration caused by these additives is not covered by the warranty.

#### **ⓘ CAUTION**

Take the following into account if you have refilled with an engine oil different to those specified in the aforementioned standards, or by your SEAT technical service centre:

- There is no way of completely avoiding the danger of causing damage to the engine and particulate filter.
- You can continue driving with the vehicle if the refill was no more than 0.5 l of engine oil. Go to a specialised workshop as soon as possible and request an oil change. Otherwise, there is a danger of engine damage.
- If you have topped up more than 0.5 l of engine oil, drive with the engine at low load levels and within the medium RPM range as

a maximum. Do not drive at more than 80 km/h and do not travel more than 300 km (approximately). Go to a specialised workshop as soon as possible and request an oil change. Otherwise, there is a danger of engine damage.

- You are responsible for the risk of possible damage to the vehicle (engine, exhaust system). If in doubt, do not start the engine and request assistance from the technical service centre.

- Do not start the engine if you have topped up with a fluid other than engine oil. Request assistance from the technical service centre. Danger of engine damage!

### **i** Note

Before a long trip, we recommend finding an engine oil that conforms to the corresponding VW specifications and recommend keeping it in the vehicle. This way, the correct engine oil will always be available for a top-up if needed.

## Warning lamp

 It lights up red

 Do not carry on driving!  
Engine oil pressure too low.  
Switch off the engine. Check the engine oil level.

If this warning lamp  starts to flash, and is accompanied by three **audible warnings**, switch off the engine and check the oil level. If necessary, add more oil  
»» page 294.

If the warning lamp  flashes although the oil level is correct, **stop driving**. Do not even run the engine at idle speed! Obtain technical assistance.

 It lights up yellow

Check the engine oil level as soon as possible.  
Replace oil as soon as you have the opportunity to do so  
»» page 294.

 It flashes yellow

Fault in the oil level sensor.  
Have the check done by a specialised workshop. Until then it is advisable to check the oil level every time you refuel.

### **⚠** WARNING

Observe the safety warnings »» **⚠** in Control and warning lamps on page 81.

## Checking the engine oil level

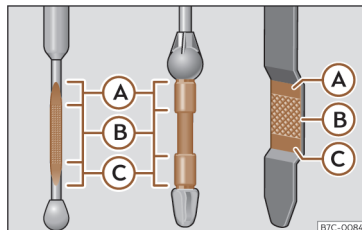

**Fig. 197** Engine oil dipstick.

The engine oil dipstick indicates the level of the oil.

### Checking oil level

- Park the vehicle in a horizontal position.
- Briefly run the engine at idle speed until the operating temperature is reached and then stop.
- Wait for about two minutes.
- Pull out the dipstick. Wipe the dipstick with a clean cloth and insert it again, pushing it in as far as it will go.
- Then pull it out once more and check the oil level»» **Fig. 197**. Top up with engine oil if necessary.

The oil must leave a mark between zones **(A)** and **(C)**. It can never go above zone **(A)**. »»

- Zone **(A)**: do not add oil.
- Zone **(B)**: you can add oil but keep the level in that zone.
- Zone **(C)**: add oil until zone **(B)**.

Depending on how you drive and the conditions in which the vehicle is used, oil consumption can be up to 0.5 l/1000 km. Oil consumption is likely to be higher for the first 5,000 km. For this reason the engine oil level must be checked at regular intervals, preferably when filling the tank and before a journey.

#### **⚠ WARNING**

Any work carried out in the engine compartment or on the engine must be carried out cautiously.

- When working in the engine compartment, always observe the safety warnings >>> page 289.

#### **ⓘ CAUTION**

If the oil level is above area **(A)**, do not start the engine. This could result in damage to the engine and catalytic converter. Contact a Technical Service.

### Topping up the engine oil



**Fig. 198** In the engine compartment: Engine oil filler cap.

Before opening the bonnet, read and observe the warnings >>> **⚠** in Working in the engine compartment on page 289.

#### Topping up engine oil

- Unscrew cap from engine oil filler opening >>> **Fig. 198**.
- Carefully add oil in small quantities (no more than 0.5 l).
- To avoid adding too much oil, whenever you add a certain amount, wait about 2 minutes and recheck the oil level >>> page 293.
- If necessary, add some more oil.
- When the oil level reaches at least zone >>> **Fig. 197 (B)**, unscrew the engine oil filler cap carefully >>> **ⓘ**.

The position of the oil filler opening is shown in the corresponding engine compartment illustration >>> page 291.

Engine oil specification >>> page 292.

#### **⚠ WARNING**

Oil is highly inflammable! Ensure that no oil comes into contact with hot engine components when topping up.

#### **ⓘ CAUTION**

If the oil level is above area >>> **Fig. 197 (A)**, do not start the engine. This could result in damage to the engine and catalytic converter. Contact a specialised workshop.

#### **🌿 For the sake of the environment**

The oil level must never be above zone >>> **Fig. 197 (A)**. Otherwise oil can be drawn in through the crankcase breather and leak into the atmosphere via the exhaust system.

#### **ⓘ Note**

Before a long trip, we recommend finding an engine oil that conforms to the corresponding VW specifications and recommend keeping it in the vehicle. This way, the correct engine oil will always be available for a top-up if needed.



### Engine oil change

We recommend that you have the engine oil changed by a Technical Service.

#### ⚠ WARNING

Only change the engine oil yourself if you have the specialist knowledge required!

- Before opening the bonnet, read and observe the warnings»» page 289.
- Wait for the engine to cool down. Hot oil may cause burn injuries.
- Wear eye protection to avoid injuries, such as acid burns, caused by splashes of oil.
- When removing the oil drain plug with your fingers, keep your arm horizontal to help prevent oil from running down your arm.
- Wash your skin thoroughly if it comes into contact with engine oil.
- Engine oil is poisonous! Used oil must be stored in a safe place out of the reach of children.

#### ⓘ CAUTION

No additives should be used with engine oil. This could result in engine damage. Any damage caused by the use of such additives would not be covered by the factory warranty.

#### ♻ For the sake of the environment

- We recommend that you change the engine oil and the filter at a technical service centre.
- Never pour oil down drains or into the ground.
- Use a suitable container when draining the used oil. It must be large enough to hold all the engine oil.

## Cooling system

### Coolant specifications

The engine cooling system is supplied from the factory with a specially treated mixture of water and at least 40 % of the additive **G12evo** (TL-VW 774 J), purple. This mixture gives the necessary frost protection down to -25°C (-13°F) and protects the light alloy parts of the engine cooling system against corrosion. It also prevents scaling and considerably raises the boiling point of the coolant.

To protect the cooling system, the percentage of additive must always be at least 40 %, even in warm climates where anti-freeze protection is not required.

If for weather reasons further protection is necessary, the proportion of additive may be

increased, but only up to 60 %; otherwise antifreeze protection will diminish and this will worsen cooling.

When the coolant is topped up, use a mixture of **distilled water** and at least 40 % of the additive **G12evo** for optimal protection against corrosion. Mixing **G12evo** with G13 (TL-VW 774 J), G12 plus-plus (TL-VW 774 G), G12 plus (TL-VW 774 F), G12 (red) or G11 (green blue) engine coolants decreases protection against corrosion and should be avoided.

#### ⚠ WARNING

If there is not enough anti-freeze in the coolant system, the engine may fail leading to serious damage.

- Ensure that the percentage of additive is correct for the lowest expected ambient temperature in the zone in which the vehicle is to be used.
- When the outside temperature is very low, the coolant could freeze and the vehicle would be immobilised.

#### ⓘ CAUTION

The original additives should never be mixed with coolants which are not approved by SEAT.

- If the fluid in the expansion tank is not purple but is, for example, brown, this indicates that the **G12evo** additive has been

»

mixed with an inadequate coolant. The coolant must be changed as soon as possible if this is the case!

### For the sake of the environment

Coolants and additives can contaminate the environment. If any fluids are spilled, they should be collected and correctly disposed of, with respect to the environment.

## Refilling coolant

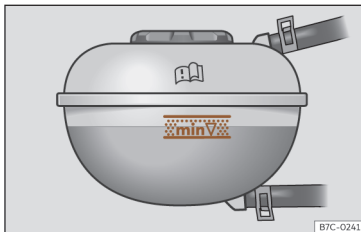

**Fig. 199** In the engine compartment: marking on coolant expansion tank.



**Fig. 200** Engine compartment: coolant expansion tank cap.

The coolant tank is located in the engine compartment»» page 291.



Top up coolant when the level is below the **MIN** (minimum) mark.

### Checking coolant level

- Park the vehicle in a horizontal position.
- Switch the ignition off.
- Read off the coolant level on coolant expansion tank. When the engine is cold, the coolant level should be between the marks »» **Fig. 199**. When the engine is hot, it may be slightly above the upper mark.

### Topping up coolant

- Wait for the engine to cool down.

- Cover the coolant expansion tank cap with a cloth and carefully unscrew it to the left »» .
- Top up the coolant only if there is still coolant in the expansion tank, otherwise you could **damage the engine**. If there is no coolant in the expansion tank, do not continue driving. You should obtain professional assistance »» .
- If there is still some coolant in the expansion tank, top up to the upper mark.
- Top up with coolant until the level becomes stable.
- Screw the cap back on correctly.

If there is a coolant leak, take the vehicle specialised workshop to have the cooling system examined.

### **WARNING**

- The cooling system is under pressure. Do not unscrew the cap on the coolant expansion tank when the engine is hot: risk of burns!
- Store the antifreeze in its original container and keep it out of reach of children.
- If working inside the engine compartment, remember that, even when the ignition is switched off, the radiator fan may start up automatically, and therefore there is a risk of injury.

### ⓘ CAUTION

If you run out of coolant in the expansion tank, park the car in a safe place and do not continue driving. Obtain technical assistance.

## Brake fluid

### Check and refill the brake fluid



**Fig. 201** Engine compartment: brake fluid reservoir cap.

The brake fluid reservoir is located in the engine compartment»» page 291.

### Checking the brake fluid level

The brake fluid level must be between the **MIN** and **MAX** markings.

However, if the brake fluid level goes down noticeably in a short time, or drops below the **MIN** mark, there may be a leak in the brake system. Seek specialist assistance. A warning light on the instrument panel displays the brake fluid level»» page 80.

In right-hand drive vehicles the brake fluid reservoir is on the other side of the engine compartment.

### Changing brake fluid

We recommend that you have the brake fluid changed by a Technical Service.

### ⚠ WARNING

If the brake fluid level is low or unsuitable/old brake fluid is used, the brake system may fail or braking power may be reduced.

- Check the brake system and the brake fluid level regularly!
- When the brake fluid is used and brakes are subjected to extreme braking forces, bubbles of vapour form in the brake system. These bubbles can significantly reduce braking power, notably increasing braking distance, and could result in the total failure of the brake system.
- Be sure to always use the correct brake fluid. Only use brake fluid that expressly meets the VW 501 14 standard.

- You can buy VW 501 14 standard brake fluid at a specialised CUPRA service or at a SEAT Official Service. If none is available, use only high-quality brake fluid that meets DIN ISO 4925 CLASS 4 standards, or USA Standards FMVSS 116 DOT 4.

- The replacement brake fluid must be new.
- Brake fluid should be stored in the closed original container in a safe place out of reach of children. Risk of poisoning!

### ⓘ CAUTION

Brake fluid should not come into contact with the vehicle paintwork, as it is abrasive.

### ♻ For the sake of the environment

Brake fluid is an environmental pollutant. Collect any spilt service fluids and allow a professional to dispose of them.

## Windscreen washer reservoir

### Checking the level of the window washer tank and refilling it





**Fig. 202** In the engine compartment: window washer tank cap.

The window washer tank is in the engine compartment»» page 291.

Check the water level in the windscreen washer reservoir regularly and top up as required.

The container for the windscreen washer contains the cleaning fluid for the windscreen, the rear window and the headlight washer system.

- Open the bonnet »» page 289.
- The window washer tank is marked with the  symbol on the cap.

- Check there is enough windscreen water in the reservoir.

Plain water is not enough to clean the windscreen and headlights. We recommend that you always add a product to the windscreen washer fluid.

### Recommended windscreen wipers

- For the hottest seasons we recommend summer G 052 184 A1 for clear glass. Proportions of the mixture in the washer fluid tank: 1:100 (1 part concentrate per 100 parts water).
- All year round, G 052 164 A2 for clear glass. Approximate proportion of the winter mixture, up to  $-18^{\circ}\text{C}$  ( $0^{\circ}\text{F}$ ): 1:2 (1 part concentrate per 2 parts water); otherwise, a 1:4 proportion of mixture in the washer fluid tank.

The capacity of the window washer tank can be found in»» page 331.

### ⓘ CAUTION

If the water from the windscreen washer does not contain enough anti-freeze, it may freeze on the windscreen and rear window, reducing forward and rear visibility.

- In winter, ensure the windscreen washer contains enough anti-freeze.
- In cold conditions, you should not use the windscreen wiper system unless you have

warmed the windscreen with the ventilation system. The antifreeze could freeze on the windscreen and reduce visibility.

### ⓘ CAUTION

Never mix an unsuitable antifreeze or other similar additives with the windscreen washer water. A greasy layer may be formed on the windscreen which will impair visibility.

- Use clean water with a window cleaner recommended by CUPRA.
- If necessary, add a suitable antifreeze to the water in the reservoir.

### ⓘ CAUTION

Do not mix cleaning products recommended by CUPRA with other products. This could lead to flocculation and may block the windscreen washer jets.

- When topping up service fluids, make absolutely certain that you fill the fluids into the correct reservoirs. Using the wrong fluids could cause serious malfunctions and engine damage!
- Not having windscreen wiper fluid reduces visibility through the windscreen, and leads to loss of visibility in headlights in models with headlight washer.

## 12-volt battery





### General information

The battery is located in the engine compartment and is almost **maintenance-free**. It is checked as part of the Inspection Service. Nevertheless, check the terminals are clean and have the correct tightening torque, especially in summer and winter.

All work on batteries requires specialist knowledge. Please refer to a specialised CU-PRA Service, SEAT Official Service or a workshop specialising in batteries: risk of burns or exploding battery!

**The battery must not be opened.** Never try to change the fluid level of the battery. Otherwise explosive gas is released from the battery that could cause an explosion.

### Battery warning indications

	Wear eye protection.
	Battery acid is extremely corrosive. Wear protective gloves and eye protection. Rinse any splashes of electrolyte with plenty of water.
	Fires, sparks, open flames and smoking are prohibited.
	The battery should only be charged in a well-ventilated zone. Risk of explosion!
	Keep children away from acid and batteries!



Always follow the instruction manual.

### Disconnecting the battery

The battery should only be disconnected in exceptional cases. When the battery is disconnected, some of the vehicle's functions are lost. These functions will require resetting after the battery is reconnected.

When disconnecting the battery from the vehicle on-board network, disconnect first the negative cable and then the positive cable.

Deactivate the anti-theft alarm before you disconnect the battery. Otherwise the alarm will be triggered.

### If the vehicle is not used for long periods

The vehicle has a system for monitoring the current consumption when the engine is left unused for long periods of time»» page 301. Some functions, such as the interior lights, or the remote door opening, may be temporarily disabled to prevent the battery from running flat. These functions will come back on as soon as the ignition is switched on and the engine started.

### Winter conditions

During the winter, the starting power may be reduced, and if necessary, the battery should be charged»» page 301.

### ⚠ WARNING

Always be aware of the danger of injury and chemical burns as well as the risk of accident or fire when working on the battery and the electrical system:

- Wear eye protection. Protect your eyes, skin and clothing from acid and particles containing lead.
- Battery acid is extremely corrosive. Wear protective gloves and eye protection. Do not tilt the batteries. This could spill acid through the vents.
- Neutralise any electrolyte splashes on the skin, eyes or clothing with a soapy solution, and rinse off with plenty of water. If acid is swallowed by mistake, consult a doctor immediately.
- Fires, sparks, open flames and smoking are prohibited. When handling cables and electrical equipment, avoid causing sparks and electrostatic charge. Never short the battery terminals. High-energy sparks can cause injury.
- A highly explosive mixture of gases is released when the battery is under charge. The batteries should be charged in a well-ventilated room only.
- Keep children away from acid and batteries.
- Before working on the electrical system, you must switch off the engine, the ignition and all electrical devices. The negative cable on the battery must be disconnected. »

When a light bulb is changed, you need only switch off the light.

- Deactivate the anti-theft alarm by unlocking the vehicle before you disconnect the battery! The alarm will otherwise be triggered.
- When disconnecting the battery from the vehicle on-board network, disconnect first the negative cable and then the positive cable.
- Switch off all electrical devices before reconnecting the battery. Reconnect first the positive cable and then the negative cable. Never reverse the polarity of the connections. This could cause an electrical fire.
- Never charge a frozen battery, or one which has thawed. This could result in explosions and chemical burns. Always replace a battery which has frozen. A flat battery can also freeze at temperatures close to 0°C (+32°F).

- Ensure that the vent hose is always connected to the battery.
- Never use a defective battery. This could cause an explosion. Replace a damaged battery immediately.

### ⚠ WARNING

The 12 volt battery is a subject to wear. A reduction in battery power can mean that some important safety systems, such as power steering, braking intervention, lights or airbag systems, operate with limitations

or stop working entirely. This may cause serious accidents and injuries. To avoid this, it is necessary to take the following safety measure:

- Get a professional service centre to replace the 12-volt vehicle battery every four years.

### ⓘ CAUTION

- Do not expose the battery to direct sunlight over a long period of time, as the intense ultraviolet radiation can damage the battery housing.
- If the vehicle is left standing in cold conditions for a long period, protect the battery from "freezing". If it freezes it will be damaged.

## Control lamp

 It lights up red

Alternator fault.

The control lamp lights up when the ignition is switched on. It should go out when the engine has started running.

If the control lamp  lights up while driving, the alternator is no longer charging the battery. You should immediately drive to the nearest specialised workshop.

You should avoid using electrical equipment that is not absolutely necessary because this will drain the battery.

## Checking the battery electrolyte level

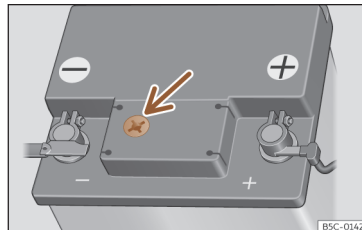

**Fig. 203** Sight glass on the top of the 12 volt battery (schematic representation).

The electrolyte level should be checked regularly in high-mileage vehicles, in hot countries and in older batteries.

- Open the bonnet and then lift the cover that protects the front part of the battery >>>  in Working in the engine compartment on page 289.
- Check the colour display in the "magic eye" on the top of the battery.
- If there are air bubbles in the window, tap the window gently until they disperse.

The position of the battery is shown in the corresponding engine compartment diagram»» page 291.

The “magic eye” indicator, located on the top of the battery changes colour, depending on the charge state and electrolyte level of the battery.

There are two different colours:

**Yellow or colourless:** The battery's electrolyte level is too low. Go to a specialised workshop to have the battery checked and replaced if necessary.

**Black:** The battery's electrolyte level is correct.

### Charging or changing the battery

If you often drive short distances or if the vehicle is not driven for long periods, the battery should be checked by a specialised workshop between the scheduled services.

If the battery has discharged and you have problems starting the vehicle, the battery might be damaged. If this happens, we recommend you have the vehicle battery checked by a Technical Service where it will be re-charged or replaced.

### Charging the battery

The vehicle battery should be charged by a specialised workshop only, as batteries using special technology have been installed and they must be charged in a controlled environment.

### Replacing a vehicle battery

The 12-volt vehicle battery has been designed to suit its location and has specific safety features. If the battery needs to be replaced, it is recommended that it be installed by an official CUPRA qualified workshop. These workshops have the technical documentation and equipment required to find out the size, technology, and maintenance and safety requirements of the new battery.

Start-Stop systems (»» page 199) are equipped with a special battery. Therefore, it must only be replaced with a battery of the same specifications.

Your vehicle is equipped with an intelligent power management system to control the distribution of electrical energy»» page 301. The power management function ensures that the battery is charged much more efficiently than on vehicles without a power management system. To maintain this function after replacing the battery, we recommend that the replacement battery used is of the same make and type as the original fitted battery. To make proper use of the power

management function after the battery has been changed, have the battery coded to the power management mode at a specialised workshop.

#### WARNING

- Always use only maintenance free batteries that do not run flat alone and whose properties, specifications and size correspond to the standard battery. The specifications are indicated on the battery case.
- Before starting any work on the batteries, you must read and observe the warnings »»  in General information on page 299.

#### For the sake of the environment

 Batteries contain toxic substances such as sulphuric acid and lead. They must be disposed of appropriately and must not be disposed of with ordinary household waste.

## Energy management

### Optimisation of the starting capacity

The power management controls the distribution of electrical energy and thus helps to ensure that there is always enough power available to start the engine. »»

If a vehicle with a conventional electrical system is left parked for a long time, the battery will gradually lose its charge because certain electrical devices, such as the electronic gearbox lock continues to draw current even when the ignition is off. In some cases there may not be enough power available to start the engine.

Your vehicle is equipped with an intelligent power management system to control the distribution of electrical energy. This significantly improves reliability when starting the engine, and also prolongs the useful life of the battery.

The main functions incorporated in the power management system are **battery diagnosis**, **residual current management** and **dynamic power management**.

### Battery diagnosis

The battery diagnosis function constantly registers the condition of the battery. Sensors detect the battery voltage, battery current and battery temperature. This enables the system to calculate the current power level and charge condition of the battery.

### Residual current management

The residual current management reduces power consumption while the vehicle is parked. It controls the supply of power to the various electrical devices while the ignition is

switched off. The system takes the battery diagnosis data into consideration.

Depending on the power level of the battery, switch off the individual electrical devices one after the other to prevent the battery from losing too much charge and to ensure that the engine can be started reliably.

### Dynamic power management

While the vehicle is moving, this function distributes the available power to the various electrical devices and systems according to their requirements. The power management ensures that on-board systems do not consume more electrical power than the alternator can supply, and thus maintains the maximum possible battery power level.

#### Note

- Neither is the power management system able to overcome the given physical limits. Please remember that the power and useful life of the battery are limited.
- If there is a risk that the vehicle may not start, the alternator electrical failure or low battery charge level warning lamp will be shown  page 300.

### Flat battery

Starting ability has first priority.

Short trips, city traffic and low temperatures all place a heavy load on the battery. In these conditions a large amount of power is consumed, but only a small amount is supplied. The situation is also critical if electrical devices are in use when the engine is not running. In this case power is consumed when none is being generated.

In these situations you will be aware that the power management system is intervening to control the distribution of electrical power.

### When the vehicle is parked for long periods

If you do not drive your vehicle for a period of several days or weeks, the power management will gradually shut off the electrical devices one by one or reduce the amount of current they are using. This limits the amount of power consumed and helps to ensure reliable starting even after a long period. Some convenience functions, such as remote vehicle opening, may not be available under certain circumstances. These functions will be restored when you switch on the ignition and start the engine.

### With the engine switched off

For example, if you listen to the sound system with the engine switched off the battery will run down.



If the energy consumption means there is a risk that the engine will not start, a text will be displayed in vehicles with a driver information system.

This driver indicator tells you that you must start the engine so that the battery can recharge.

### When the engine is running

Although the alternator generates electrical power, the battery can still become discharged while the vehicle is being driven.

This can occur when a lot of power is being consumed but only a small amount supplied, especially if the battery is not fully charged initially.

To restore the necessary energy balance, the system will then temporarily shut off the electrical devices that are using a lot of power, or reduce the current they are consuming. Heating systems in particular use a large amount of electrical power. If you notice, for instance, that the seat heating or the rear window heater is not working, they may have been temporarily switched off or regulated to a lower heat output. These systems will be available again as soon as sufficient electrical power is available.

You may also notice that the engine runs at a slightly faster idling speed when necessary. This is quite normal, and no cause for concern. The increased idling speed allows the

alternator to meet the greater power requirement and charge the battery at the same time.

## Wheels

### Wheels and tyres

#### General notes

- When driving with **new tyres**, be especially careful during the first 500 km (300 miles).
- If you have to drive over a kerb or similar obstacle, drive very slowly and as near as possible at a right angle to the obstacle.
- Check from time to time if the tyres are damaged (punctures, cuts, cracks or dents). Remove any foreign objects embedded in the treads.
- Damaged wheels and tyres must be replaced immediately.
- Keep grease, oil and fuel off the tyres.
- Replace any missing valve caps as soon as possible.
- Mark the wheels before taking them off so that they rotate in the same direction when put back.
- When removed, the wheels or tyres should be stored in a cool, dry and preferably dark place. »

### Low profile tyres

Low profile tyres have a wider tread, a larger wheel diameter and a lower sidewall height. Therefore, its driving behaviour is more agile.

Low profile tyres may deteriorate more quickly than standard tyres, for instance due to strong knocks, potholes, manhole covers and kerbs. Correct tyre pressure is very important»» page 306 .

To avoid damage to tyres and wheels, drive with special care when driving on roads in poor condition.

Visually check your wheels every 3000 km.

If the tyres or rims have received a heavy impact or have been damaged, have a specialised workshop check whether or not it is necessary to change the tyre.

Low profile tyres may deteriorate more quickly than standard tyres.

### Concealed damage

Damage to tyres and rims is often not readily visible. If you notice unusual **vibration** or the car **pulling to one side**, this may indicate that one of the tyres is damaged. Reduce speed immediately if there is any reason to suspect that damage may have occurred. Inspect the tyres for damage. If no external damage is visible, drive slowly and carefully to the nearest specialised workshop and have the car inspected.

### Foreign objects inserted in the tyre

- Do not remove foreign bodies if they have penetrated through the tyre wall!
- If the vehicle comes with a tyre mobility system, where necessary seal the damaged tyre as shown in section»» page 42 . Use a specialised workshop for repair or replacement. To do so, CUPRA recommends going to a specialised CUPRA dealer or any SEAT dealership.

The sealant at the lower part of the tyre tread wraps around the foreign body and provisionally seals the tyre.

### Tyres with directional tread pattern

An arrow on the tyre sidewall indicates the direction of rotation on single drive tyres. Always note the direction of rotation indicated when mounting the wheel. This makes sure that optimal use is made of tyre properties in terms of aquaplaning, grip, excessive noise and wear.

### Subsequent fitting of accessories

If you wish to change or fit wheels, rims or wheel trims, we recommend that you consult with a specialised CUPRA Service or SEAT Official Service centre for advice regarding current technical recommendations.

### Speed symbols

The speed rating indicates the maximum speed permitted for the tyres.

P	max. 150 km/h (93 mph)
Q	max. 160 km/h (99 mph)
R	max. 170 km/h (106 mph)
S	max. 180 km/h (112 mph)
T	max. 190 km/h (118 mph)
U	max. 200 km/h (124 mph)
H	max. 210 km/h (130 mph)
V	max. 240 km/h (149 mph)
Z	max. 240 km/h (149 mph)
W	max. 270 km/h (168 mph)
Y	max. 300 km/h (186 mph)

Some manufacturers use the letters “ZR” for tyres with a maximum authorised speed above 240 km/h (149 mph).

### WARNING

- **New tyres do not have maximum grip during the first 500 km. Drive particularly carefully to avoid possible accidents.**
- **Never drive with damaged tyres. This may cause an accident.**
- **If you notice unusual vibrations or if the vehicle pulls to one side when driving, stop the vehicle immediately and check the tyres.**

- Never use old tyres or those with an unknown history of use.

## New wheels and tyres

It is best to have all wheels and tyres serviced by a specialised workshop. There they have the required knowledge, the special tools and the corresponding spare parts.

- Even winter tyres lose their grip on ice. If you have installed new tyres, drive the first 500 km carefully and at a moderate speed.
- All four wheels must be fitted with tyres of the same type, size (rolling circumference) and, if possible, tread pattern.
- When changing tyres, do not change just one; change at least two on the same axle.
- If you want to equip your vehicle with a combination tyres and rims that are different to those fitted in the factory, inform your specialised workshop before purchasing them »» » ⚠

The sizes of the rims and tyres approved for your vehicle are listed in the vehicle documentation (e.g. EC Certificate of Conformity or COC document<sup>1)</sup>). The vehicle documentation varies depending on the country of residence.

<sup>1)</sup> COC = certificate of conformity.

If the type of spare wheel is different from the normal wheels — e.g. in the case of winter tyres or particularly wide tyres — the spare wheel should only be used temporarily in the event of a puncture, and the vehicle should be driven with care. Refit the normal road wheel as soon as possible.

In vehicles with four-wheel drive, the 4 wheels must be fitted with tyres of the same brand, type and tread so that the traction system is not damaged by a difference in the number of turns of the wheels. Therefore, in the event of a puncture, only a spare wheel with the same perimeter as normal tyres should be used.

### Manufacturing date

The manufacturing date is also indicated on the tyre sidewall (or on the inside face of the wheel):

DOT ... 2218 ...

it means, for example, that the tyre was manufactured in the 22nd week of 2018.

### ⚠ WARNING

- Use only combinations of tyres and rims, as well as suitable wheel nuts, approved by CUPRA. Otherwise the vehicle may be damaged, causing an accident.

- For technical reasons it is not possible to use wheels of other vehicles; in some cases not even wheels from the same vehicle model should be used.

- Always ensure that the tyres you have chosen have adequate clearance. When selecting replacement tyres, do not rely entirely on the nominal tyre size marked on the tyre, since the nominal tyre size can differ significantly depending on the manufacturer. Lack of clearance can damage the tyres or the vehicle and, as a result, endanger road safety. Risk of accident!

- Only use tyres that are over 6 years old in an emergency, and drive with due care.

- The fitting of tyres with run-flat properties is not permitted on your vehicle! Prohibited use can cause accidents or can damage your vehicle.

- If decorative hubcaps are subsequently fitted, make sure that they allow enough air in to cool the braking system. Risk of accident!

- Models with aerodynamic wheel rims and/or with bolt-on plastic elements (more closed design) increase the likelihood of ice and snow accumulating on the inside. This should be taken into account, depending on the driving situations, as snow or ice accumulated in the wheels can cause vibration in the vehicle when it drives at over 40 »»

km/h. It is advisable to remove ice and snow from the inside of the wheels using hot water.

- If you drive on dirt or gravel tracks, the likelihood of stones becoming trapped inside wheel rims with plastic elements increases when driving at high speed or in a sporty manner. If you see that there are stones trapped between the aluminium wheel rim and the insert, you can attempt to remove them using pressurised water.

#### For the sake of the environment

Old tyres must be disposed of according to the laws in the country concerned.

#### Note

- A CUPRA Service Centre should be consulted to find out whether wheels or tyres of different sizes to those originally fitted by CUPRA can be fitted, and to find out about the combinations allowed between the front axle (axle 1) and the rear axle (axle 2).
- Never mount used tyres if you are not sure of their “previous history”.
- When 245/40 R19 or 245/35 R20 tyres are fitted, the corresponding deflector must also be installed.

## Tyre life

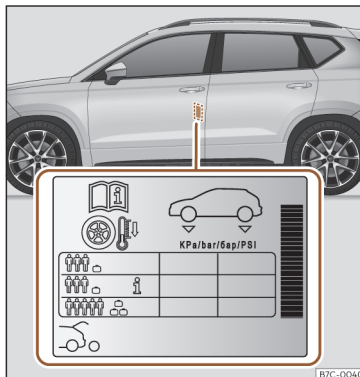

**Fig. 204** Location of the tyre pressure sticker.

Correct inflation pressures and sensible driving habits will increase the useful life of your tyres.

- Check tyre pressure at least once a month, and also prior to any long trip.
- The tyre pressure should only be checked when the tyres are *cold*. Do not reduce the pressure of warm tyres.
- Adjust tyre pressure to the load being carried by the vehicle»» **Fig. 204**.

- In vehicles with a tyre pressure indicator, save the modified tyre pressure »» page 310.
- Avoid fast cornering and hard acceleration.
- Inspect the tyres for irregular wear from time to time.

## Tyre pressure

The tyre inflation pressures are listed on a sticker on the rear of the front left door frame»» **Fig. 204**.

Insufficient or excessive pressure greatly reduces the useful life of the tyres and adversely affects vehicle performance and ride. Correct inflation pressures are very important, especially at **high speeds**.

Depending on the vehicle, tyre pressure can be adjusted to medium load to improve driving comfort (tyre pressure **i**)»» **Fig. 204**). When driving with comfort tyre pressure fuel consumption may increase slightly.

The tyre pressure must be adjusted according to the load the vehicle is carrying. If the vehicle is going to carry the maximum load, the tyre pressure should be increased to the maximum value indicated on the sticker »» **Fig. 204**.

Do not forget the spare wheel when checking the tyre pressures: Keep this spare wheel inflated to the highest pressure required for the road wheels.

In the case of a minimised temporary spare wheel (125/70 R18) inflate to a pressure of 4.2 bar as indicated on the tyre pressure label»» **Fig. 204**.

### Driving style

Fast cornering, heavy acceleration and hard braking (squealing tyres) all increase tyre wear.

### Wheel balance

The wheels on new vehicles are balanced. However, certain circumstances may lead to imbalance (run-out), which is detected as vibrations in the steering wheel.

Unbalanced wheels should be rebalanced, as they otherwise cause excessive wear on steering, suspension and tyres. A wheel must also be rebalanced when a new tyre is fitted or if a tyre is repaired.

### Incorrect wheel alignment

Incorrect running gear alignment causes excessive tyre wear, impairing the safety of the vehicle. If you notice excessive tyre wear, you should check wheel alignment at a specialised CUPRA Service or SEAT Official Service.

### WARNING

Unsuitable handling of the wheels and tyres may lead to sudden tyre pressure losses, to tread separation or even to a blow-out.

- The driver is responsible for ensuring that all of the vehicle tyres are correctly inflated to the right pressure. The recommended tyre pressure is indicated on the label »» **Fig. 204**.
- Check tyre pressures regularly and ensure they are maintained at the pressures indicated. Tyre pressure that is too low could cause overheating, resulting in tread detachment or even burst tyres.
- When the tyres are cold, tyre pressure should be that indicated on the label »» **Fig. 204**.
- Regularly check the cold inflation pressure of the tyres. If necessary, change the tyre pressure of the vehicle tyres while they are cold.
- Regularly check your tyres for damage and wear.
- Never exceed the maximum permitted speed or loads specified for the type of tyre fitted on your vehicle.

### For the sake of the environment

Under-inflated tyres will increase fuel consumption.

### Tread wear indicators

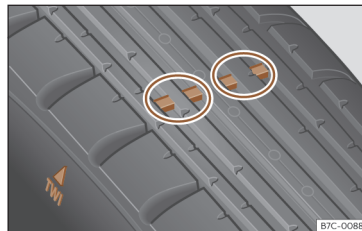

**Fig. 205** Tyre profile: tread wear indicators.

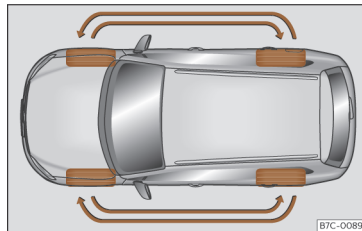

**Fig. 206** Interchanging tyres.

Wear indicators around 1.6 mm high can be found on the base of the original tyre treads, ordered at regular intervals and running across the tread»» **Fig. 205**. The letters "TWI" or triangles on the sidewall of the tyre mark the position of the wear indicators. »

The minimum permitted profile depth<sup>1)</sup> have been reached when the tyres have worn down to the wear indicators. Replace the tyres with new ones >>> .

### Changing wheels around

To ensure that the wear is equal on all tyres the wheels should be changed round from time to time according to the system >>> **Fig. 206**. The useful life of all the tyres will then be about the same time.

#### WARNING

The tyres must be replaced at the latest when the tread is worn down to the tread wear indicators. Failure to follow this instruction could result in an accident.

- Particularly in difficult driving conditions such as wet or icy roads. It is important that the tyre tread be as deep as possible and be approximately the same on the tyres of both the front and the rear axles.
- The scant driving safety due to insufficient tread depth is particularly evident in vehicle handling, when there is a risk of “aquaplaning” in deep puddles of water and when driving through corners, and braking is also adversely affected.

- The speed has to be adapted accordingly, otherwise there is a risk of losing control over the vehicle.

### Wheel nuts

The **wheel nuts** are matched to the rims. When installing different wheels (for instance alloy wheels or wheels with winter tyres) it is important to use the correct wheel nuts with the right length and correctly shaped bolt heads. This ensures that wheels are fitted securely and that the brake system functions correctly.

The wheel nuts must be clean and turn easily.

A special adapter is required to remove the anti-theft wheel bolts >>> page 45.

#### WARNING

Wheel nuts should never be greased or oiled.

- Use only wheel nuts which belong to the wheel.
- If the prescribed torque of the wheel nuts is too low, they could loosen whilst the vehicle is in motion. Risk of accident! If the

tightening torque is too high, the wheel nuts and threads can be damaged.

#### CAUTION

See >>> page 47 to find out the recommended tightening torque for wheel nuts for steel and alloy rims.

### Winter tyres

- Winter tyres must be fitted **on all four** wheels.
- Only use winter tyres that are approved for your vehicle.
- Please note that the maximum permissible speed for winter tyres may be lower than for summer tyres.
- Also note that winter tyres are no longer effective when the **tread** is worn down.
- After fitting the wheels you must always check the tyre pressures. When doing so, take into account the correct tyre pressures listed on the rear of the front left door frame >>> page 306.

In winter road conditions winter tyres will considerably improve vehicle handling. The

<sup>1)</sup> Follow the regulations of the country you are driving in.

design of summer tyres (width, rubber compound, tread pattern) gives less grip on ice and snow. This applies particularly to vehicles equipped with **wide section tyres** or with **high speed tyres** (code letters H, V or Y on the sidewall).

Only use winter tyres of the correct type approved for your vehicle. The sizes of these tyres are specified in the vehicle's documents (e.g. EC Certificate of Conformity or COC<sup>1)</sup>). The vehicle documentation varies depending on the country of residence.

Winter tyres lose a great deal of their properties when the **tread** is worn down to a depth of 4 mm.

The performance of winter tyres is also severely impaired by **ageing**, even if the tread is still much deeper than 4 mm.

A code letter indicating the speed limit is stamped on all winter tyres»» page 304.

Vehicles capable of exceeding these speeds must have an appropriate **sticker** attached so that it is visible to the driver. Suitable stickers are available at specialised CUPRA Services, SEAT Official Service centres and specialised workshops. Please note the regulations to this effect in your country.

“All-weather” tyres can also be used instead of winter tyres.

### Using winter tyres with V-rating

Please note that the generally applicable 240 km/h (149 mph) speed for winter tyres with the letter V is subject to **technical restrictions; the maximum permissible speed for your vehicle may be significantly lower**. The maximum speed limit for these tyres depends directly on the maximum axle weights for your car and on the listed weight rating of the tyres being used.

It is best to contact a specialised CUPRA Service or SEAT Official Service to check the maximum speed which is permissible for the V-rated tyres fitted on your car on the basis of this information.

#### WARNING

**Exceeding the maximum speed permitted for the winter tyres fitted on your car can cause tyre failure, resulting in a loss of control of the vehicle – risk of accident.**

#### For the sake of the environment

**When winter is over, change back to summer tyres at an appropriate moment. In temperatures above +7°C (+45°F), performance will be improved if summer tyres are used. Fuel consumption, wear and noises while driving will all be reduced.**

### Snow chains

Snow chains must only be fitted **to the front wheels**, even on vehicles with **four-wheel drive**.

- Check that they are correctly seated after driving for a few yards; correct the position if necessary, in accordance with the manufacturer's fitting instructions.
- Keep your speed below 50 km/h (30 mph).
- If there is a danger of being trapped despite having mounted the chains, it is best to disable the driving wheels (ASR) in the ESC »» page 251, Connecting and disconnecting the ESC.

Snow chains will improve *braking ability* as well as *traction* in winter conditions.

For technical reasons snow chains may only be used with the following wheel rim/tyre combination.

Tyres	Wheel rim	Chains
225/50 R18	7Jx18 VAS 45	Max. link 9 mm
225/45 R19	8Jx19 VAS 45	
Other dimensions do not allow chains		

<sup>1)</sup> COC = certificate of conformity.

Remove any central wheel trims before fitting snow chains.

#### ⚠ WARNING

The use of unsuitable or incorrectly fitted chains could lead to serious accidents and damage.

- Always the appropriate snow chains.
- Observe the fitting instructions provided by the snow chain manufacturer.
- Never exceed the maximum permitted speeds when driving with snow chains.

#### ⓘ CAUTION

- Remove the snow chains to drive on roads without snow. Otherwise they will impair vehicle handling, damage the tyres and wear out very quickly.
- Wheel rims may be damaged or scratched if the chains come into direct contact with them. CUPRA recommends the use of coated snow chains.

## Tyre pressure monitor system

### Control lamp

#### ⓘ It lights up

The inflation pressure of one or more wheels is much lower than the value set by the driver, or the tyre has structural damage.

In addition, an audible warning sounds and a text message is displayed on the instrument panel screen.

**🛑 Stop the vehicle!** Stop the vehicle safely as soon as possible. Check all tyres and pressures. Replace any damaged tyres.

#### ⓘ Flashes

System fault

The control lamp flashes for approximately 1 minute and then lights up permanently.

If the tyre is inflated correctly, switch the ignition off and on again. Re-calibrate the tyre pressure monitor indicator» page 311. If the fault continues, go to a specialised workshop.

Several control and warning lamps light up for a few seconds when the ignition is switched on while the function is verified. They will switch off after a few seconds.

#### ⚠ WARNING

Observe the safety warnings » ⚠ in Control and warning lamps on page 81.

## Tyre pressure monitor indicator

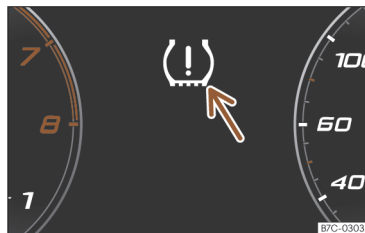

Fig. 207 Instrument panel: warning of loss of tyre pressure.

The tyre pressure monitoring system compares the individual speeds of each wheel and thus the dynamic radius with the help of the ABS sensors.

If the rolling circumference of one or more wheels has changed, the tyre pressure monitoring indicator will indicate this on the instrument panel through a warning lamp and a warning to the driver» Fig. 207. When only one specific tyre is affected, its position within the vehicle will be indicated.

ⓘ **Loss of pressure: Check left tyre pressure!**

### Wheel tread change

The wheel diameter changes when:

- Tyre pressure is changed manually.



- Tyre pressure is insufficient.
- The tyre structure is damaged.
- The vehicle is unbalanced because of a load.
- The wheels on an axle are subject to a heavier load (e.g. with a heavy load).
- The vehicle is fitted with snow chains.
- The temporary spare wheel is fitted.
- The wheel on one axle is changed.

There may be a delay in the reaction of the tyre pressure monitoring indicator (⚠) or it may not indicate anything under certain circumstances (e.g. sporty driving, snow-covered or unpaved roads, or when driving with snow chains).

### Calibrate the tyre pressure monitoring indicator

After changing the tyre pressure or replacing one or more wheels, the tyre pressure monitoring indicator must be recalibrated. Do the same, for example, when the front and rear wheels are swapped.

- Switch the ignition on.
- Save the new inflation pressure in the Infotainment system: function button  > **Vehicle status** > **Tyres**»» page 85 .

When driving, the system self-calibrates the tyre pressure provided by the driver and the

wheels fitted. After a long journey with varied speeds the programmed values are collected and monitored.

With the wheels under very heavy loads, the tyre pressure must be increased to the total recommended tyre pressure before calibration»» **Fig. 204** .

### WARNING

When the tyres are inflated at different pressures or at a pressure that is too low then a tyre may be damaged resulting in a loss of control of the vehicle and a serious or fatal accident.

- If the lamp (⚠) lights up, reduce speed immediately and avoid any sudden turning or braking manoeuvre. Stop when possible, and check the tyre pressure and status.
- The tyre pressure monitoring system can only operate correctly if all of the tyres are inflated to the correct pressure when cold.
- If a tyre has not been punctured and it does not have to be changed immediately, drive to the nearest specialised workshop at a moderate speed and have the tyre checked and inflated to the correct pressure.

### Note

- Driving for the first time with new tyres at a high speed can cause them to slightly expand, which could then produce an air pressure warning.

- If excessively low tyre pressure is detected with the ignition on, an audible warning will sound. In the event that there is a fault in the system, an audible warning will sound.

- Driving on dirt tracks for a long period of time or driving in a sporty style can temporarily deactivate the TPMS. The control lamp shows a fault, but disappears when road conditions or the driving style change.

- Do not only rely on the tyre pressure monitoring system. Regularly check your tyres to ensure that the tyre pressure is correct and that the tyres are not damaged due to puncture, cuts, tears and impacts/dents. Remove objects from the tyres only when they have not pierced the tyres.

- The tyre pressure monitoring indicator does not function when there is a fault in the ESC or ABS»» page 250 .

## Spare wheel

### Location and use of the temporary spare wheel

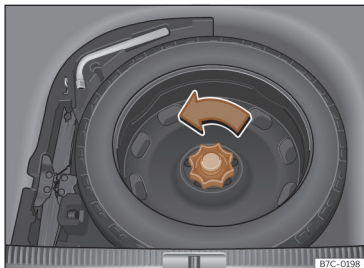

**Fig. 208** In the luggage compartment: load floor raised.

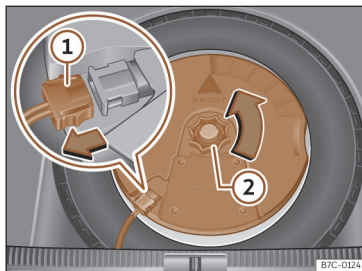

**Fig. 209** In the luggage compartment: remove the subwoofer.

The temporary spare wheel is stored under the floor panel in the luggage compartment and is attached by a thumbnut.

The temporary spare wheel has been designed to be used for short periods of time. Have the tyre checked and replaced as soon as possible at a specialised CUPRA Service, SEAT Official Service or at a specialised workshop.

The spare wheel must not be switched for a spare wheel from another vehicle.

#### Removing the temporary spare wheel

- Lift and hold up the floor panel to remove the temporary spare wheel»» page 132 .
- Turn the thumb wheel anti-clockwise »» **Fig. 208**.

- Take out the temporary spare wheel.

#### Getting the spare wheel out of vehicles with BEATS Audio 10 speakers (with subwoofer)

To remove the spare wheel, you must first remove the subwoofer.

- Lift and secure the luggage compartment floor as described in»» page 132 .
- Disconnect the *subwoofer*»» **Fig. 209** ① speaker cable.
- Turn the securing wheel in an anti-clockwise direction»» **Fig. 209** ②.
- Remove the *subwoofer* speaker and the spare wheel.
- When re-mounting the spare tyre, place the *subwoofer* on the base of the wheel rim with care. When doing so, the tip of the “FRONT” arrow on the *subwoofer* should point forward.
- Reconnect the speaker cable and firmly rotate the securing wheel clockwise so that the *subwoofer* system and wheel are firmly in place.

#### Chains

For technical reasons, snow chains must not be used on the temporary spare wheel.

If you have a puncture on one of the front wheels when using snow chains, fit the temporary spare wheel in place of one of the

rear wheels. Fit the snow chains on the rear wheel that you have removed and replace the punctured front wheel with this wheel.

### WARNING

- After fitting the temporary spare wheel, check the tyre pressures as soon as possible. Failure to do so may cause an accident. The tyre pressure is listed on the back of the left front door frame»» Fig. 204.
- Do not drive at over 80 km/h (50 mph) when the temporary spare wheel is fitted on the vehicle: risk of accident!
- Never travel more than 200 km using a temporary spare wheel.
- Avoid heavy acceleration, hard braking and fast cornering: risk of accident!
- Never use more than one temporary spare wheel at the same time, risk of accident.
- No other type of tyre (normal summer or winter tyre) may be fitted on the compact temporary spare wheel rim.
- If you are driving using the spare wheel, the ACC system could automatically switch off during the journey. Switch off the system when starting off.

# Maintenance

## Service

### Service intervals

#### Service work and the Digital Maintenance Plan

##### Log of services performed (“Digital Maintenance Plan”)

Specialised CUPRA dealers, SEAT dealerships or a specialised workshop records Service receipts in a central system. Thanks to this comprehensive documentation of the service history, it is possible to reproduce the services performed any time. CUPRA recommends requesting a Service receipt after every service carried out containing all the services carried out on the system.

Whenever there is a new service the receipt is replaced with a current one.

**The Digital Maintenance Plan is not available in some markets. In this case, your specialised CUPRA dealer or a SEAT dealership will inform you about the current documentation of the work.**

##### Service works

In the Digital Maintenance Plan, your specialised CUPRA dealer, SEAT dealership or a specialised workshop will document the following information:

- When each one of the services was carried out.
- Whether a specific repair has been suggested, e.g. changing the brake pads in the near future.
- If you have expressed a special request for the maintenance. Your Service Advisor will write the work order.
- The components or fluids that were changed.
- The date of the next service.

The Long Life Mobility Warranty is valid until the next inspection. This information is documented in all checks performed.

The type and the volume of the service may vary from one vehicle to another. A specialised workshop will be able to provide specific information on the jobs for your vehicle.

#### WARNING

**If the services are insufficient or not performed and if the service intervals are not observed, the vehicle may be immobilised in traffic cause an accident and severe injuries.**

- **Make sure that any repairs are carried out by a specialised CUPRA dealer, a SEAT dealership or a specialised workshop.**

#### CAUTION

**CUPRA cannot be held liable for any damage to the vehicle due to insufficient work or of lack of availability of spare parts.**

#### Note

**Regular services on the vehicle not only maintain its value, but also its correct operation and road safety. For this reason, conduct the services in accordance with CUPRA guidelines.**

#### Set Service or Flexible Service Intervals

Services are classified as **oil change service** and **inspection**. The service interval display on the instrument panel display serves as a reminder of the next service.

Depending on the features, the engine and the conditions of use of the car, either the **Fixed service** or the **Flexible service** will be applied for an oil change service..

## How to know which type of service needs to his vehicle

- Check the tables below:

Oil change service <sup>a)</sup>		
PR No.	Type of service	Service interval
QJ1	Fixed	Every 5000 km or after 1 year <sup>b)</sup>
QJ2		Every 7500 km or after 1 year <sup>b)</sup>
QJ3		Every 10000 km or after 1 year <sup>b)</sup>
QJ4		Every 15000 km or after 1 year <sup>b)</sup>
QJ6	Flexible	According to the service interval display

<sup>a)</sup> The data are based on normal conditions of use.

<sup>b)</sup> Whatever happens first.

### Inspection Service<sup>a)</sup>

According to the service interval display

<sup>a)</sup> The data are based on normal conditions of use.

## Particular characteristics of the Flexible Service

Regarding the **Flexible Service**, the oil change service only has to be performed when the vehicle needs it. To calculate when

you have to carry out this service, take into account the individual conditions of use and personal driving style. A major component of the flexible service the use of LongLife oil instead of conventional engine oil.

Bear in mind the information about the specifications of the engine oil according to the VW standard»» page 292.

**If you do not want to the flexible service you can select the fixed service However, a fixed service may affect service costs** The Service Advisor will gladly advise you.

### Service interval display

At CUPRA, the dates of the services are indicated by the service interval display on the instrument panel»» page 77 or in the **Vehicle settings** menu of the infotainment system»» page 82.

The service interval display gives information for service dates that involve an engine oil change or an inspection. When the time for the corresponding service comes, additional work required, such as the change of brake fluid and the spark plugs, can be carried out.

## Information about the terms of use

The service intervals and groups are usually based on **normal conditions of use**.

If, on the other hand, the vehicle is under **adverse conditions of use**, some of the work must be carried out before the next service period or even between service intervals.

### Conditions of use adverse include:

- The use of fuel with a high sulphur content.
- Frequent short trips.
- Letting the engine idle for a long period of time, as in the case of taxis.
- Using the vehicle in areas with thick dust.
- Frequent driving with a trailer (depending on equipment).
- Using the vehicle mostly in situations with a lot of traffic and stops (e.g. in a city).
- Using the vehicle mostly in winter.

### This applies especially for the following parts (depending on equipment):

- Dust and pollen filter
- Air Care allergen filter
- Air filter
- Toothed chain
- Particulate filter
- Engine oil

**The Service Advisor of your specialised workshop will gladly inform you about the** »

need of performing service work between normal service intervals, always considering the conditions of use of your vehicle.

### WARNING

If the services are insufficient or not performed and if the service intervals are not observed, the vehicle may be immobilised in traffic and cause accidents and severe injuries.

- Make sure that any repairs are carried out by a specialised CUPRA dealer, a SEAT dealership or a specialised workshop.

### CAUTION

CUPRA cannot be held liable for any damage to the vehicle due to insufficient work or of lack of availability of spare parts.

## Service sets

Sets of services include all the **maintenance works** needed to ensure the safety and the smooth running of the vehicle (**depending on the conditions of use and the features of the vehicle**, such as the engine, gearbox, or operating fluids). Maintenance services are divided into *inspection* and *review* services. Consult the details of the jobs required for your vehicle at:

- Your CUPRA dealer

- Your SEAT dealership
- Your specialised workshop

Due to technical reasons (continuous development of components) the sets of services may vary. Your specialised CUPRA dealer, any SEAT dealership or a specialised workshop always receives updated information about any modifications that are made.

## Additional service offers

### Approved spare parts

Original SEAT Spare Parts have been conceived for their vehicles and approved by SEAT, with a special emphasis on safety. These parts correspond exactly to the manufacturer's requirements in terms of design, accuracy of the measurements and materials. The original SEAT Spare Parts have been conceived exclusively for your vehicle. For this reason, we always recommend the use of Original SEAT Spare Parts. SEAT cannot be held liable for the safety and suitability of parts from other manufacturers.

### Approved spare parts

Approved spare parts, following the manufacturer's requirements, are an additional

service to you, offering the possibility of replacing complete sets, such as: light engine, gearboxes, heads, control units, electrical components, etc.

These parts are, **approved parts**, and are the same as the factory parts, which are also approved spare parts.

## Original accessories

We recommend you only use CUPRA Original Accessories and CUPRA approved accessories for your vehicle. The reliability, safety and suitability of these accessories have been inspected specifically for this type of vehicle. CUPRA cannot be held liable for the safety and suitability of parts from other manufacturers.

## Mobility Service (Service Mobility)

Since the moment you purchase your CUPRA vehicle you will be able to enjoy the benefits and coverage of the CUPRA Mobility Service.

For the first two years after the purchase, your new CUPRA vehicle is automatically covered by the CUPRA Mobility Service without additional costs.

If you wish to enjoy this service after this period, you can extend the Mobility Service as long as you carry out the recommended Inspection and Maintenance Services at a specialised CUPRA Service or SEAT Official Service.

If your CUPRA vehicle is immobilised due to a fault or an accident, our assistance services will help you keep moving.

Take into account that the Mobility Service differs depending on the country where the vehicle was purchased. For further information, ask your specialised CUPRA dealer, any SEAT dealership or visit the CUPRA website in your country.

## Warranty

### Fault-free operation warranty

Specialised CUPRA Services or SEAT Official Services ensure the perfect condition of new vehicles. Check the purchase agreement or complementary additional documentation provided by your Technical Service to see the conditions and the terms of the warranty. Consult further information in this regard in your specialised CUPRA Service or SEAT Official Service.

## Vehicle maintenance

### Maintenance and cleaning

#### Basic observations

Regular and careful care helps to maintain the value of your vehicle. In addition, it may become a prerequisite to demand the warranty in the event of corrosion damage and deficiencies in the paint coat of the bodywork.

Specialised workshops have the necessary care products. Please follow the instructions for application on the packaging.

#### WARNING

- Cleaning products and other materials used for car care can be damaging to your health if misused.
- Always keep care products in a safe place, out of the reach of children. Danger of poisoning!

#### For the sake of the environment

- When purchasing car care products, chose products that are compatible with the environment.
- The waste from car-care products should not be disposed of with ordinary household waste.

### Washing the vehicle

The longer you take to clean the tanks, e.g. remains of insects, bird excrements, tree resin or anti frost salt adhered to your vehicle, the more damage it can cause to the surface. High temperatures, for instance strong sunlight, further intensify the damage.

Before washing the car, soften the dirt using plenty of water.

To remove encrusted dirt such as insects, bird droppings or tree resin, use a lot of water and a microfibre cloth.

Have the underside of the vehicle washed after the end of the anti frost salts in winter.

#### High pressure cleaning equipment

When washing the vehicle with a high-pressure cleaner, always follow the operating instructions for the equipment. This applies particularly to the operating pressure and the distance between the spraying water. Do not aim the jet directly to the side window gaskets, doors, covers or the panoramic sunroof; the same applies to tyres, rubber hoses, soundproofing material, sensors or camera lenses. Keep a distance of at least 40 cm.

Do not remove snow and ice with a high-pressure cleaner.



Do not use a nozzle that sprays the water out in a direct stream or one that has a rotating jet for forcing off dirt.

The water temperature must not exceed 60°C.

### Automatic car washes

Spray the vehicle before starting the car wash.

Make sure that the windows and the panoramic sunroof are closed and the windscreen wipers are deactivated. Bear in mind the instructions of the car wash tunnel operator, especially if your vehicle has detachable parts.

Use of car washes without brushes if possible.

### Washing by hand

Clean your vehicle from top to bottom with a soft sponge or with a brush. Only use cleaning products that do not contain solvents.

### Washing vehicles with a matte paint by hand

To prevent damage to the vehicle when washing it, first remove the thicker dust and dirt. To remove traces of insects, grease and fingerprints, it is best to use a special cleaner for matte paint.

Apply the product with a microfibre cloth. To avoid damaging the surface of the paint, do not apply too much pressure.

Rinse with plenty of water. Then clean it with a neutral cleaning product and a soft microfibre cloth.

Rinse the vehicle again with plenty of water and then leave it to dry. Remove traces of water with a leather cloth.

### WARNING

- Only wash the vehicle with the ignition switched off or according to the specifications of the car wash tunnel operator. Risk of accident!
- When cleaning the underbody or the inside of the wheel arches, protect yourself from sharp or pointy metal parts. Risk of cut!
- After cleaning the brakes could act more slowly due to moisture or, in winter, the ice on the brake discs and pads. Risk of accident! In this case the brakes should be dried by pressing the brake pedal several times.

### CAUTION

- Before washing the vehicle in an automatic car wash, please make sure to retract the exterior mirrors to prevent them from being damaged. Electric exterior rearview

mirrors must always be folded/deployed electrically!

- Do not wash the vehicle in direct sunlight. Risk of damaging the paint job!
- Do not use sponges, abrasive household sponges or similar to clean insect remains. Risk of damaging the surface!
- Vehicle parts with matte paint:
  - Do not use polish or hard wax. Risk of damaging the surface!
  - Never select washing programs that include the use of wax. This could damage the appearance of matte paint.
  - Do not put stickers or magnets on parts with matte paint, as removing them may damage the paint.

### For the sake of the environment

The car should only be washed in special wash bays. These places are prepared to prevent oily water from getting into the public drains.

### Cleaning and maintenance instructions

The cleaning and maintenance of individual components of the vehicle can be checked in the following tables. The contents should be understood merely as a recommendation. Go to your specialised workshop if you



have special questions or parts that are not listed. Take the general considerations into account >>> **△** in Take special care with... on page 322.

### Cleaning the exterior

#### Windscreen wipers

Problem	Solution
Dirt	Soft cloth with wipers

#### Headlights / Tail lights

Problem	Solution
Dirt	Soft sponge with neutral soap solution <sup>a)</sup>

<sup>a)</sup> Neutral soap solution: two tablespoons maximum in 1 litre of water

#### Sensors / Camera lenses

Problem	Solution
Dirt	<i>Sensors:</i> soft cloth with a solvent-free cleaning product <i>Camera lenses:</i> soft cloth with an alcohol-free cleaning product
Snow/ice	Hand brush/Anti frost spray with no solvents

#### Wheels

Problem	Solution
Antifreeze salt	Water
Brake abrasion dust	Acid-free special cleaning product

#### End exhausts

Problem	Solution
Antifreeze salt	Water, if a steel cleaning product is required

#### Covers / Trims

Problem	Solution
Dirt	Neutral soap solution <sup>a)</sup> , if a steel cleaning product is required

<sup>a)</sup> Neutral soap solution: two tablespoons maximum in 1 litre of water

#### Paint

Problem	Solution
Paint flaws	Check the paint's colour code in an authorised service and re-store with a touch-up pencil
Spilled fuel	Immediately rinse with water
Environmental rust tank	Apply rust remover and then apply hard wax. Go to your specialised workshop if you have any queries

Problem	Solution
Corrosion	Have your specialised workshop take care of this
The water does not create droplets on the clean paint	Maintain with hard wax (at least 2 times a year)
No shine despite sober maintenance/paint	Treat with suitable wax and apply paint preservative afterwards if the wax used does not contain preservative ingredients
Tanks, e.g. insect remains, bird droppings, tree sap, road salt	Immediately soften with water and remove with a microfibre cloth
Fat-based dirt, e.g. cosmetic products or sunscreen	Delete immediately with a neutral soap solution <sup>a)</sup> and a soft cloth

<sup>a)</sup> Neutral soap solution: two tablespoons maximum in 1 litre of water

#### Carbon fibre parts

Problem	Solution
Dirt	Clean the same way as painted parts >>> page 317 <b>»</b>

## Decoration slides

Problem	Solution
Dirt	Soft sponge with neutral soap solution <sup>a)</sup>

<sup>a)</sup> Neutral soap solution: two tablespoons maximum in 1 litre of water

## Interior cleaning

### Windows

Problem	Solution
Dirt	Apply windscreen cleaner and then dry with a cloth

### Covers / Trims

Problem	Solution
Dirt	Neutral soap solution <sup>a)</sup>

<sup>a)</sup> Neutral soap solution: two tablespoons maximum in 1 litre of water

### Plastic parts

Problem	Solution
Dirt	Damp cloth
Encrusted dirt	Neutral soap solution <sup>a)</sup> , if possible solvent-free plastic cleaner

<sup>a)</sup> Neutral soap solution: two tablespoons maximum in 1 litre of water

## Displays/instrument panel

Problem	Solution
Dirt	Soft cloth with a liquid crystal display cleaner

## Control panels

Problem	Solution
Dirt	Soft brush, then soft cloth with neutral soap solution <sup>a)</sup>

<sup>a)</sup> Neutral soap solution: two tablespoons maximum in 1 litre of water

## Seat belts

Problem	Solution
Dirt	Neutral soap solution <sup>a)</sup> , allowed to dry before retracting

<sup>a)</sup> Neutral soap solution: two tablespoons maximum in 1 litre of water

## Fabrics, artificial, Alcantara leather

Problem	Solution
Particles of dirt stuck to surfaces	Vacuum cleaner
Water-based dirt, e.g. coffee, tea, blood etc.	Absorbent cloth and neutral soap solution <sup>a)</sup>

Problem	Solution
Grease-based dirt, e.g. oil, make-up, etc.	Apply a neutral soap solution <sup>a)</sup> . Absorb the dissolved grease and paint particles drying with an absorbent cloth, in case you must treat it with water afterwards
Special dirt, e.g. pens, nail polish, dispersion paint, shoe cream etc.	Special stain remove: dry with an absorbent cloth, if applicable, apply neutral soap solution afterwards <sup>a)</sup>

<sup>a)</sup> Neutral soap solution: two tablespoons maximum in 1 litre of water

## Natural leather

Problem	Solution
Recent dirt	Cotton cloth with neutral soap solution <sup>a)</sup>
Water-based dirt, e.g. coffee, tea, blood etc.	Recent stains: absorbent cloth Dry stains: stain remover suitable for leather
Grease-based dirt, e.g. oil, make-up, etc.	Recent stains: absorbent cloth and suitable stain remover for leather Dry stains: grease solvent spray
Special dirt, e.g. pens, nail polish, dispersion paint, shoe cream etc.	Stain remover suitable for leather

Problem	Solution
Care	Apply preservative cream regularly to protect from sunlight. Use a colour preservative if required

a) Neutral soap solution: two tablespoons maximum in 1 litre of water

### Carbon fibre parts

Problem	Solution
Dirt	Clean like plastic parts

### Take special care with...

#### Headlights/tail lights

- Do not clean the headlights/tail lights with a dry cloth or sponge.
- Do not use cleaning products that contain alcohol. Risk of cracks!

#### Wheels

- Do not use for paint wax or other abrasive products.
- If the protective coating on the paint of the rim has been damaged due to stone impacts, scratches, etc., the damage should be repaired immediately.

#### Camera lenses

- Do not use hot or warm water to remove ice or snow from the camera lenses. Risk of cracking the lens!
- To clean the camera lens, never use abrasive cleaning products or products with alcohol. Risk of scratches and cracks!

#### Windows

- Remove snow and ice from windows and exterior mirrors with a plastic scraper only. To avoid scratches, the scraper should only be pushed in one direction and not moved to and fro.
- Never remove snow or ice from windows and rearview mirrors with warm or hot water. Risk of cracks on the windows!
- To prevent damage to the heating of the rear window, do not put stickers over the heating elements.

#### Covers/trims

- Do not use cleaning products or chrome based cleaning agents.

#### Paint

- The vehicle must be free from dirt and dust before applying wax or care products. Risk of scratches!
- Do not apply wax or care products if the vehicle is exposed to direct sunlight. Risk of damaging the paint job!

- The ambient rust deposits must not be removed through friction. Risk of damaging the paint job!
- Remove cosmetic products and sunlight immediately. Risk of damaging the paint job!

#### Displays/instrument panel

- The screens, the instrument panel and the trim around it must not be cleaned dry. Risk of scratches!
- Make sure that the instrument panel is switched off and cooled down before cleaning.
- Make sure that no liquid leaks between the instrument panel and the trim. Risk of damage!

#### Control panels

- Make sure that no liquid leaks into the control panels. Risk of damage!

#### Seat belts

- Do not remove the seat belts to clean them.
- Seat belts and their components must never be cleaned with chemical products, nor should they be allowed to come into contact with corrosive liquids, solvents or sharp objects. Risk of damaging the fabric!
- If you find any damage to the belt webbing, belt fittings, the belt retractor or the buckle, ask your specialised workshop to replace the belt in question.



### Fabrics/artificial leather/Alcantara leather

- Do not treat artificial leather/Alcantara with leather cleaning products, solvents, wax polish, shoe cream, stain removers or similar products.
- If the stain is very hard to remove, take the vehicle to a specialised workshop to have it removed there. This will prevent damage.
- Do not use steam cleaners, brushes, hard sponges, etc. to clean.
- Do not turn on seat heating to dry the seats.
- Sharp objects on clothing, such as zips, rivets or belts can damage the surface.
- Open Velcro, e.g. on clothes can damage the seat upholstery. Make sure that Velcro fasteners are closed.

### Natural leather

- Never use solvents, wax polish, shoe cream, spot removers or similar products on leather.
- Sharp objects on clothing, such as zips, rivets or belts can damage the surface.
- Do not use steam cleaners, brushes, hard sponges, etc. to clean.
- Do not turn on seat heating to dry the seats.
- Avoid exposing leather to direct sunlight for long periods, otherwise it may tend to

lose some of its colour. If the car is left for a prolonged period in the bright sun, it is best to cover the leather.

#### WARNING

Do not use water-repellent coatings on the windscreen. In bad visibility conditions such as humid weather, darkness or when the sun is in its lowest point, visibility may be impacted. Risk of accident! Such coatings can also cause the windscreen wiper blades to make noise.

#### Note

- Remains of insects can be removed much more easily with previously treated paint.
- Regular car care treatments can prevent deposits of ambient rust.

### Remove the vehicle from traffic

If you want to leave your vehicle stationary for a long period of time, contact a qualified workshop. They will gladly inform you about the necessary measures, such as anti-corrosion protection, Service and storage.

Also take into account the indications relating to the vehicle's battery»»» page 299, 12-volt battery.

## Accessories and modifications to the vehicle

### Accessories, spare parts and repair work

#### Introduction

Always ask your dealer or specialist retailer for advice before purchasing accessories and replacement parts.

Your vehicle is designed to offer a high standard of active and passive safety. For this reason, we recommend that you ask a specialised CUPRA Service or SEAT Official Service for advice before fitting accessories or replacement parts. Your Official Service has the latest information from the manufacturer and can recommend accessories and replacement parts which are suitable for your requirements. They can also answer any questions you might have regarding official regulations.

We recommend you to use only **CUPRA accessories** and **Genuine CUPRA parts**®. Specialised CUPRA Services or SEAT Official Services have the necessary experience and facilities to ensure that the parts are installed correctly and professionally.

Any **retro-fitted equipment** which has a direct effect on the vehicle and/or the way it is driven, such as a cruise control system or **electronically-controlled suspension**, must be approved for use in your vehicle and bear the **e** mark (the European Union's authorisation symbol).

If **any additional electrical devices** are fitted which do not serve to control the vehicle itself (for instance a refrigerator box, laptop or ventilator fan, etc.), they must bear the **CE** sign (manufacturer conformity declaration in the European Union).

### WARNING

Accessories, for example telephone holders or cup holders, should never be fitted on the covers, or within the working range of the airbags. Otherwise, there is a danger of injury if the airbag is triggered in an accident.

### Technical modifications

Modifications must always be carried out according to our specifications.

Unauthorised modifications to the electronic components, software, wiring or data transfer in the vehicle may cause malfunctioning. Due to the way the electronic components are linked together in networks, other indirect systems may be affected by

the faults. This can seriously impair safety, lead to excessive wear of components, and also invalidate your vehicle registration documents.

You will appreciate that your specialised CUPRA dealer or SEAT dealership cannot be held liable for any damage caused by modifications and/or work performed incorrectly in the vehicle.

We therefore recommend that all work should be performed by a specialised CUPRA Service or a SEAT Official Service using **genuine CUPRA® parts**.

### WARNING

Incorrectly performed modifications or other work on your vehicle can lead to malfunctions and cause accidents.

### Radio telephones and office equipment

#### Radio transmitters (fixed installation)

Any retrofit installations of radio transmitters in the vehicle require prior approval. CUPRA generally authorises in-vehicle installations of approved types of radio transmitters provided that:

- The antenna is installed correctly.

- The aerial is installed on the exterior of the vehicle (and shielded cables are used together with non-reflective aerial trimming).
- The effective transmitting power does not exceed 10 Watts at the aerial base.

A specialised CUPRA Service, SEAT Official Service or specialised workshop will be able to inform you about options for installing and operating radio transmitters with a *higher* transmitting power.

#### Mobile radio transmitters

Commercial mobile telephones or radio equipment might interfere with the electronics of your vehicle and cause malfunctions. This may be due to:

- No external aerial.
- External aerial incorrectly installed.
- Transmitting power more than 10 W.

You must, therefore, do not operate portable mobile telephones or radio equipment *inside the vehicle* without a properly installed external aerial »» .

Please note also that the maximum range of the equipment can only be achieved with an *external* aerial.

#### Business equipment

Retrofit installation of business or private equipment in the vehicle is permitted, »

provided the equipment cannot interfere with the driver's immediate control of the vehicle and that any such equipment carries the **CE** mark. Any retrofit equipment that could influence the driver's control of the vehicle must have a type approval for your vehicle and must carry the **e** mark.

### **WARNING**

Mobile telephones or radio equipment which is operated inside the vehicle without a properly installed external aerial can create excessive magnetic fields that could cause a health hazard.

### **Note**

- The posterior fitting of electric and electronic equipment in this vehicle affects its licence and could lead to the withdrawal of the vehicle registration document under certain circumstances.
- Please use the mobile telephone/radio operating instructions.

## Information for the user

### Information for the user

### Information stored by the control units

#### Storage of accident data (Event Data Recorder)

Your vehicle has an event data recorder (EDR).

The EDR's function is to record data in the event of a mild or serious accident. These data are used to support the analysis of how different vehicle systems behaved.

The EDR records, over a reduced time range (normally 10 seconds or less), dynamic driving data and data from the restraint systems, such as:

- How different vehicle systems worked.
- Whether the driver and the occupants were wearing their seat belts.
- How hard the acceleration or brake pedal was pressed.
- Vehicle speed.

These data will provide a better understanding of the circumstances of the accident.

Data from the driving assist systems are also recorded. This includes data such as whether the systems were inactive or active and if such action had an impact on the vehicle's dynamic behaviour, changing its path in the aforementioned situations, accelerating or decelerating the vehicle.

Depending on vehicle equipment, this includes data from systems such as:

- Adaptive Cruise Control (ACC)
- Emergency brake assistance system (Front Assist).
- Park Pilot system
- Parking aid system (Park Assist).
- Lane Assist

The EDR data are only recorded in specific accident situations. No data are recorded in normal driving conditions.

No audio or video data inside or around the vehicle are recorded. Under no circumstances are personal data such as name, age, or gender recorded. Nevertheless, third parties (such as criminal proceedings authorities) may relate the contents of the EDR data to other data sources and create a personal reference in the context of an accident investigation.

In order to read the EDR data it is necessary to access (if legally permitted to do so) the vehicle's ODB ("On-Board-Diagnose") interface while the vehicle is switched on.

CUPRA will not have access to EDR data unless the owner (or, in "Leasing" cases, the lessee or hirer) gives their consent. There may be exceptions to this, depending on legal or contractual provisions.

Due to legal requirements in safety-related products, CUPRA may use the EDR data for field research and in order to improve vehicle system quality. Any data used for the purposes of research will be treated anonymously (in other words, no reference will be made to the vehicle, their owner or the lessee/hirer).

## Other important information

### Environmental compatibility

Environmental protection is a top priority in the design, choice of materials and manufacture of your new CUPRA.

### Constructive measures to encourage recycling

- Joints and connections designed for easy dismantling. »

- Modular construction to facilitate dismantling.
- Increased use of single-grade materials.
- Plastic parts and elastomers are marked in accordance with ISO 1043, ISO 11469 and ISO 1629.

### Choice of materials

- Use of recycled materials.
- Use of compatible plastics in the same part if its components are not easily separated.
- Use of recycled materials and/or materials originating from renewable sources.
- Reduction of volatile components, including odour, in plastic materials.
- Use of CFC-free coolants.

**Ban on heavy metals, with the exceptions dictated by law (Annex II of ELV Directive 2000/53/EC):** cadmium, lead, mercury, hexavalent chromium.

### Manufacturing methods

- Reduction of the quantity of thinner in the protective wax for cavities.
- Use of plastic film as protection during vehicle transport.
- Use of solvent-free adhesives.
- Use of CFC-free coolants in cooling systems.

- Recycling and energy recovery from residues (RDF).
- Improvement in the quality of waste water.
- Use of systems for the recovery of residual heat (thermal recovery, enthalpy wheels, etc.).
- The use of water-soluble paints.

### Recycling of electrical or electronic devices

All electrical or electronic devices (EED) that are not permanently fitted in the vehicle must be marked with the following symbol:



This symbol indicates that EED must not be discarded as home waste but through selective waste collection.

## Information about the EU Directive 2014/53/EU

### Simplified EU compliance declaration

Your vehicle has different radioelectrical devices. The manufacturers of these devices

declare that they comply with Directive 2014/53/EU when legally required.

The full text of the EU compliance declaration is available online at the following address:

[www.cupraofficial.com](http://www.cupraofficial.com)



### Addresses of the manufacturers

According to the Directive 2014/53/EU, all relevant components must include the address of the manufacturer.

The address of the manufacturers of components that, due to their size or nature, cannot include a sticker are listed below, as long as it is legally required:

#### Central control unit (BCM)

Robert Bosch GmbH/Braunschweig  
Theodor-Heuss-Strasse 12  
38122 - Braunschweig, Germany  
Phone: 0049 53188890

#### Keyless Access system

HELLA GmbH & Co. KGaA/Hamm  
Roemerstr. 66  
59075 - Hamm, Germany  
Phone: 0049 23817980



### Roof antenna

ASK Industries S.p.A  
Via dell'Industria n.12/14/16  
60037 Monte San Vito (AN), Italy  
Phone: +3907174521  
Website: www.askgroup.it

Mitsumi Electronics Europe GmbH  
Siemensstrasse 32  
63225 Langen, Germany  
Phone: +49 (0) 6103913-0  
Website: www.minebeamitsumi.co.jp

Molex CVS Hildesheim GmbH  
Daimlerring 31  
31135 Hildesheim, Germany  
Phone: +49 3377 3160  
Website: www.molex.com

### Antenna amplifiers

ASK Industries S.p.A  
Via dell'Industria n.12/14/16  
60037 Monte San Vito (AN), Italy  
Phone: +3907174521  
Website: www.askgroup.it

Calearo Antenne S.P.A  
Corso Matteotti, 1  
20121 Milan, Italy  
Phone: +39 0444 90 13 11  
Website: www.calearo.com

Hirschmann Car Communication GmbH  
Stuttgarter Strasse 45-51  
72654 Neckartenzlingen, Germany  
Phone: +49 7127 140  
Website: www.te.com

KATHREIN Automotive GmbH  
Römerring 1  
31137 Hildesheim, Germany  
Phone: +498031184-0  
Website: www.kathrein.com

Molex CVS Hildesheim GmbH  
Daimlerring 31  
31135 Hildesheim, Germany  
Phone: +49 3377 3160  
Website: www.molex.com

### Navigation antenna

Hirschmann Car Communication GmbH  
Stuttgarter Strasse 45-51  
72654 Neckartenzlingen, Germany  
Phone: +49 7127 140  
Website: www.te.com

KATHREIN Automotive GmbH  
Römerring 1  
31137 Hildesheim, Germany  
Phone: +498031184-0  
Website: www.kathrein.com

### Connectivity Box

Molex CVS Dabendorf GmbH  
Märkische Strasse 72  
15806 Zossen OT Dabendorf, Germany  
Phone: +49 3377 3160  
Website: www.molex.com

### Basic infotainment system

Panasonic Automotive Systems Czech  
U Panasonicu 266  
530 06, Pardubice, Czech Republic

### Optional infotainment system

LG Electronics Mława SP  
LG Electronics 7  
06 500, Mława

### Remote control key

Digades GmbH Digitales Und Ana/Zittau  
Äußere Weberstr. 20  
02763 - Zittau, Germany  
Phone: 0049 358357750

### Instrument panel

Analogue SE38x/SE316  
Visteon Electronics Germany GmbH  
Visteonstr. 4-10  
50170 Kerpen, Germany



### Analogue all other models

Continental Automotive Spain, S.A.  
Ctra. de Rubí a Ullastrell, n° 12-30  
08191 Rubí (Barcelona - Spain)

### FPK (digital)

Continental Automotive GmbH  
VDO-Strasse 1,  
64832 Babenhausen, Germany

Panasonic Automotive Systems Europe GmbH  
Robert Bosch Str. 27-29  
63225 Langen, Germany

Panasonic Automotive Systems Czech, s.r.o.  
U Panasonicu 266  
530 06, Pardubice, Czech Republic

### Front radar sensors

*MRR for SE38X*  
Robert Bosch GmbH  
Markwiesenstrasse, 46  
72770 Reutlingen (Kusterdingen) Germany

*MRR for Tarraco, Ateca, Ibiza, Arona*  
Automotive Distance Control Systems GmbH  
Peter-Dornier-Strasse, 10  
88131, Lindau, Germany

### Rear radar sensors

Hella GmbH & Co. KGaA  
Rixbecker Straße 75  
59552 Lippstadt (Germany)

### Online Connectivity Unit

LG ELECTRONICS INC.  
10, Magokjungang 10-ro,  
Gangseo-gu, Seoul, Republic of Korea

## Frequency bands, station power

Radioelectrical equipment <sup>a)</sup>	Frequency band	Max. station power	Valid for models
Radiofrequency remote control (vehicle)	433.05-434.78 MHz	10 mW (ERP)	All CUPRA models
	433.05-434.79 MHz	10 mW	
	434.42 MHz	32 µW	
Radio frequency remote control (auxiliary heater)	868.7-869.2 MHz (869.0 MHz)	25 mW	Formentor
Transmitted-Receiver (independent heating)	868.7-869.2 MHz (869.0 MHz)	23.5 mW	Formentor
Bluetooth	2400-2483.5 MHz	10 dBm	All CUPRA models

## Information for the user

Radioelectrical equipment <sup>a)</sup>	Frequency band	Max. station power	Valid for models
Connection to the external antenna of the car	GSM 900: 880-915 MHz	33 dBm	Leon, Formentor, Born
	GSM 1800: 1710-1785 MHz	30 dBm	
	WCDMA FDD I: 1920-1980 MHz	21 dBm	
	WCDMA FDD III: 1710-1785 MHz	21 dBm	
	WCDMA FDD VIII: 880-915MHz	21 dBm	
	LTE FDD1: 1920-1980 MHz	23 dBm	
	LTE FDD3: 1710-1785 MHz	23 dBm	
	LTE FDD7: 2500-2570 MHz	23 dBm	
	LTE FDD8: 880-915 MHz	23 dBm	
	LTE FDD20: 832-862 MHz	23 dBm	
Auxiliary antenna for Car2X	5855-5925 MHz	2 W PIRE	Born
Wireless hotspot	2400-2483.5 MHz	10 dBm	All CUPRA models
Keyless Access	434.42 MHz	32 $\mu$ W	All CUPRA models
Radar sensors for assistance systems	76 GHz-77 GHz	28.2 dBm	Leon, Formentor
		35.0 dBm	Ateca
	24050-24250 MHz	20 dBm	Ateca
Wireless charging	110-120 kHz	5 W	Ateca, Leon, Formentor, Born
Instrument panel	125 kHz	40 dB $\mu$ A/m	All CUPRA models



## Information for the user

Radioelectrical equipment <sup>a)</sup>	Frequency band	Max. station power	Valid for models
Online Connectivity Unit	EGSM900: 880-915 MHz	33 dBm	All CUPRA models
	DCS1800: 1710-1785 MHz	31 dBm	
	UMTS FDD 1: 1920-1980 MHz	24 dBm	
	UMTS FDD 3: 1710-1785 MHz	24 dBm	
	UMTS FDD 8: 880-915 MHz	24 dBm	
	E-UTRA FDD 1: 1920-1980 MHz	23.5 dBm	
	E-UTRA FDD 3: 1710-1785 MHz	23.0 dBm	
	E-UTRA FDD 7: 2500-2570 MHz	23.5 dBm	
	E-UTRA FDD 8: 880-915 MHz	23.0 dBm	
	E-UTRA FDD 20: 832-862 MHz	23.5 dBm	
E-UTRA FDD 28: 703-748 MHz	23.0 dBm		

<sup>a)</sup> The commissioning or authorisation of radioelectrical technology may be restricted in some European countries, forbidden or only allowed with additional requirements.

Hereby, Molex CVS Dabendorf GmbH declares that the radio equipment type LTE-MBC-EU2 is in compliance with Directive 2014/53/EU. The full text of the EU declaration of conformity is available at the following internet address:

<http://www.molex.com/doc>

### Importer for United Kingdom market

#### The Radio Equipment Regulations 2017

This vehicle has various radio equipment devices installed.

The following acts as importer of the radio equipment devices for the United Kingdom market within the meaning of The Radio Equipment Regulations 2017:

**Volkswagen Group United Kingdom Ltd.**  
Yeomans Drive, Blakelands  
Milton Keynes, MK 14 5AN  
United Kingdom

# Technical data

## Indications about the technical data

### Important information

#### Introduction

The values indicated in the technical data may differ depending on optional equipment or version of the model, as well as in the case of special vehicles and equipment for certain countries.

The information in the official vehicle documentation takes precedence at all times.

#### Abbreviations used in the Technical Specifications section

kW	Kilowatt, engine power measurement.
PS	Pferdestärke (horsepower), formerly used to denote engine power.
rpm, 1/min	Revolutions per minute - engine speed.
Nm	Newton metres, unit of engine torque.
CZ	Cetane number, indication of the diesel combustion power.
RON	Research octane number, indication of the knock resistance of petrol.

#### Vehicle identification data

##### Vehicle ID number

The vehicle ID number can be found in the following places:

- One the vehicle's data label.
- In front, under the windscreen.
- To the right in the engine compartment.

##### Type plate

The type plate is located on the vehicle's right hand door frame. Vehicles for certain export countries do not have a type plate.

#### Fuel consumption

Approved consumption values are derived from measurements performed or supervised by certified EU laboratories, according to the legislation in force at the time (for more information, see the Publications Office of the European Union on the EUR-Lex website: © European Union, <http://eur-lex.europa.eu/>) and apply to the specified vehicle characteristics.

The values relating to fuel consumption and CO<sub>2</sub> emissions can be found in the documentation provided to the purchaser of the vehicle at the time of purchase.

Fuel consumption and CO<sub>2</sub> emissions depend on the equipment/features of each individual vehicle, as well as on the driving style, road conditions, traffic conditions, environmental conditions, load or number of passengers.

#### Filling capacities

##### Tank level

55l, 8.5l reserve

##### Capacity of the windscreen washer fluid container

approx. 3 litres

#### Weights

##### Load on the roof

The maximum authorised load on the roof of your vehicle is 75 kg.

##### Empty weight, total weight, axle loads

The empty weight of the vehicle with driver (75 kg) was calculated according to the (EU) 1230/2012 standard. Optional equipment can increase the empty weight, which means that the possible useful load decreases proportionally. »

### Trailer weight

The maximum permitted drawbar load on the ball head of the towing bracket is **88 kg**.

#### WARNING

The values indicated for the maximum permitted weights must not be exceeded.  
There is a risk of accident and damage!

## Engine specifications

	2.0 TSI Start-Stop
Power output in kW (PS) at 1/min	221 (300)/5,300-6,500
Maximum torque (Nm at 1/min)	400/2,000-5,200
No. of cylinders/displacement (cm <sup>3</sup> )	4/1,984
Fuel	Super 98 / Super 95 (with a slight power loss) ROZ
Gearbox	DSG 4Drive
Top speed (km/h)	249 (VI)
Acceleration from 0-100 km/h (seconds)	4.9
Maximum authorised weight (kg)	2,170

Dimensions

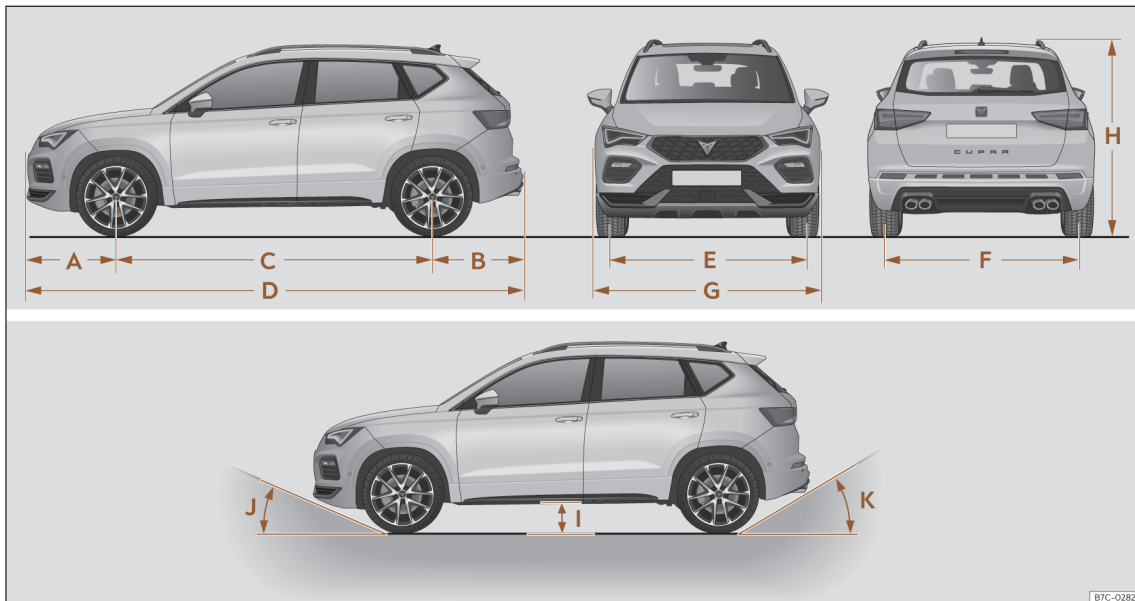

Fig. 210 Dimensions and angles.

B7C-0282



## Indications about the technical data

»» Fig. 210		Ateca 4Drive
A	Front projection (mm)	877
B	Rear projection (mm)	879
C	Wheelbase (mm)	2,630
D	Length (mm)	4,386
E	Front track (mm)	1,575
F	Back track (mm)	1,549
G	Width (mm)	1,841
H	Height at kerb weight (mm)	1,599 <sup>a)</sup> 1,613 <sup>b)</sup>
I	Ground clearance between the axles (mm)	160
J	Front projection angle limited by the bumper	maximum 19.3°
K	Rear projection angle limited by the bumper	maximum 23.5°
	Turning radius (m)	10.8

Values for the 245/40 R19 ET45 wheel and the 2.0 TSI 221 kw engine

a) Distance to the roof.

b) Dimension to the roof bars.



# Index

## Numbers and Symbols

### 12-volt battery

assisted start .....	50
charge level .....	301
charging .....	301
disconnect and connect .....	78, 299
electrolyte level .....	300
energy management .....	301
replacement .....	301
winter operations .....	299

4Drive .....	213
--------------	-----

## A

### ABS

see Anti-lock brake system .....	250
----------------------------------	-----

ACC .....	226
-----------	-----

Accessories .....	322
-------------------	-----

Activating CUPRA CONNECT .....	162
--------------------------------	-----

Adapting the playback volume .....	157
------------------------------------	-----

Adaptive Cruise Control .....	226
-------------------------------	-----

control and warning lamp .....	227
--------------------------------	-----

malfunction .....	231
-------------------	-----

noise .....	231
-------------	-----

operation .....	227
-----------------	-----

special driving situations .....	229
----------------------------------	-----

status display .....	229
----------------------	-----

### Adjust

front seats .....	123
-------------------	-----

headrest .....	125
----------------	-----

lights .....	117
--------------	-----

seats .....	13
-------------	----

seat with memory .....	126
------------------------	-----

time .....	75
------------	----

Adjusting the seat belt .....	20
-------------------------------	----

Airbags .....	23
---------------	----

activating and deactivating .....	27
-----------------------------------	----

description .....	24
-------------------	----

for the head .....	29
--------------------	----

for the knees .....	28
---------------------	----

front .....	26
-------------	----

side .....	28
------------	----

Airbag system .....	23
---------------------	----

activation .....	25
------------------	----

control lamp .....	25
--------------------	----

deactivation of the front airbag .....	27
--	----

description .....	24
-------------------	----

front airbags .....	25
---------------------	----

how it works .....	25
--------------------	----

### Air conditioning

air recirculation .....	146
-------------------------	-----

air vents .....	145
-----------------	-----

Climatronic .....	144
-------------------	-----

Air recirculation .....	146
-------------------------	-----

Air vents .....	145
-----------------	-----

### Alternator

warning lamp .....	300
--------------------	-----

### Android Auto™

Disconnecting .....	169
---------------------	-----

establish connection .....	168
----------------------------	-----

menu .....	168
------------	-----

requirements .....	168
--------------------	-----

special characteristics .....	169
-------------------------------	-----

Anti-lock brake system .....	250
------------------------------	-----

Anti-puncture .....	42, 43
---------------------	--------

Anti-puncture kit .....	41, 42
-------------------------	--------

check after 10 minutes .....	44
------------------------------	----

components .....	43
------------------	----

inflating the tyre .....	43
--------------------------	----

sealing the tyre .....	43
------------------------	----

Anti-puncture set .....	42
-------------------------	----

Anti-theft alarm system .....	97
-------------------------------	----

trailer .....	278
---------------	-----

### Anti-trap function

sunroof .....	110
---------------	-----

sunshade blind (glass roof) .....	110
-----------------------------------	-----

windows .....	107
---------------	-----

Antifreeze .....	295
------------------	-----

### Apple CarPlay

Disconnecting .....	168
---------------------	-----

establish connection .....	167
----------------------------	-----

menu .....	167
------------	-----

requirements .....	167
--------------------	-----

special characteristics .....	168
-------------------------------	-----

Applications (apps) .....	167
---------------------------	-----

### Aspects to think about before starting the vehicle

.....	12
-------	----

### ASR

see Traction control system .....	250
-----------------------------------	-----

### Assistance systems

adaptive cruise control .....	226
-------------------------------	-----

assisted parting system (Park Assist) .....	253
---	-----

Auto Hold function .....	248
--------------------------	-----

connecting .....	79
------------------	----

cruise control .....	220
----------------------	-----

disconnecting .....	79
---------------------	----

driver alert system .....	70
---------------------------	----

driving assist (Travel Assist) .....	236
--------------------------------------	-----

Emergency Assist .....	238
------------------------	-----

emergency braking (Front Assist) .....	223
--	-----

- front radar ..... 217  
 general notes ..... 216  
 hill descent control (HDC) ..... 208  
 lane departure warning (Side Assist) ..... 240  
 parking aid Plus ..... 261  
 peripheral view system (Top View Camera) ..... 268  
 PreCrash system ..... 22  
 proactive speed adjustment ..... 232  
 rear cross traffic alert (RCTA) ..... 240  
 rear parking aid ..... 264  
 road sign detection system messages ..... 72  
 safety advice ..... 216  
 speed limiter ..... 221  
 system limits ..... 216  
 Trailer assist ..... 266  
 Tyre pressure monitor indicator ..... 310  
 Tyre pressure monitoring ..... 310  
 Assisted start ..... 50
- Audible warning**  
 control and warning lamps ..... 80  
 lights ..... 111  
 unbuckled seat belt ..... 16
- Auto Hold ..... 248  
 Auto Hold Function ..... 248  
 Auto Lock (central locking) ..... 91  
 Automatic car wash ..... 318  
 disconnecting the Auto Hold function ..... 248  
 Automatic dipped beam headlight control ..... 111  
 Automatic gearbox ..... 201  
 control lamp ..... 201  
 downhill assistant ..... 206  
 driving tips ..... 204  
 emergency release of the selector lever ..... 207  
 kick-down ..... 204
- launch-control program ..... 205  
 operating fault ..... 204  
 selector lever lock ..... 202  
 selector lever positions ..... 201  
 steering wheel with shift paddles ..... 203  
 tiptronic ..... 201, 203  
 towing ..... 53  
 Average fuel consumption ..... 65
- B**
- Background lighting ..... 118  
 Backrest of the rear seat  
 folding ..... 127  
 raise ..... 127  
 Bag hooks ..... 134, 140  
 Battery ..... 89  
 Before starting the vehicle ..... 12  
 Belt tightening ..... 21  
 Bicycle carrier  
 fitting onto the coverable tow hook ..... 282  
 max. load rating ..... 282  
 Blown bulbs  
 change a bulb ..... 59  
 Bluetooth® ..... 159  
 profiles ..... 160  
 Bonnet ..... 289, 291  
 opening and closing ..... 290  
 Brake fluid ..... 297  
 Brakes ..... 245  
 brake fluid ..... 297  
 brake servo ..... 245  
 braking assistant ..... 250  
 electronic parking brake ..... 247  
 emergency brake function ..... 247  
 new brake pads ..... 245
- Braking assistant ..... 250  
 Braking system  
 warning lamp ..... 245
- C**
- Camera  
 cleaning ..... 73  
 Lane Assist ..... 234
- Care  
 see Cleaning the vehicle ..... 317  
 Catalytic converter ..... 288  
 Central armrests ..... 128  
 Central locking ..... 90  
 anti-theft alarm ..... 97  
 central locking switch ..... 93  
 emergency lock ..... 100  
 remote control key ..... 92  
 selective unlocking system ..... 92  
 settings ..... 92  
 unlock and lock the vehicle (Keyless Access) ..... 93  
 Change a bulb ..... 59  
 Change the wiper blades ..... 48  
 Changing a wheel ..... 44  
 subsequent work ..... 48  
 wheel nuts ..... 45  
 Changing parts ..... 322  
 Checking levels  
 engine compartment ..... 291  
 Check lists  
 requirements for Android Auto™ ..... 168  
 requirements for Apple CarPlay ..... 167  
 requirements for MirrorLink® ..... 169  
 Childproof locks  
 electric windows ..... 106

Child seats			
group classification	31		
ISOFIX system	35		
safety instructions	32		
securing with the seat belt	38		
Top Tether system	35, 37, 38		
Cleaning the vehicle			
high pressure cleaning equipment	317		
special care	321		
vehicle exterior	319		
vehicle interior	320		
wash the vehicle	317		
Climate control			
windscreen heating	148		
Climatronic	144		
Clocks			
digital	75		
set the time	75		
Closing	90		
bonnet	290		
rear lid	102		
sunroof	108		
sunshade blind (glass roof)	109		
windows	106		
Clutch (lamp)	207		
Coming Home	115		
Connectivity	159		
WLAN access point	170		
Connectivity Box	192		
Connectors			
faults	141		
Control and warning lamps	80		
adaptive cruise control	227		
airbags	27		
airbag system	25		
alternator	300		
anti-lock brake system ABS	249		
ASR	249, 251		
audible warning	80		
braking system	245		
cruise control (GRA)	220		
EDL	249		
electromechanical steering	210		
electronic parking brake	245		
Emergency Assist	239		
emissions control	287		
engine coolant	76		
engine management	287		
engine oil	293		
ESC	249, 251		
fuel reserve	75		
gear change	207		
hill descent control	208		
Lane Assist	234		
lane departure warning (Side Assist)	241		
lights	111		
particulate filter	287, 288		
press on the brake	223, 226		
rear cross traffic alert (RCTA)	241		
refuelling	75, 285		
replacement	201		
seat belt	16		
Start-Stop	199		
steering column lock	210		
tow hook	282		
Travel Assist	238		
Tyre pressure monitor system	310		
Convenience close function windows	106		
Convenience open function windows	106		
Cooling system			
check the coolant	296		
refilling coolant	296		
Copyright	158		
Correct sitting position	13		
driver	13		
Cruise control	220		
operation	220		
CUPRA CONNECT	161		
deactivate	164		
faults	165		
legal provisions	164		
Current documentation attached	150		
<b>D</b>			
Dangers of not using the seat belt	18		
Data label	331		
Data transfer	161		
Deactivating CUPRA CONNECT services	164		
Deactivation of the front airbag	27		
Digital Cockpit	65		
information profiles	65		
navigation map	66		
Display of road signs on the instrument panel			
activate	73		
deactivate	73		
Disposal			
seat belt tensioners	21		
Distance control			
see Adaptive Cruise Control	226		

- Door cylinder ..... 100
- Door handle ..... 100
- Door lock ..... 100
- Doors ..... 99
  - child lock ..... 101
- Downhill assistance function ..... 206
- Downhill assistant ..... 206
- Drawers ..... 139
- Drink holder
  - bottle holder ..... 139
  - front ..... 139
- Drive Profile ..... 210
- Driver
  - see Correct sitting position ..... 13
- Driver alert system ..... 70
- Driving
  - driving on flooded roads ..... 215
  - economical ..... 213
  - parking on inclines ..... 253
  - park on upward slopes ..... 253
  - safe ..... 12
  - trips abroad ..... 117, 215
  - with trailer ..... 280
- Driving Assist (Travel Assist) ..... 236
  - operation ..... 238
  - problems and solutions ..... 238
  - status display ..... 237
- Driving data ..... 69
- Driving data indicator ..... 69
- Driving mode ..... 211
- Driving on flooded roads ..... 215
- Driving profile ..... 211
- DSG ..... 201
- Duplicate keys ..... 88
- Dust and pollen filter ..... 142
- Dynamic headlight range control ..... 117
- E**
- e-Call ..... 40
- Easy Open
  - special characteristics ..... 104
- Eco-driving notes ..... 74
- EDL
  - see Electronic differential lock ..... 250
- Electric
  - windows ..... 106
- Electrical accessories
  - see Power sockets ..... 140
- Electric devices ..... 140
- Electric windows ..... 106
- Electrolyte ..... 300
- Electronic differential lock ..... 250
- Electronic engine torque management (XDS) ..... 250
- Electronic immobilizer ..... 100, 198
- Electronic parking brake
  - automatic connection ..... 247
  - automatic disconnection ..... 247
  - connecting ..... 247
  - disconnecting ..... 247
  - emergency brake function ..... 247
  - lamp ..... 245
- Electronic self-locking ..... 250
- Electronic Stability Control (ESC) ..... 250
- Emergencies ..... 40
  - anti-puncture kit ..... 42
  - changing a wheel ..... 44
  - changing the battery ..... 301
  - emergency vehicle towing ..... 53
  - hazard warning lights ..... 116
  - jump leads ..... 50
  - replace a blown fuse ..... 58
  - vehicle tool kit ..... 41
- Emergency Assist ..... 238
  - Troubleshooting ..... 239
- see also Emergency Assist ..... 238
- Emergency brake function ..... 247
- Emergency braking assist system
  - malfunction ..... 224
  - operation ..... 225
  - status display ..... 223
  - system limitations ..... 226
  - temporarily deactivating ..... 225
- Emergency braking warning ..... 117
- Emergency call ..... 40
- Emergency call service ..... 40
- Emergency locking of the front passenger door ..... 100
- Emergency opening
  - driver's door ..... 100
  - rear lid ..... 105
- Emergency operation
  - front passenger door ..... 100
  - gear selector lever ..... 207
- Emissions control system
  - catalytic converter ..... 288
  - control lamp ..... 287
  - particulate filter ..... 288
- Engine management ..... 301
- Engine
  - assisted start ..... 50
  - noise ..... 196
  - running in ..... 212

- Start-Stop system ..... 199  
 start (driver instructions with the mechanical contact) ..... 198
- Engine and ignition  
 automatic ignition disconnection ..... 195  
 emergency start ..... 198  
 My Beat ..... 195  
 preheat the engine ..... 196  
 starting the engine ..... 196  
 starting the engine with Press & Drive ..... 196  
 switching off the engine ..... 197
- Engine compartment ..... 289, 291  
 battery ..... 299  
 brake fluid ..... 297  
 coolant ..... 295, 296  
 engine oil ..... 294  
 opening and closing ..... 290  
 safety instructions ..... 289  
 window washer tank ..... 298
- Engine coolant ..... 295  
 check the level ..... 296  
 control lamp ..... 76  
 G12evo ..... 295  
 G12 plus-plus ..... 295  
 G13 ..... 295  
 specifications ..... 295  
 temperature indicator ..... 76  
 warning lamp ..... 76
- Engine failure  
 control lamp ..... 287
- Engine management ..... 287  
 control lamp ..... 287
- Engine oil  
 change ..... 292, 295  
 checking the oil level ..... 293  
 consumption ..... 293  
 dipstick ..... 293  
 inspection service ..... 292  
 maintenance frequencies ..... 292  
 refill ..... 294  
 specifications ..... 292
- Engine oil pressure  
 control lamp ..... 293
- Engine specifications ..... 333
- Environment  
 ecological driving ..... 213  
 environmental compatibility ..... 325  
 refuelling ..... 285
- Environmental tip  
 refuelling ..... 285
- Equipment  
 telephone interface ..... 188
- ESC  
 electronic stability control (ESC) ..... 250  
 multi-collision brake ..... 251  
 Sport mode ..... 251
- Event Data Recorder ..... 325
- Exhaust gases ..... 287
- Exterior lighting  
 change a bulb ..... 59
- Exterior mirrors  
 driving with a trailer ..... 276  
 folding ..... 121  
 heated ..... 121  
 settings ..... 121
- Exterior view ..... 7, 8
- External antenna ..... 323
- external audio sources  
 adapting the playback volume ..... 157
- F**  
 Fabrics: clean ..... 320
- Factors that have a negative influence on safe driving ..... 12
- Fastening rings ..... 133
- Filling capacities  
 fuel tank ..... 331  
 window washer tank ..... 331  
 window washer water ..... 298
- Filling the tank ..... 285
- Fog lights with cornering light function ..... 115
- Four-wheel drive ..... 213  
 snow chains ..... 213  
 towing ..... 53  
 winter tyres ..... 213
- Frequency bands ..... 175
- Front airbags ..... 25
- Front Assist  
 see Emergency braking assist system ..... 223
- Front passenger front airbag  
 control lamp ..... 25
- Fuel  
 fuel gauge ..... 75  
 identification ..... 286  
 petrol ..... 286  
 refuelling ..... 285  
 saving ..... 213
- Fuel consumption  
 inertia disconnection ..... 213  
 why does consumption increase? ..... 287
- Fuel gauge ..... 75  
 control lamp ..... 75
- Fuel tank cap  
 opening and closing ..... 285

- Fuel tank flap  
 opening and closing ..... 285
- Full-LED headlights ..... 59
- Full Link ..... 166  
 applications ..... 167  
 settings ..... 167  
 symbols ..... 167
- Fuses ..... 56  
 colour coded ..... 57  
 fuse box ..... 56, 57  
 preparations for replacing fuses ..... 58  
 recognise blown fuses ..... 58  
 replace ..... 58
- G**
- Gear-change recommendation ..... 208
- Gearbox DSG  
 see Automatic gearbox ..... 201
- Gear indication ..... 208
- Glove compartment ..... 139
- H**
- Handbrake  
 see Electronic parking brake ..... 247
- Hangers ..... 140
- Hazard warning lights ..... 116
- HDC  
 see Hill descent control (HDC) ..... 208
- Head-on collisions and the laws of physics ... 18
- Headlights  
 change a bulb ..... 59  
 headlight washer ..... 119  
 trips abroad ..... 117
- Headrest ..... 125, 126
- Hill descent control (HDC).  
 control lamp ..... 208
- Horn ..... 63
- I**
- Identification of fuels ..... 286
- Identifying letters on engine (LDM)  
 display ..... 68
- Identity accreditation ..... 163
- Inertia mode ..... 206
- Information profiles ..... 65
- Infotainment ..... 82, 150  
 adapt menus ..... 156  
 Android Auto™ ..... 168  
 Apple CarPlay ..... 167  
 before first use ..... 150  
 connecting and disconnecting ..... 156  
 customise ..... 156  
 customised menus ..... 156  
 drop-down menu ..... 156  
 executing functions ..... 156  
 function buttons ..... 83  
 initial configuration ..... 84  
 Internet access ..... 171  
 Media mode ..... 178  
 MirrorLink® ..... 169  
 navigation ..... 181  
 operating ..... 156  
 overview and controls ..... 154  
 Radio mode ..... 174  
 safety instructions ..... 150  
 share a WLAN connection ..... 170  
 sound settings ..... 157  
 system settings ..... 157  
 telephone interface ..... 188
- vehicle information ..... 85  
 vehicle settings ..... 86  
 Wi-Fi Protected Setup (WPS) ..... 171  
 WLAN ..... 170
- Infotainment system  
 see Infotainment ..... 82
- Inspection ..... 292, 314
- Inspection reminder ..... 77
- Inspection service ..... 292
- Instrument panel ..... 64, 65  
 control and warning lamps ..... 80  
 digital (Digital Cockpit) ..... 65  
 display ..... 65  
 instruments ..... 65  
 menu structure ..... 68  
 service intervals display ..... 77  
 status display ..... 66, 68  
 use with the multifunction steering wheel . 78
- Instrument panel display ..... 65, 66
- Instrument panel lighting ..... 118
- Instruments ..... 65
- Interior mirror  
 anti-dazzle ..... 121
- Interior monitoring and the anti-tow system  
 activation ..... 98
- Interior view ..... 11
- Interlock button ..... 202
- ISOFIX ..... 35
- ISOFIX system ..... 35
- J**
- Jack ..... 41  
 position points ..... 46
- Jump leads ..... 50



- Jump start ..... 50  
 description ..... 50
- K**
- Keyless Access  
 Easy Open ..... 93  
 Keyless Entry ..... 93  
 Keyless Exit ..... 93  
 Press & Drive ..... 195  
 special characteristics ..... 95  
 starting the engine ..... 196  
 unlocking and locking the vehicle ..... 93
- Keyless Access lock and ignition system:  
 see Keyless Access ..... 93
- Keys  
 assign a key ..... 88  
 changing the battery ..... 89  
 instructions for the driver (mechanical  
 contact) ..... 198  
 remote control ..... 88  
 spare key ..... 88  
 synchronise ..... 90  
 unlock and lock ..... 92, 100  
 vehicle key ..... 88
- Key switch ..... 27
- Kick-down  
 automatic gearbox ..... 204
- L**
- Lane Assist ..... 234  
 control and warning lamp ..... 234
- Lane assist Plus ..... 242
- Lane Assist system  
 see Lane Assist ..... 234
- Lane departure warning (Side Assist)  
 control lamp ..... 241  
 driving situations ..... 242  
 how it works ..... 241  
 indication on the exterior mirror ..... 242
- Launch-control (automatic transmission) .. 205
- Leather: clean ..... 320
- Leaving a parking space with the parking as-  
 sist system ..... 258
- Leaving Home ..... 115
- Legal provisions ..... 164
- Levels control ..... 331
- Licenses ..... 158
- Lift the vehicle ..... 46
- Light Assist ..... 114
- Light range control ..... 117
- Lights ..... 111  
 audible warnings ..... 111  
 AUTO ..... 111  
 change a bulb ..... 59  
 coming home ..... 115  
 control and warning lamps ..... 111  
 control lighting ..... 118  
 controlling the lights ..... 111  
 cornering light ..... 115  
 daylight ..... 112  
 dipped beam headlights ..... 111  
 fog light ..... 113  
 fog light with cornering light function .... 115  
 headlight range control ..... 117  
 instrument lighting ..... 118  
 interior lights ..... 118  
 leaving home ..... 115  
 main beam headlight lever ..... 113  
 main beam headlights ..... 111
- motorway light ..... 112
- reading lights ..... 118
- side lights ..... 111
- switch ..... 111
- switching on and off ..... 111
- turn signal lever ..... 113
- welcome light ..... 116
- Loading the luggage compartment  
 fastening rings ..... 133  
 general advice ..... 129  
 luggage compartment ..... 102, 129  
 positioning the load ..... 129  
 positioning the luggage ..... 129  
 roof carrier system ..... 137  
 trailer ..... 279  
 trapdoor for transporting long objects .... 135
- Load on the roof ..... 137  
 technical data ..... 137
- Lock and unlock ..... 93  
 in the locking cylinder ..... 100  
 with the central locking switch ..... 93
- Luggage compartment ..... 102, 129  
 electric opening and closing ..... 102  
 emergency unlocking ..... 105  
 features of the electric rear lid ..... 103  
 luggage compartment lighting ..... 118  
 net bag ..... 134  
 net partition ..... 135  
 opening and closing controlled by sensors  
 (Easy Open) ..... 104  
 storing the rear shelf ..... 130  
 variable luggage compartment floor ..... 132
- Luggage compartment floor ..... 132
- Luggage compartment shelf  
 storing ..... 130

- Lumbar support ..... 123
- M**
- Main beam assist ..... 114
- Main beam headlight lever ..... 113
- Maintenance  
  see Service ..... 314
- Maintenance frequencies ..... 292
- Malfunction  
  adaptive cruise control ..... 231  
  assisted parking system (Park Assist) ..... 253  
  clutch ..... 207  
  emergency brake assistance system (Front Assist) ..... 224  
  PreCrash system ..... 23  
  replacement ..... 207  
  sunroof ..... 108  
  towing device ..... 277
- Mats ..... 16
- Media Mode ..... 178
- Memory function ..... 126
- MirrorLink®  
  Disconnecting ..... 169  
  establish connection ..... 169  
  menu ..... 169  
  requirements ..... 169  
  settings ..... 167  
  special characteristics ..... 170
- Mirrors  
  adjusting the exterior mirrors ..... 121  
  anti-dazzle interior ..... 121  
  see also Mirrors ..... 121
- Mobile ..... 323
- Mobile phones ..... 323
- Mobile Signal Amplifier ..... 192
- Multi-collision brake ..... 251
- Multifunction display ..... 69
- Multimedia ..... 174, 193  
  favourites ..... 179  
  play ..... 179  
  select source ..... 179  
  use streaming services ..... 180
- My Beat ..... 195
- N**
- Navigation ..... 181  
  decrease the navigation map ..... 182  
  detailed view ..... 187  
  edit route ..... 186  
  enter an address for a guide destination ..... 184  
  favourite destinations ..... 185  
  frequent destinations ..... 185  
  functions ..... 183  
  function: entering destination ..... 184  
  increase the navigation map ..... 182  
  last destinations ..... 185  
  learn usage pattern ..... 187  
  limitations ..... 182  
  managing the map ..... 182  
  map ..... 182, 185  
  navigation announcements ..... 181  
  offroad mode ..... 185  
  Other options ..... 187  
  route details ..... 186  
  saved data ..... 182, 187  
  saved destinations ..... 185  
  save destination ..... 185  
  split screen ..... 187  
  symbols ..... 183  
  use contact details ..... 186
- use the map ..... 185  
  use the map to enter the destination ..... 185
- Net bag  
  luggage compartment ..... 134
- Net for luggage  
  luggage compartment ..... 134
- Net partition ..... 135
- Noise  
  brakes ..... 245  
  ESC ..... 250  
  parking brake ..... 247  
  tyres ..... 304, 308
- Number of seats ..... 14
- O**
- Octane (petrol) ..... 286
- Odometer ..... 65  
  partial ..... 65, 67  
  total ..... 65, 67
- Oil change ..... 295
- One-touch signalling function ..... 113
- Online services ..... 161
- Opening ..... 90  
  bonnet ..... 290  
  rear lid ..... 102  
  sunroof ..... 108  
  sunshade blind (glass roof) ..... 109  
  tank cap ..... 285  
  windows ..... 106
- Opening and closing ..... 90  
  bonnet ..... 290  
  by remote control ..... 92  
  doors ..... 99  
  in the locking cylinder ..... 100  
  rear lid ..... 102

- rear lid with electric opening and closing . . . . . 102
  - sunroof . . . . . 108
  - tank cap . . . . . 285
  - windows . . . . . 106
    - with the central locking switch. . . . . 93
  - Operating fault
    - automatic gearbox . . . . . 204
  - Operation in winter
    - battery . . . . . 299
    - heated windscreen washer jets . . . . . 119
    - salt on the roads . . . . . 120
    - snow chains . . . . . 309
    - tyres . . . . . 308
  - Original accessories . . . . . 316
  - Original Spare Parts . . . . . 316
  - Overview
    - of the instruments . . . . . 65
  - Overview (left hand drive) . . . . . 9
  - Overview (right hand drive) . . . . . 10
  - Ownership accreditation . . . . . 163
- P**
- Painting the vehicle
    - care . . . . . 319
  - Panoramic roof
    - see Sunroof . . . . . 108
  - Park Assist
    - see the assisted parking system (Park As-  
sist) . . . . . 253
  - Parking . . . . . 252
    - automatic gearbox . . . . . 204
    - with the assisted parking system (Park As-  
sist) . . . . . 257
  - Parking aid
    - automatic activation . . . . . 262
    - braking during the manoeuvre . . . . . 263
    - fault . . . . . 263, 265
    - parking aid plus . . . . . 261
    - rear parking aid . . . . . 264
    - see the assisted parking system (Park As-  
sist) . . . . . 253
    - sensors and camera: clean . . . . . 319
    - setting the indications and audio sig-  
nals . . . . . 263, 265
    - surroundings warning . . . . . 261
    - towing device . . . . . 265
    - trailer mode . . . . . 263
    - visual indication . . . . . 262, 265
  - Parking aid system
    - see Parking aid . . . . . 259, 261, 264
  - Parking aid system (Park Assist) . . . . . 253
    - angle parking . . . . . 257
    - automatic brake operation . . . . . 259
    - automatic interruption . . . . . 254
    - conditions for leaving a parking space . . . . . 258
    - leaving a parking space (only when parallel  
parked) . . . . . 258
    - malfunction . . . . . 253
    - parallel parking . . . . . 257
    - parking conditions . . . . . 257
    - stop early . . . . . 254
  - Parking distance warning system
    - see Parking aid . . . . . 259, 261, 264
  - ParkPilot
    - see Parking aid . . . . . 259, 261, 264
  - Partial odometer . . . . . 68
  - Particulate filter . . . . . 288
  - Pedals . . . . . 14, 16
  - Peripheral view system (Top View Camera) . . . . . 268
    - display . . . . . 270
    - menus . . . . . 271
    - modes . . . . . 271
    - special characteristics . . . . . 270
    - usage instructions . . . . . 270
  - Petrol
    - additives . . . . . 286
    - particulate filter . . . . . 288
    - refuelling . . . . . 286
  - Places with risk of explosion . . . . . 189
  - Places with special regulations . . . . . 189
  - Power socket
    - faults . . . . . 141
  - Power sockets . . . . . 140
    - trailer . . . . . 277
  - Power steering
    - see Steering . . . . . 209
  - PreCrash system . . . . . 22
    - Front Assist monitoring system . . . . . 22
    - malfunction . . . . . 23
    - selecting the driving profile . . . . . 23
    - status display . . . . . 23
  - Preheat the engine . . . . . 196
  - Press & Drive
    - start button . . . . . 195
    - starting the engine . . . . . 196
  - Proactive speed adjustment . . . . . 232
    - activation . . . . . 233
    - driving . . . . . 233
    - limitations . . . . . 232
    - problems and solutions . . . . . 233
  - Problems and solutions
    - Trailer assist . . . . . 268

## R

- Radar sensors ..... 217
- Radio ..... 174
  - equipment ..... 175
  - frequency bands ..... 175
  - preset buttons ..... 175
  - symbols ..... 175
  - Traffic information (TP) ..... 176
  - tune station ..... 175
- Radio-operated remote control
  - see Keys ..... 88
- Radio mode ..... 174
- Radio screen: clean ..... 320
- Radio telephones ..... 323
- Rain sensor ..... 120
  - function control ..... 120
- Raise the vehicle ..... 46
- RCTA ..... 243
  - see Rear cross traffic alert (RCTA) ..... 240
- Rear cross traffic alert (RCTA) ..... 240, 243
  - control lamp ..... 241
- Rear fog light
  - control lamp ..... 111
- Rear lid ..... 102, 105
  - see also Luggage compartment ..... 102
- Rear mounting
  - towing device ..... 283
- Rear parking aid ..... 264
- Rear Traffic Alert ..... 243
- Rear View Camera ..... 272
- Rear window wiper ..... 118
- Refuelling
  - control lamp ..... 75
  - fuel gauge ..... 75
  - opening the fuel tank flap ..... 285
- Releasing the seat belt ..... 19
- Remote control key
  - unlock and lock ..... 92
- Repair work ..... 322
- Requirements for Apple CarPlay ..... 167
- Reverse assist ..... 272
  - display ..... 273
  - parking ..... 273
  - special characteristics ..... 273
  - usage instructions ..... 273
- Reverse assist system ..... 272
- Reverse (automatic gearbox) ..... 202
- Revolution counter ..... 65, 75
- Road signs
  - shown on the display ..... 72
- Road signs detection system ..... 72
  - how it works ..... 72
  - limited operation ..... 73
  - shown on the display ..... 72
  - speed warning ..... 73
  - trailer ..... 73
  - windscreen damage ..... 73
- Roof carrier ..... 136
  - fix the crossbars ..... 137
- Roof carrier system ..... 136
- Roof rack ..... 136
- Rotation direction
  - tyres ..... 48
- Running in
  - new brake pads ..... 245
  - new engine ..... 212
  - new tyres ..... 303

## S

- S-PIN ..... 163
- Safe ..... 198
- Safe driving ..... 12
- Safe security system ..... 96
- Safety
  - child safety ..... 30
  - child seats ..... 30
  - safe driving ..... 12
- Safety equipment ..... 12
- Safety instructions ..... 150
  - head-protection airbags ..... 29
  - seat belt tensioners ..... 21
  - side airbags ..... 28
  - using child seats ..... 32
  - using seat belts ..... 17
- Save fuel
  - inertia mode ..... 206
- Screen
  - clean ..... 158
- Seat belts ..... 16
  - adjusting the seat belt ..... 20
  - adjustment ..... 19
  - control lamp ..... 16
  - protective function ..... 17
  - purpose ..... 16, 23
  - safety instructions ..... 17
  - unfastened ..... 18
- Seat belt tensioners ..... 21
  - control lamp ..... 25

- Seat heating ..... 147
- SEAT Ident ..... 163
- Seats
  - adjusting the headrests ..... 125
  - electric settings ..... 124
  - fitting the headrest ..... 126
  - folding down and raising the rear seat
    - backrest ..... 127
    - heating ..... 147
  - incorrect positions ..... 14
  - manual adjustment ..... 123
  - memory function ..... 126
  - number of seats ..... 14
  - removing the headrest ..... 126
- Selective unlocking system ..... 92
- Selector lever lock ..... 202
- Selector lever (automatic gearbox)
  - emergency unlocking ..... 207
  - positions ..... 201
- Selling the vehicle ..... 164
- Service
  - Digital Maintenance plan ..... 314
  - flexible service ..... 314
  - inspection ..... 314
  - oil change service ..... 314
  - proof of Service ..... 314
  - services ..... 314
  - service sets ..... 316
  - service works ..... 314
  - set service intervals ..... 314
  - terms of use ..... 315
- Service interval display ..... 68, 315
- Service intervals ..... 77
- Service Menu
  - identifying letters on engine ..... 68
  - restart the oil service ..... 68
  - restart Trip ..... 68
  - service intervals display ..... 68
  - time ..... 68
- Service Mobility ..... 316
- Service notification: consult ..... 77
- Set of vehicle keys ..... 88
- Shift paddles (automatic transmission) ..... 203
- Signal amplifier ..... 192
- Snow chains ..... 309
  - four-wheel drive ..... 213
- Sound settings ..... 157
- Sound system ..... 159
- Spare parts ..... 322
- Spare wheel ..... 312
- Special characteristics
  - Android Auto™ ..... 169
  - Apple CarPlay ..... 168
  - high pressure cleaning equipment ..... 281
  - MirrorLink® ..... 170
  - peripheral view system (Top View Camera) ..... 270
  - towing ..... 51, 54
  - tow start ..... 51
  - trailer mode ..... 280
- Speed limiter ..... 221
  - indication on display ..... 221
  - operating ..... 222
- Speed symbol ..... 304
- Speed warning ..... 70
- Sport Mode ..... 251
- Stabilisation of the towing vehicle and trailer combination ..... 280
- Start-Stop ..... 199
- Start-Stop system
  - disconnect and connect manually ..... 201
  - driver indications ..... 199
  - how it works ..... 199
  - lamps ..... 199
  - stopping and starting the engine ..... 199
  - the engine does not turn off ..... 199
  - the engine starts by itself ..... 199
- Starter button ..... 195
- Start the engine by towing ..... 52
  - special characteristics ..... 51
- Status display ..... 68
  - adaptive cruise control ..... 229
  - compass indication ..... 67
  - doors, bonnet and rear lid open ..... 67
  - Drive Profile ..... 210
  - Eco-driving notes ..... 74
  - Emergency brake assistance system (Front Assist) ..... 223
  - gear-change recommendation ..... 67
  - instrument panel ..... 66
  - odometer ..... 67
  - outside temperature ..... 67
  - PreCrash system ..... 23
  - road signs ..... 72
  - selector lever positions ..... 67, 201
  - service intervals ..... 77
  - speed limiter ..... 221
  - speed warning ..... 67
  - time ..... 75
  - Travel Assist ..... 237
  - Tyre pressure monitoring ..... 310
  - warning and information messages ..... 70

- Steering  
 control lamp ..... 210  
 electromechanical steering ..... 209  
 steering assist ..... 209
- Steering assist ..... 209
- Steering wheel  
 adjust ..... 15  
 controls ..... 87  
 heating ..... 148  
 multifunction ..... 87  
 shift paddles (automatic transmission) ... 203
- Steering wheel heating ..... 148
- Storage compartment ..... 138  
 drawers ..... 139  
 glove compartment ..... 139  
 glove compartment light ..... 118  
 on-board documentation ..... 139  
 on the front passenger side ..... 139  
 other object holders ..... 140
- Storage compartment accessories  
 see Storage ..... 138
- Storage of accident data ..... 325
- Storing objects ..... 129  
 bag hooks ..... 134  
 fastening rings ..... 133  
 loading the trailer ..... 279  
 net bag ..... 134  
 net partition ..... 135  
 positioning the load ..... 129  
 positioning the luggage ..... 129  
 roof carrier ..... 136  
 roof carrier system ..... 136, 137  
 trailer ..... 274  
 trailer mode ..... 280  
 trapdoor for transporting long objects .... 135
- Sun blind ..... 123
- Sun protection ..... 123
- Sunroof ..... 108  
 anti-trap function ..... 110  
 closing ..... 108  
 malfunction ..... 108  
 opening ..... 108  
 sunshade blind ..... 109
- Sunshade blind  
 anti-trap function (glass roof) ..... 110  
 sunroof ..... 109
- Switch  
 hazard warning lights ..... 116
- Switching off  
 telephone ..... 189  
 telephone interface ..... 189
- System settings ..... 157
- T**
- Tail lights  
 change a bulb ..... 59
- Technical data ..... 331  
 fuel consumption ..... 331  
 load on the roof ..... 137  
 vehicle dimensions ..... 334  
 vertical load on the tow hitch ..... 274  
 weights ..... 331
- Technical modifications ..... 323
- Telephone  
 contacts ..... 192  
 disconnecting ..... 189  
 favourites ..... 192  
 pairing a mobile phone ..... 190  
 Phone book ..... 192  
 send messages ..... 191
- speed dial buttons ..... 192  
 to call ..... 191
- Telephone interface ..... 188  
 places with risk of explosion ..... 189
- Temperature indicator  
 exterior ..... 67
- Time  
 adjust ..... 68, 75
- Tiptronic (automatic transmission) .... 201, 203
- To change the battery  
 of the vehicle key ..... 89
- Top Tether ..... 35, 37, 38
- Top Tether System ..... 35, 37, 38
- Top View Camera  
 see the Peripheral view system (Top View  
 Camera) ..... 268
- Torque  
 wheel nuts ..... 47
- Touch screen ..... 154
- Touch zones ..... 154
- Towable loads  
 loading the trailer ..... 279
- Tow cable ..... 276, 278
- Tow hook  
 control lamp ..... 282  
 unlocking electrically ..... 281
- Towing device  
 fitting a bicycle carrier ..... 282  
 fitting later ..... 283  
 malfunction ..... 277  
 tow hook with electric unlocking ..... 281
- Towing the vehicle ..... 51, 53  
 automatic gearbox ..... 53  
 four-wheel drive ..... 53  
 front towline anchorage ..... 54

- rear towline anchorage ..... 55
  - special characteristics ..... 51, 54
  - tow bar ..... 53
  - towing cable ..... 53
  - towing prohibited ..... 53
  - with towing device ..... 53
  - Traction control system ..... 250
  - Trademarks ..... 158
  - Traffic information (TP) ..... 176
  - Traffic programme
    - see Traffic information (TP) ..... 176
  - Trailer ..... 274
    - adjusting the headlights ..... 280
    - anti-theft alarm ..... 278
    - connecting ..... 277
    - exterior mirrors ..... 276
    - hitching ..... 277
    - LED tail lights ..... 276, 278
    - loading ..... 279
    - malfunction ..... 277
    - parking aid ..... 263, 265
    - power socket ..... 277
    - retrofitting a towing bracket ..... 283
    - special characteristics ..... 244
    - stabilisation of the towing vehicle and trailer combination ..... 280
    - tail lights ..... 276, 278
    - technical requirements ..... 276
    - towable loads ..... 279
    - towing cable ..... 276, 278
    - Trailer assist ..... 266
    - trailer mode ..... 280
    - unlocking the tow hook electrically ..... 281
    - vertical load on the tow hitch ..... 274, 279
  - Trailer Assist ..... 266
    - automatic brake operation ..... 267
    - check list ..... 266
    - malfunction ..... 266
    - operating ..... 267
    - problems and solutions ..... 268
    - see Trailer Assist ..... 266
  - Trailer mode
    - see Trailer ..... 274
  - Transportation of children ..... 30
  - Trapdoor for transporting long objects ..... 135
  - Travel Assist
    - see Driving Assist (Travel Assist) ..... 236
  - Trips abroad
    - headlights ..... 117
    - petrol ..... 215
  - Turning off the lights ..... 111
  - Turning on the lights ..... 111
  - Turn signal lever ..... 113
  - Tyre Mobility System
    - see Anti-puncture kit ..... 42
  - Tyre pressure ..... 306
  - Tyre pressure monitor system ..... 310
  - Tyre pressure monitor systems
    - Tyre pressure monitor indicator ..... 310
  - Tyre profile ..... 307
  - Tyre repair kit ..... 41
    - see also Anti-puncture kit ..... 42
  - Tyre repairs ..... 42
  - Tyres
    - accessories ..... 304
    - change ..... 44
    - directional tread pattern ..... 48
    - foreign objects inserted ..... 304
    - for winter ..... 308
  - new tyres ..... 305
  - speed symbol ..... 304
  - tread wear indicators ..... 307
  - tyre pressure ..... 306
  - useful life ..... 306
  - with directional tread pattern ..... 304
  - Tyre tread depth ..... 307
  - Tyre wear ..... 307
- ## U
- Unlock and lock ..... 93
    - by remote control ..... 92
    - doors ..... 99
    - with the central locking switch ..... 93
  - USB ..... 193
  - USB port ..... 193
- ## V
- Vanity mirror ..... 123
  - Variable luggage compartment floor ..... 132
  - Vehicle
    - data label ..... 331
    - identification data ..... 331
    - identification number ..... 331
    - lending or selling ..... 164
    - parking on inclines ..... 253
    - parking on upward slopes ..... 253
    - raise ..... 46
    - unlocking and locking (Keyless Access) ..... 93
    - vehicle ID number ..... 331
  - Vehicle care
    - wiper blade service position ..... 48
  - Vehicle conservation products ..... 317
  - Vehicle dimensions ..... 334

Vehicle information .....	85	changing a wheel .....	44	Winter conditions	
Vehicle location .....	164	new wheels .....	305	sunroof .....	108
Vehicle maintenance .....	317	snow chains .....	309	trailer .....	274
Vehicle seats .....	14	spare wheel .....	312	Winter tyres .....	308
Vehicle settings .....	86	wheel nuts .....	308	four-wheel drive .....	213
Vehicle tool kit .....	41	Wheel spanner .....	41	Wiper and rear window wiper blades	
Vehicle wallet compartment .....	139	Wheel trim		cleaning .....	49, 319
Vertical load on the tow hitch .....	274	remove .....	45	replacement .....	49
loading the trailer .....	279	Wi-Fi .....	159	service position .....	48
voice control .....	172	Window controls .....	106	Wireless Charger .....	192
Android Auto™ .....	169	Windows		Wireless charging .....	192
Siri™ (Apple CarPlay™) .....	168	automatic opening/closing .....	106	WLAN .....	170
Volume		automatic operation .....	106	<b>X</b>	
set for external audio sources .....	157	convenience closing .....	106	XDS .....	250
<b>W</b>		convenience opening .....	106		
Warning symbols		Window washer			
see Control and warning lamps .....	80	window washer lever .....	118		
Warning triangle .....	116	Window washer system .....	298		
Warranty .....	317	Window washer water			
Washing the vehicle		check .....	298		
conserving the exterior of the vehicle .....	317	filling quantities .....	298		
high pressure cleaning equipment .....	317	refill .....	298		
sensors .....	253	Windscreen			
special characteristics .....	104	heating .....	148		
Weights .....	331	Windscreen heating .....	144, 148		
Welcome light .....	116	Windscreen washer .....	118		
Wheel balance .....	306	Windscreen wipers .....	118		
Wheel nuts .....	45, 308	functions .....	119		
anti-theft device .....	45	headlight washer system .....	119		
caps .....	45	lift the blade .....	48		
torque .....	47	rain sensor .....	120		
Wheels		reposition the blade .....	48		
change .....	44, 47	service position .....	48		
changing .....	307	special characteristics .....	118		
		thermal washing ejectors .....	119		



SEAT S.A. is permanently concerned about continuous development of its types and models. For this reason we ask you to understand, that at any given time, changes regarding shape, equipment and technique may take place on the car delivered. For this reason no right at all may derive based on the data, drawings and descriptions in this current handbook.

All texts, illustrations and standards in this handbook are based on the status of information at the time of printing. Except for error or omission, the information included in the current handbook is valid as of the date of closing print.

Re-printing, copying or translating, whether total or partial is not allowed unless SEAT allows it in written form.

SEAT reserves all rights in accordance with the "Copyright" Act.

All rights on changes are reserved.

 This paper has been manufactured using bleached non-chlorine cellulose.

© SEAT S.A. - Reprint: 15.06.21

Inglés 575012720CG (06.21)



575012720CG

